

Drawings Not To Scale

EWU Building Floor Plans



EASTERN
WASHINGTON UNIVERSITY



start something **big**

Updated 2-01-2022

DRAWINGS ARE NOT TO SCALE

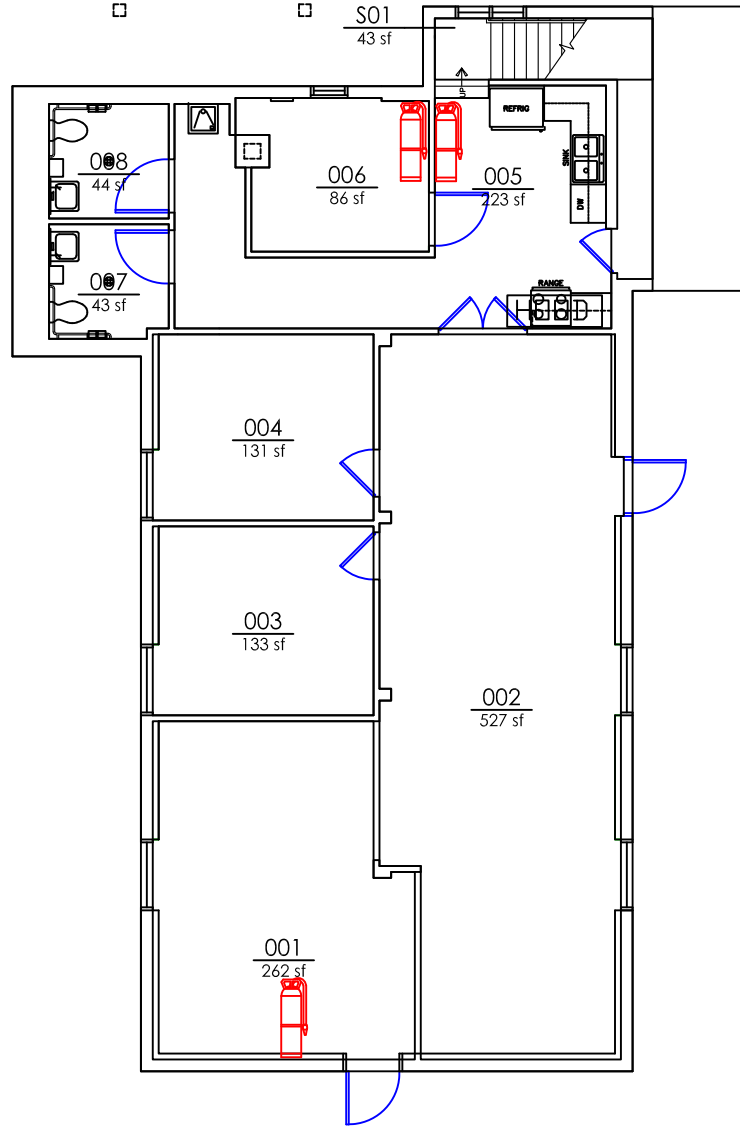
 **BASEMENT**
INDIAN EDUCATION CENTER



-  HOOD EXTINGUISHER
-  FICM Code 210 Classroom
-  FICM Code 110 Classroom

-  = FIRE EXTINGUISHER
-  = AED
-  = FIRE DEP. CONNECTION
-  = LOCK BOX
-  = FIRE ALARM CONTROL PANEL
-  = SPRINKLER HEADER
-  = SPRINKLER RISER
-  = Bottle Filler

DATE REVISED	ADDRESS	Square Feet	BLDG NO	(AIEC) AMERICAN INDIAN EDUCATION CENTER BASEMENT	FLOOR
09/29/2020	706 5th Street	1724	1193		0

DRAWINGS ARE NOT TO SCALE



MAIN FLOOR
INDIAN EDUCATION CENTER

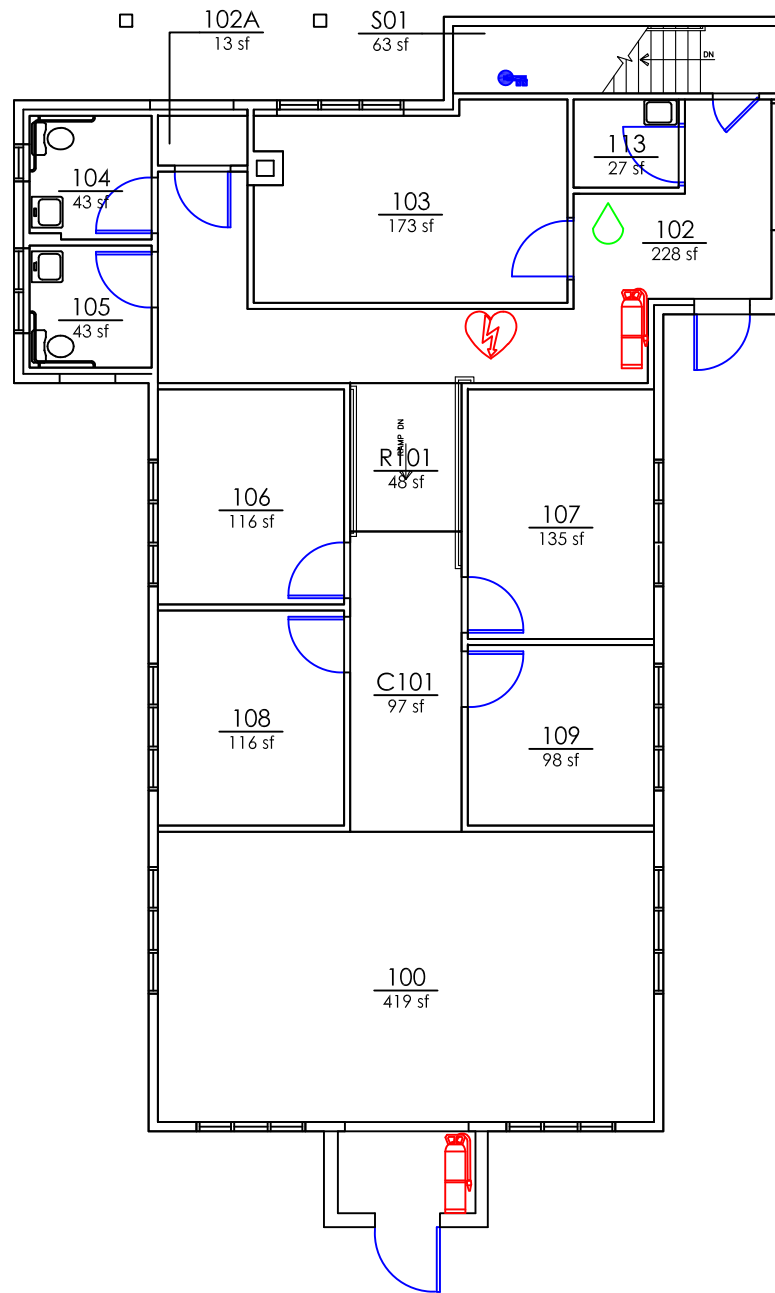

- FICM Code 210 Classroom
- FICM Code 110 Classroom

- = FIRE EXTINGUISHER
- = AED
- = FIRE DEP. CONNECTION
- = LOCK BOX
- = FIRE ALARM CONTROL PANEL
- = SPRINKLER HEADER
- = SPRINKLER RISER
- = Bottle Filler

DATE REVISED
09/29/2020

ADDRESS
706 5th Street

Square Feet
1813



BLDG NO
1193

(AIEC) AMERICAN INDIAN EDUCATION
CENTER FIRST FLOOR

FLOOR
1

DRAWINGS ARE NOT TO SCALE



 FICM Code 210 Classroom
 FICM Code 110 Classroom

 = FIRE EXTINGUISHER  = AED  = FIRE DEP. CONNECTION  = LOCK BOX  = FIRE ALARM CONTROL PANEL  = SPRINKLER HEADER  = SPRINKLER RISER  = Bottle Filler

DATE REVISED
02/01/2022

ADDRESS
1275 SWOOP LN

Square Feet
30574

BLDG NO
7008

(ALB) ALBERS COURT FIRST FLOOR

FLOOR
1



NORTH BUILDING BASEMENT FLOOR
ANNA MARIA APARTMENTS



FICM Code 210 Classroom
 FICM Code 110 Classroom

= FIRE EXTINGUISHER = AED = FIRE DEP. CONNECTION = LOCK BOX = FIRE ALARM CONTROL PANEL = SPRINKLER HEADER **R** = SPRINKLER RISER = Bottle Filler

DATE REVISED
09/29/2020

ADDRESS
922 Washington Street

Square Feet
3090

BLDG NO
1216

(AMN) ANNA MARIA APPARTMENTS
NORTH BUILDING BASEMENT

FLOOR
0



**NORTH BUILDING FIRST FLOOR
ANNA MARIA APARTMENTS**

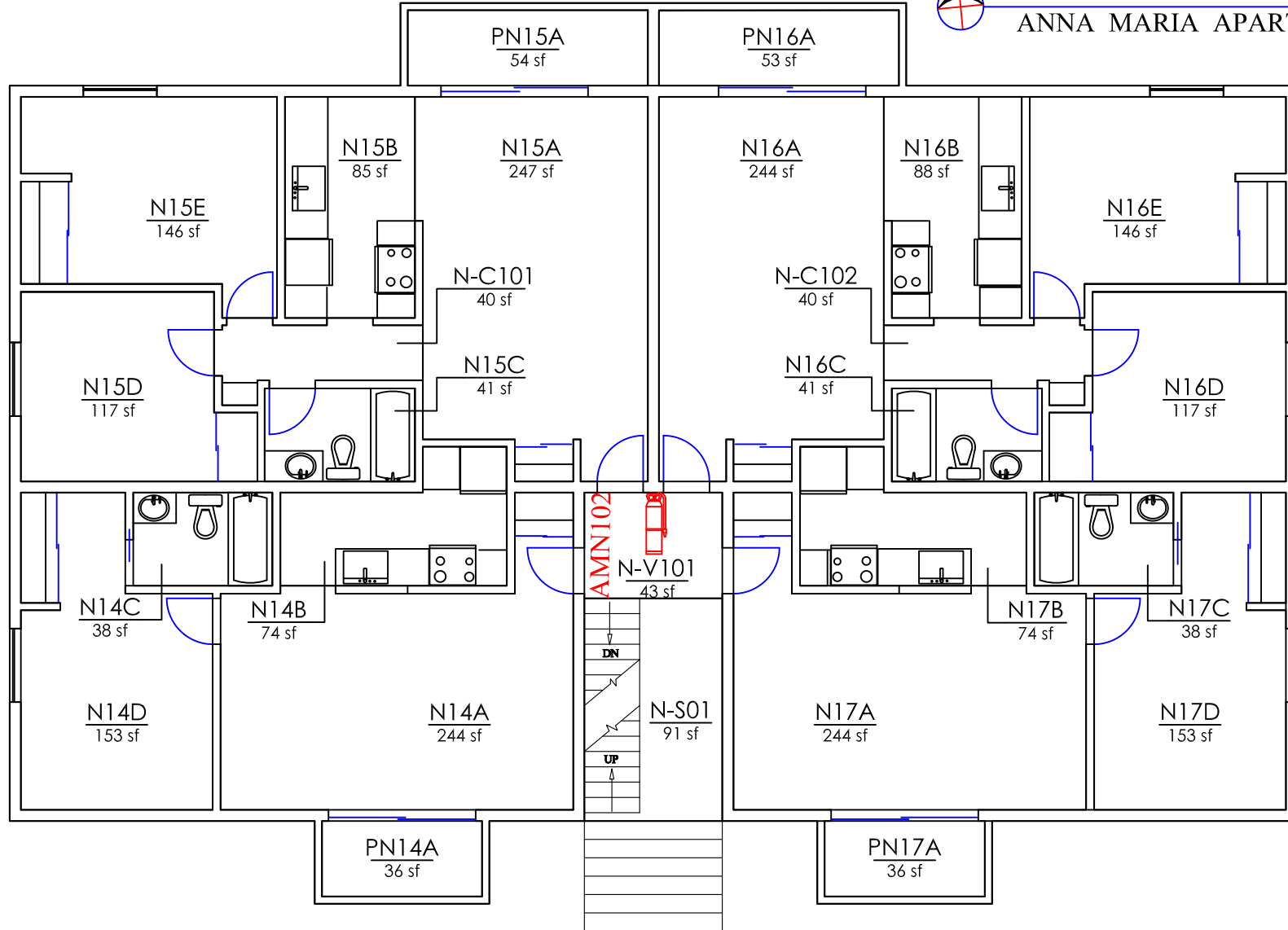

- FICM Code 210 Classroom
- FICM Code 110 Classroom

- = FIRE EXTINGUISHER
- = AED
- = FIRE DEP. CONNECTION
- = LOCK BOX
- = FIRE ALARM CONTROL PANEL
- = SPRINKLER HEADER
- = SPRINKLER RISER
- = Bottle Filler

DATE REVISED
09/30/2020

ADDRESS
922 Washington
Street

Square Feet
3009

BLDG NO
1216

**(AMA) ANNA MARIA APARTMENTS
NORTH BUILDING FIRST FLOOR**

FLOOR
1



NORTH BUILDING SECOND FLOOR
ANNA MARIA APARTMENTS

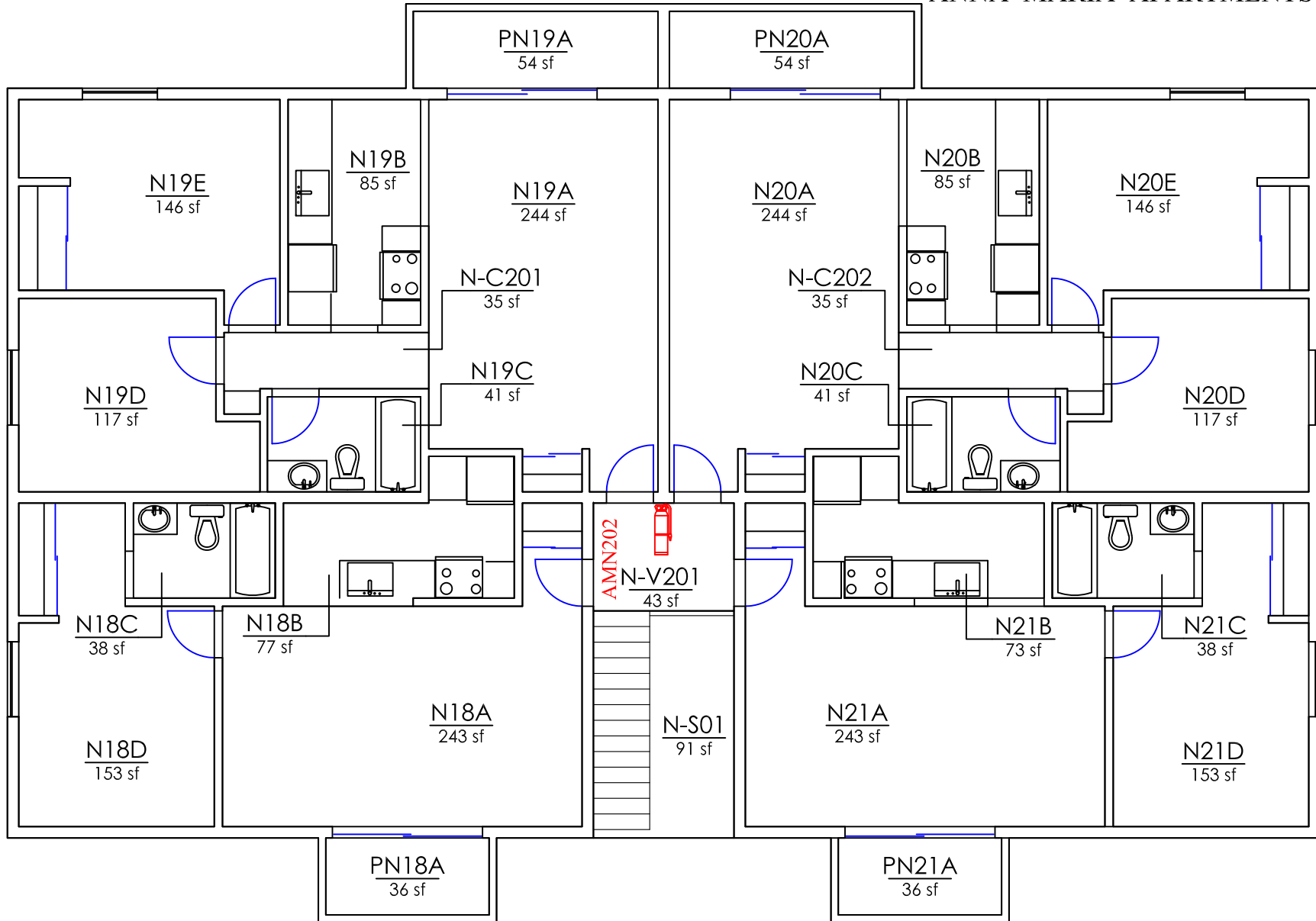

- FICM Code 210 Classroom
- FICM Code 110 Classroom

- = FIRE EXTINGUISHER
- = AED
- = FIRE DEP. CONNECTION
- = LOCK BOX
- = FIRE ALARM CONTROL PANEL
- = SPRINKLER HEADER
- = SPRINKLER RISER
- = Bottle Filler

DATE REVISED
09/30/2020

ADDRESS
922 Washington
Street

Square Feet
3009

BLDG NO
1216



(AMN) ANNA MARIA APPARTMENTS NORTH
BUILDING SECOND FLOOR

FLOOR
2

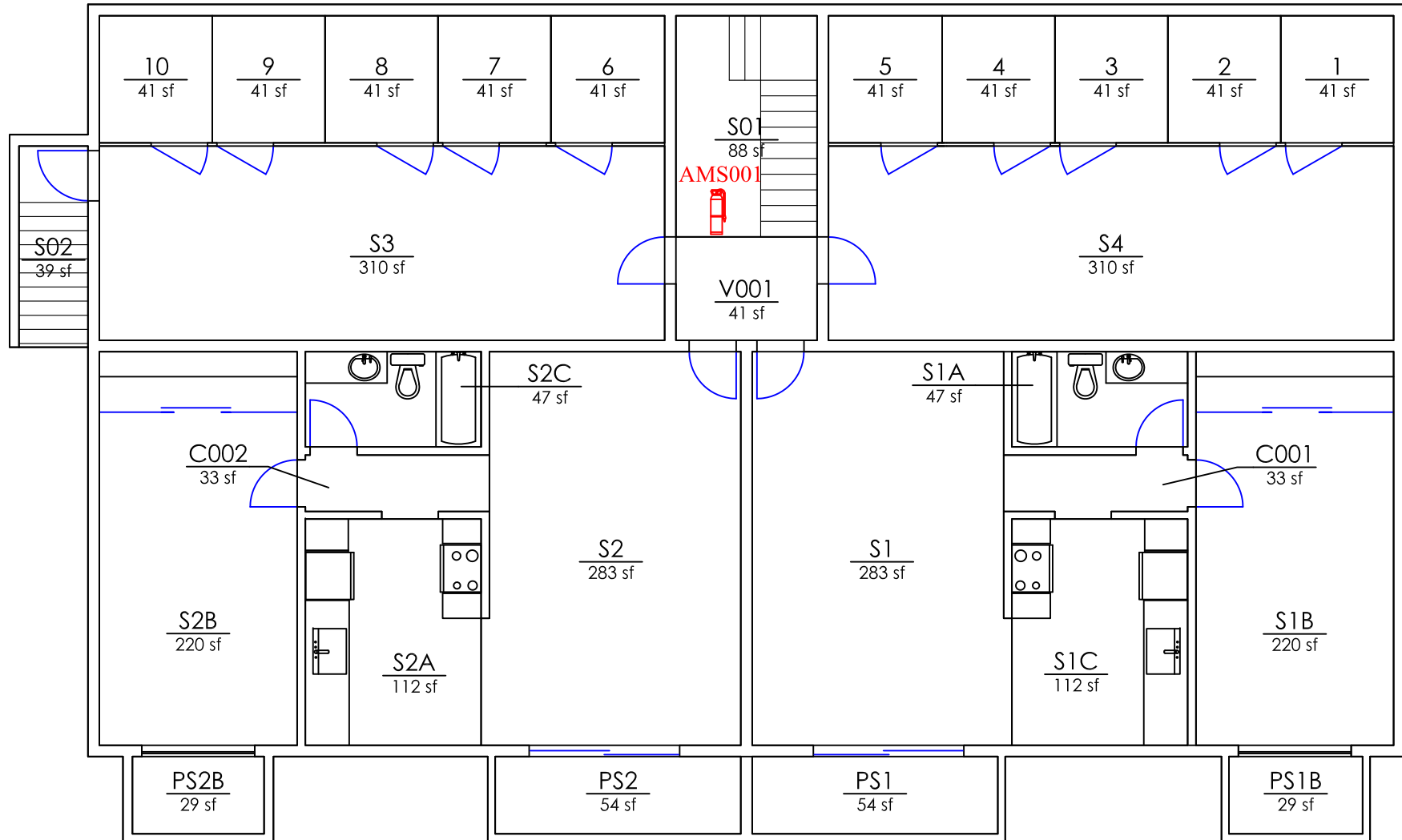

SOUTH BUILDING BASEMENT FLOOR
ANNA MARIA APARTMENTS



 FICM Code 210 Classroom
 FICM Code 110 Classroom

 = FIRE EXTINGUISHER  = AED  = FIRE DEP. CONNECTION  = LOCK BOX  = FIRE ALARM CONTROL PANEL  = SPRINKLER HEADER **R** = SPRINKLER RISER  = Bottle Filler

DATE REVISED
10/01/2020

ADDRESS
906 Washington
Street

Square Feet
3042

BLDG NO
1217

(AMS) ANNA MARIA APPARTMENTS
SOUTH BUILDING BASEMENT

FLOOR
0



SOUTH BUILDING FIRST FLOOR
ANNA MARIA APARTMENTS

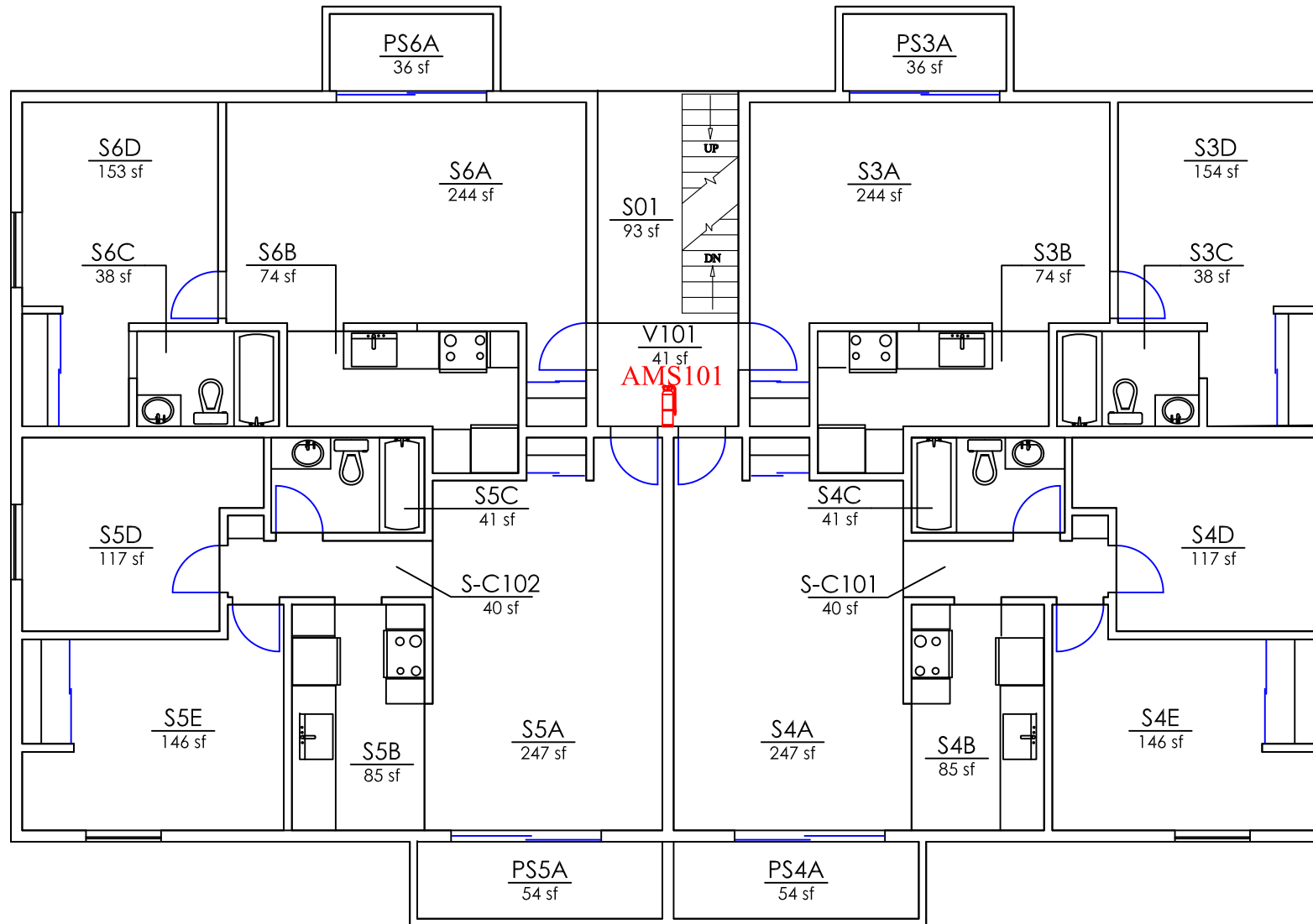

- FICM Code 210 Classroom
- FICM Code 110 Classroom

- = FIRE EXTINGUISHER
- = AED
- = FIRE DEP. CONNECTION
- = LOCK BOX
- = FIRE ALARM CONTROL PANEL
- = SPRINKLER HEADER
- = SPRINKLER RISER
- = Bottle Filler

DATE REVISED 10/01/2020	ADDRESS 906 Washington Street	Square Feet 3009	BLDG NO 1217	(AMS) ANNA MARIA APPARTMENTS SOUTH BUILDING FIRST FLOOR	FLOOR 1
----------------------------	----------------------------------	---------------------	-----------------	--	------------



SOUTH BUILDING SECOND FLOOR
ANNA MARIA APARTMENTS

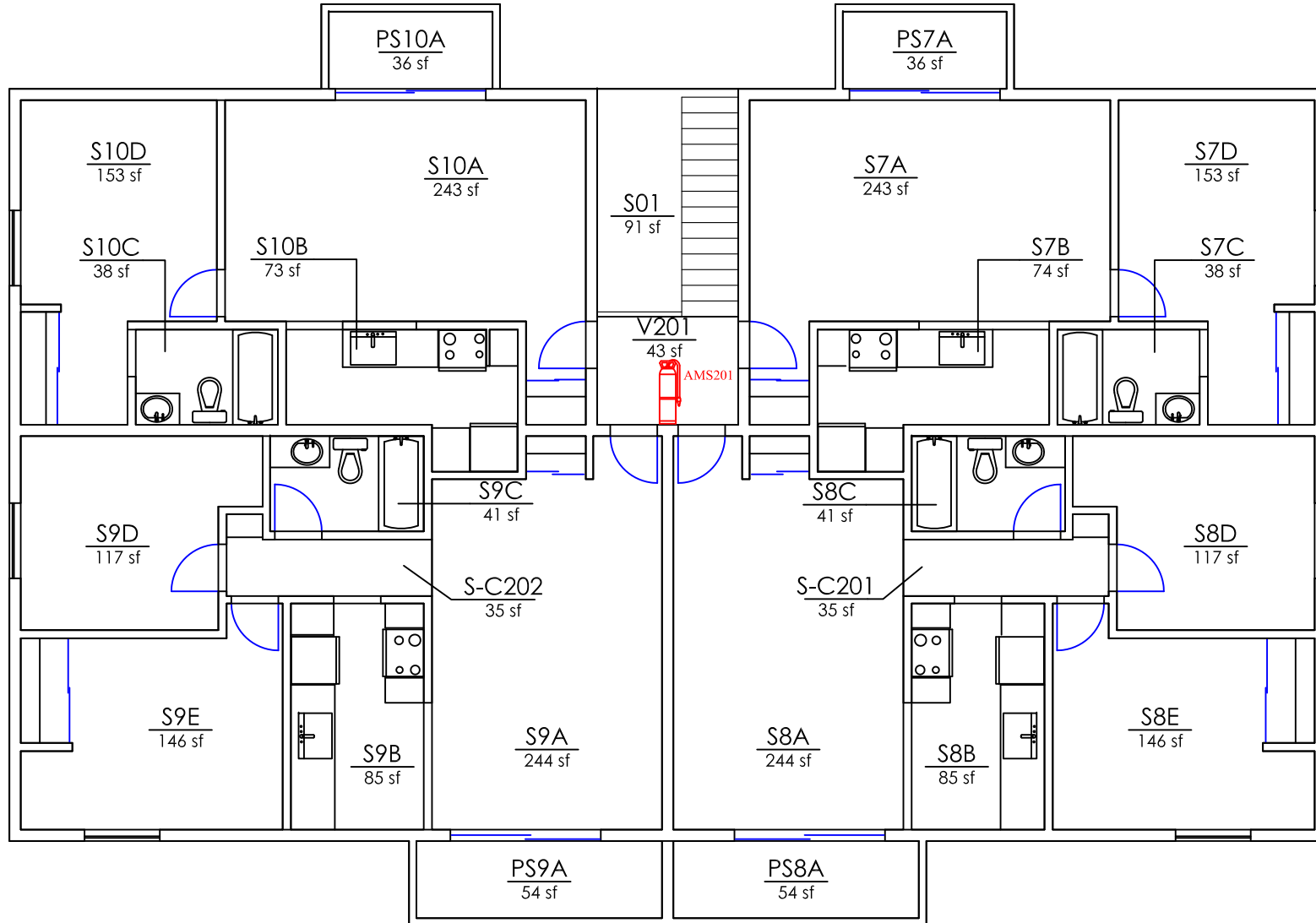



- FICM Code 210 Classroom
- FICM Code 110 Classroom

- = FIRE EXTINGUISHER
- = AED
- = FIRE DEP. CONNECTION
- = LOCK BOX
- = FIRE ALARM CONTROL PANEL
- = SPRINKLER HEADER
- = SPRINKLER RISER
- = Bottle Filler

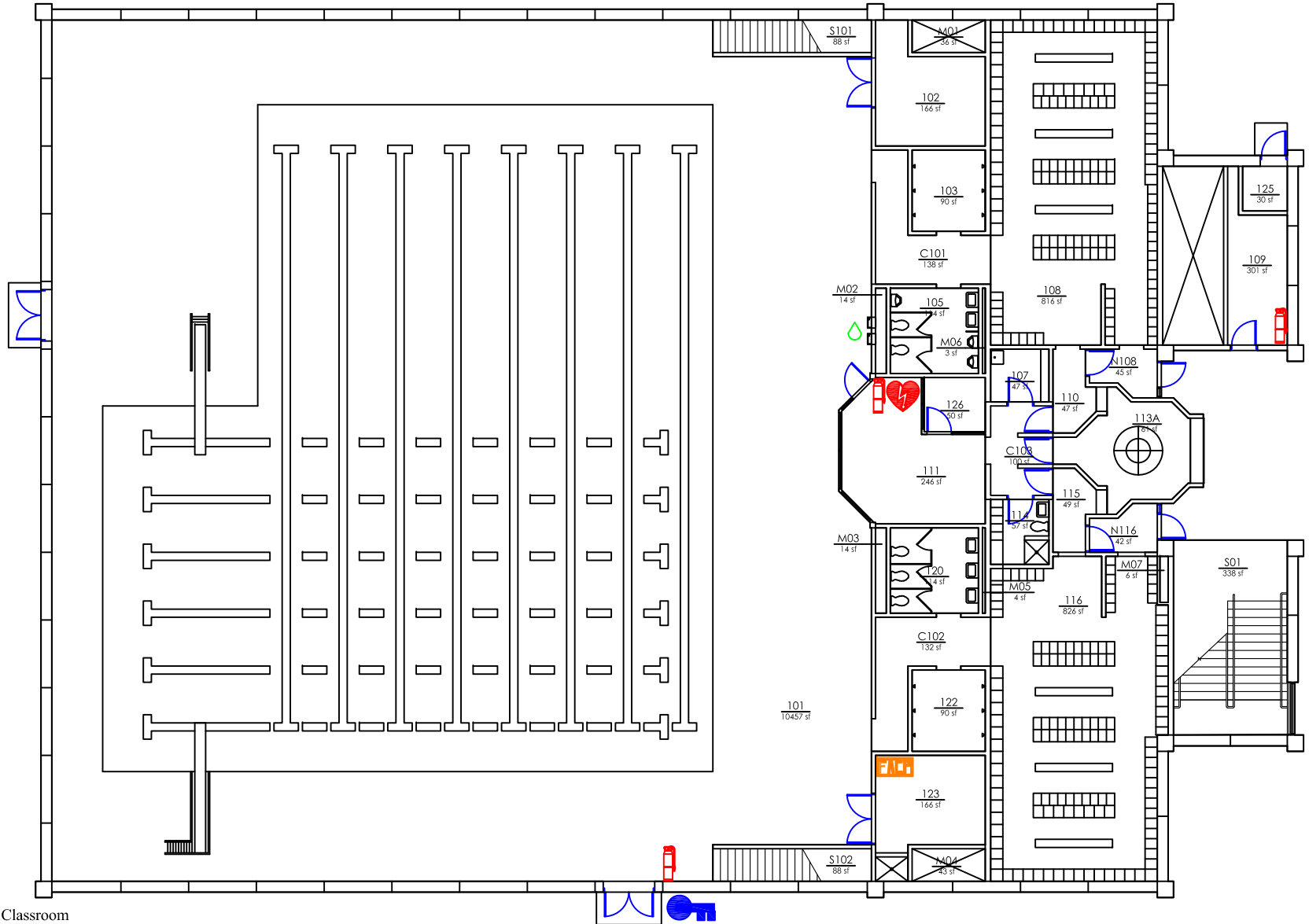
DATE REVISED 10/01/2020	ADDRESS 906 Washington Street	Square Feet 3009	BLDG NO 1217	(AMS) ANNA MARIA APPARTMENTS SOUTH BUILDING SECOND FLOOR	FLOOR 2
----------------------------	----------------------------------	---------------------	-----------------	---	------------



-  FICM Code 210 Classroom
-  FICM Code 110 Classroom

-  = FIRE EXTINGUISHER
-  = AED
-  = FIRE DEP. CONNECTION
-  = LOCK BOX
-  = FIRE ALARM CONTROL PANEL
-  = SPRINKLER HEADER
-  = SPRINKLER RISER
-  = Bottle Filler

DATE REVISED
10/01/2020

ADDRESS
1155 Playfield
LN

Square Feet
15915

BLDG NO
1340

(AQT) AQUATICS BUILDING
FIRST FLOOR

FLOOR
1

DRAWINGS ARE NOT TO SCALE



SECOND FLOOR
AQUATICS BUILDING

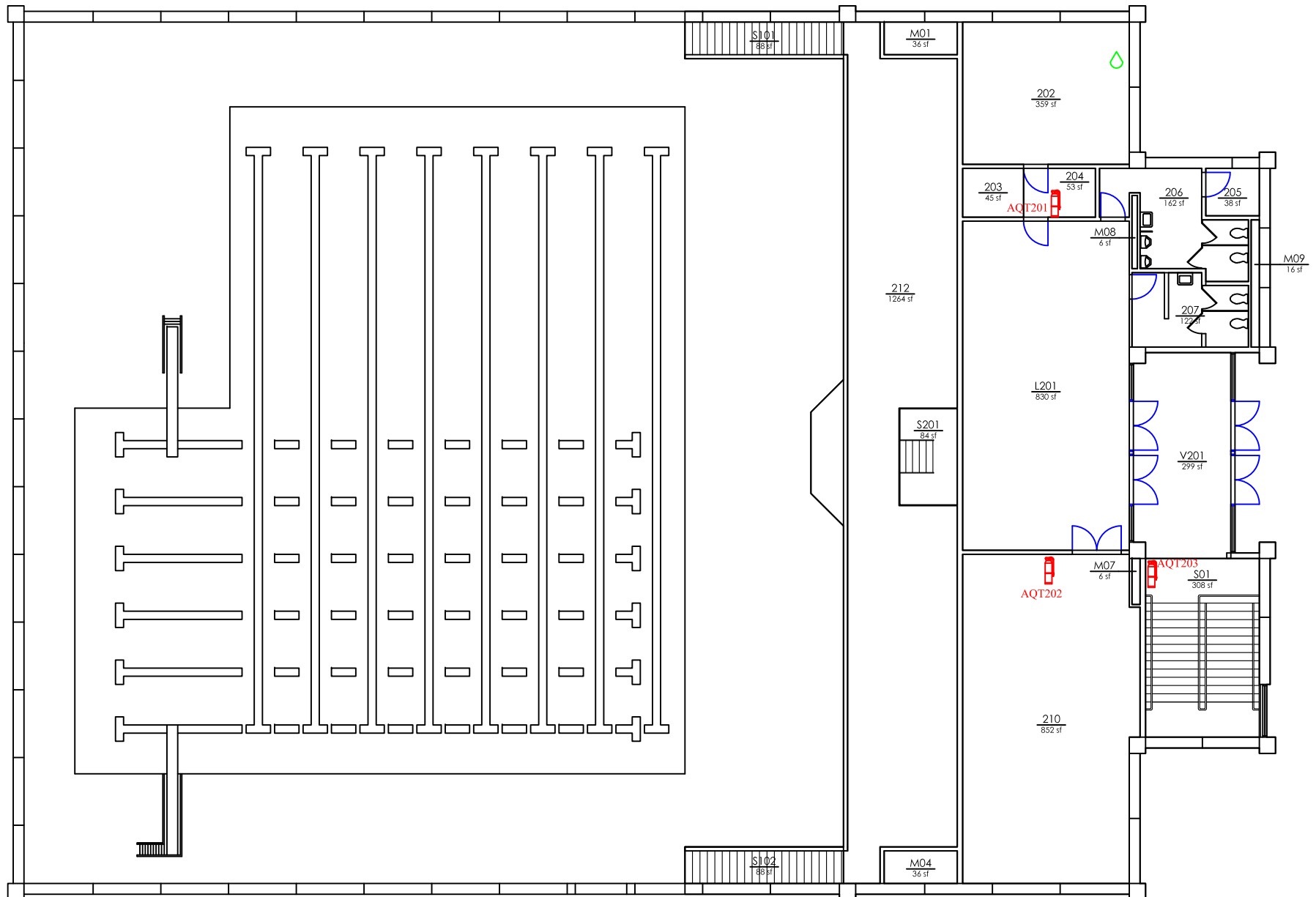

- FICM Code 210 Classroom
- FICM Code 110 Classroom

- = FIRE EXTINGUISHER
- = AED
- = FIRE DEP. CONNECTION
- = LOCK BOX
- = FIRE ALARM CONTROL PANEL
- = SPRINKLER HEADER
- = SPRINKLER RISER
- = Bottle Filler

DATE REVISED
10/01/2020

ADDRESS
1155 Playfield
LN



Square Feet
5322

BLDG NO
1340

(AQT) AQUATICS BUILDING
SECOND FLOOR

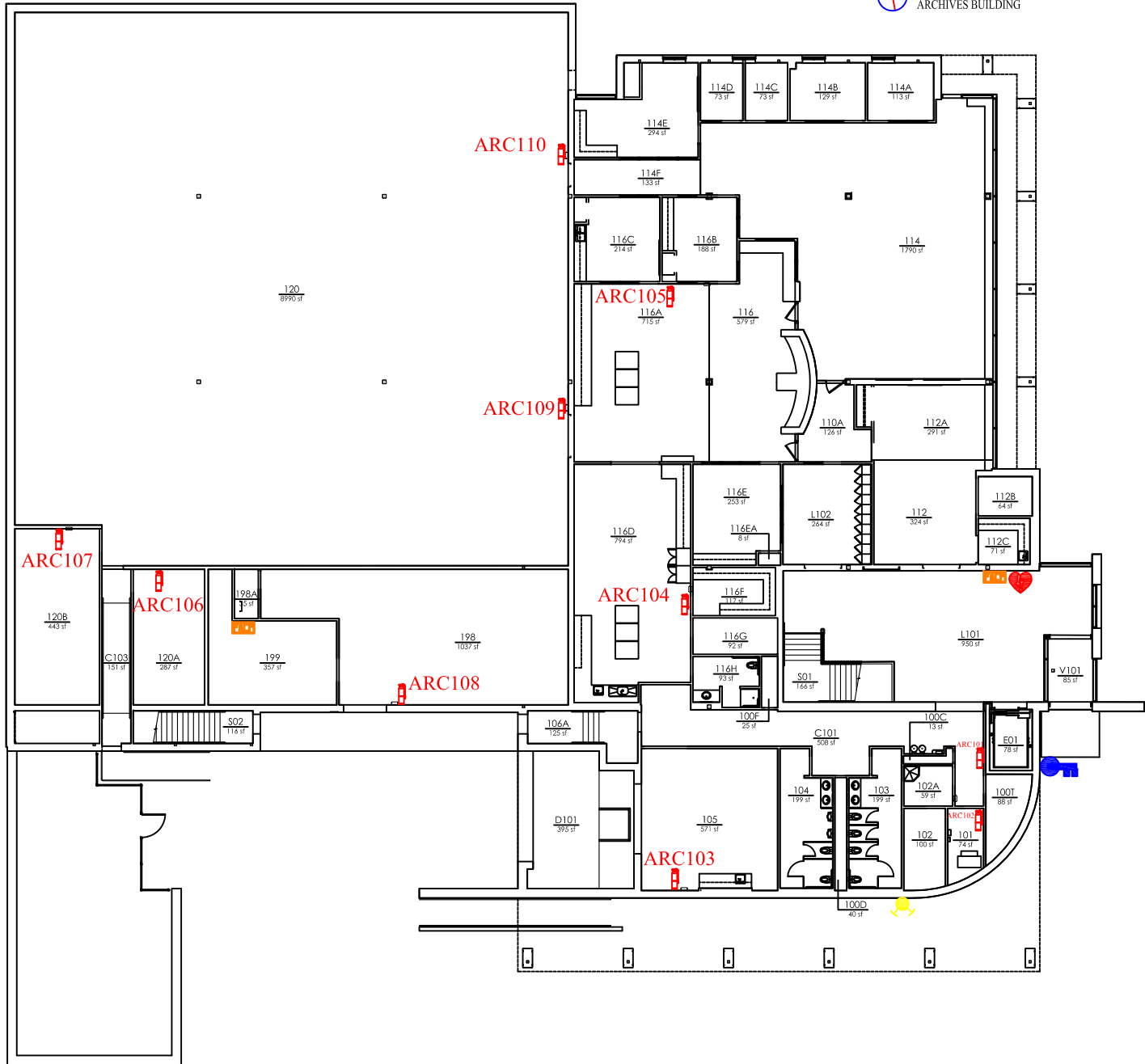
FLOOR
2



 FICM Code 210 Classroom
 FICM Code 110 Classroom

 = FIRE EXTINGUISHER  = AED  = FIRE DEP. CONNECTION  = LOCK BOX  = FIRE ALARM CONTROL PANEL  = SPRINKLER HEADER **R** = SPRINKLER RISER  = Bottle Filler

DATE REVISED
10/01/2020

ADDRESS
960 Washington
Street

Square Feet
23788

BLDG NO
1225

(ARC) WA STATE DIGITAL ARCHIVES
FIRST FLOOR

FLOOR
1



FICM Code 210 Classroom
 FICM Code 110 Classroom

= FIRE EXTINGUISHER = AED = FIRE DEP. CONNECTION = LOCK BOX = FIRE ALARM CONTROL PANEL = SPRINKLER HEADER **R** = SPRINKLER RISER = Bottle Filler

DATE REVISED
02/01/2022

ADDRESS
960 Washington Street

Square Feet
24952

BLDG NO
1225

(ARC) WA STATE DIGITAL ARCHIVES
SECOND FLOOR

FLOOR
2

DRAWINGS ARE NOT TO SCALE

FIRST FLOOR
ART BUILDING

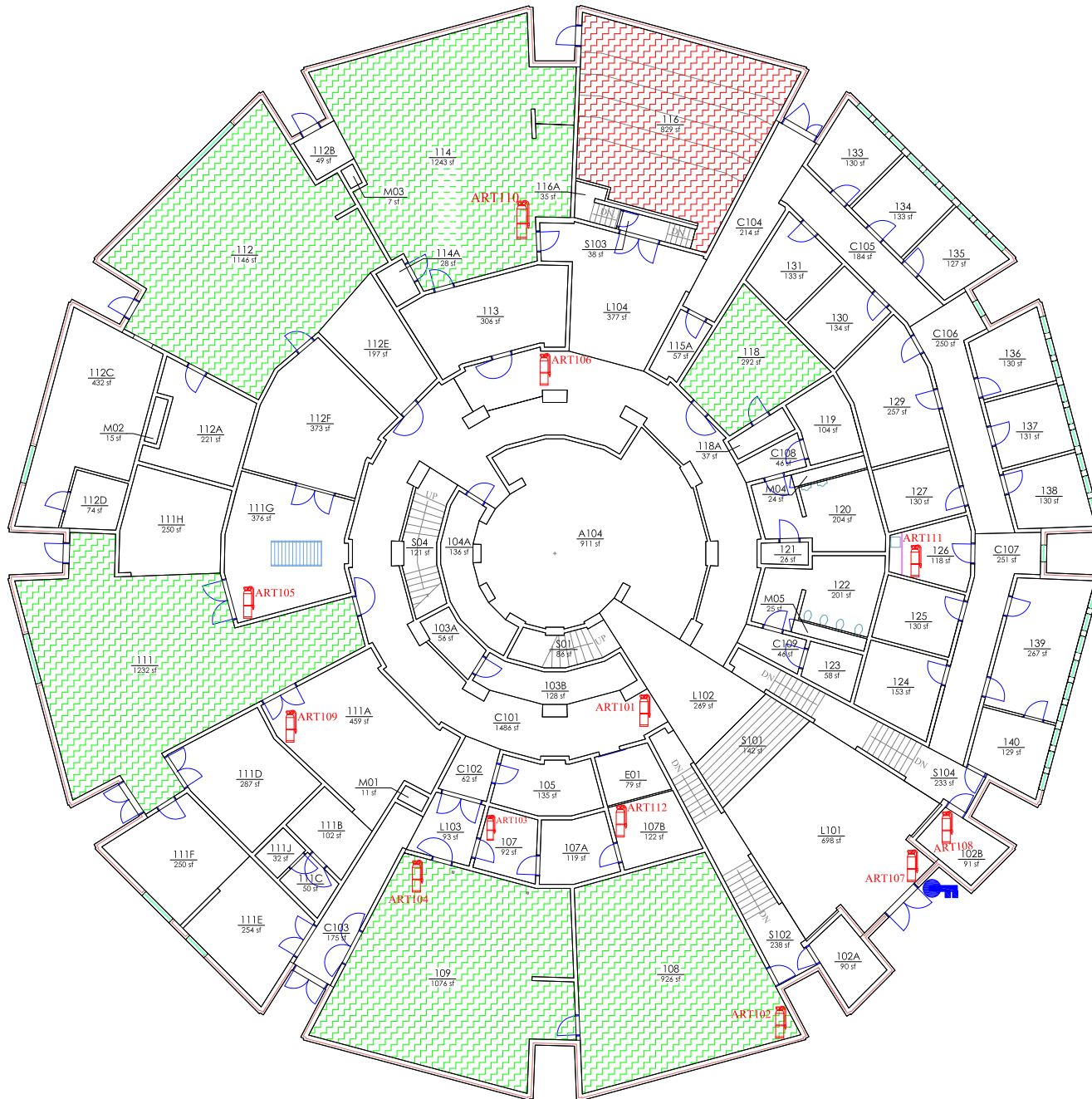

FICM Code 210 Classroom
 FICM Code 110 Classroom

= FIRE EXTINGUISHER
 = AED
 = FIRE DEP. CONNECTION
 = LOCK BOX
 = FIRE ALARM CONTROL PANEL
 = SPRINKLER HEADER
 R = SPRINKLER RISER
 = Bottle Filler

DATE REVISED
07/22/2020

ADDRESS
22 7th Street

Square Feet
22557

BLDG NO
1145



(ART) ART BUILDING
FIRST FLOOR

FLOOR
1

DRAWINGS ARE NOT TO SCALE

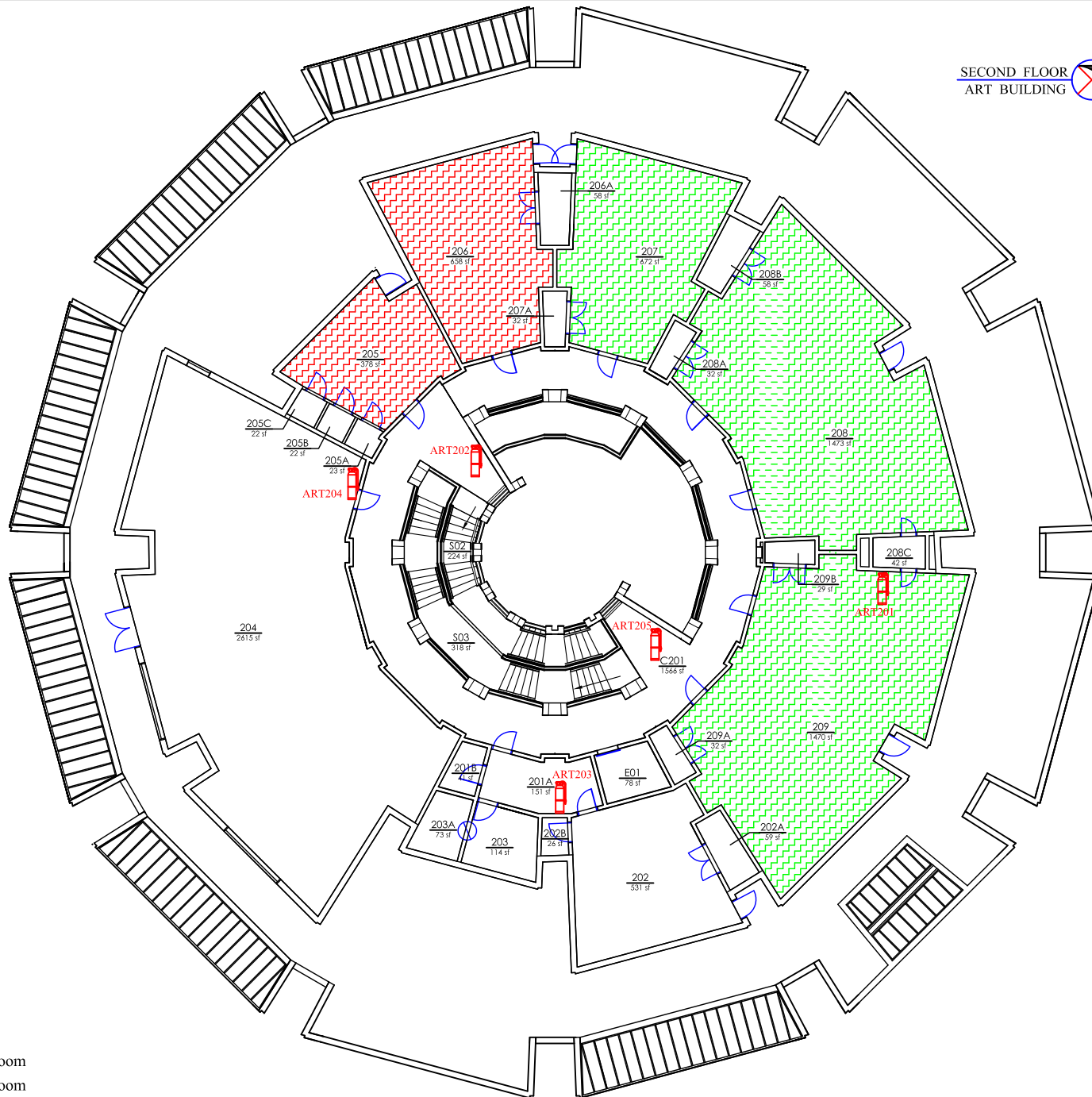
SECOND FLOOR
ART BUILDING



 FICM Code 210 Classroom
 FICM Code 110 Classroom

 = FIRE EXTINGUISHER  = AED  = FIRE DEP. CONNECTION  = LOCK BOX  = FIRE ALARM CONTROL PANEL  = SPRINKLER HEADER **R** = SPRINKLER RISER  = Bottle Filler

DATE REVISED
07/23/2020

ADDRESS
22 7th Street

Square Feet
11912



BLDG NO
1145

(ART) ART BUILDING
SECOND FLOOR

FLOOR
2

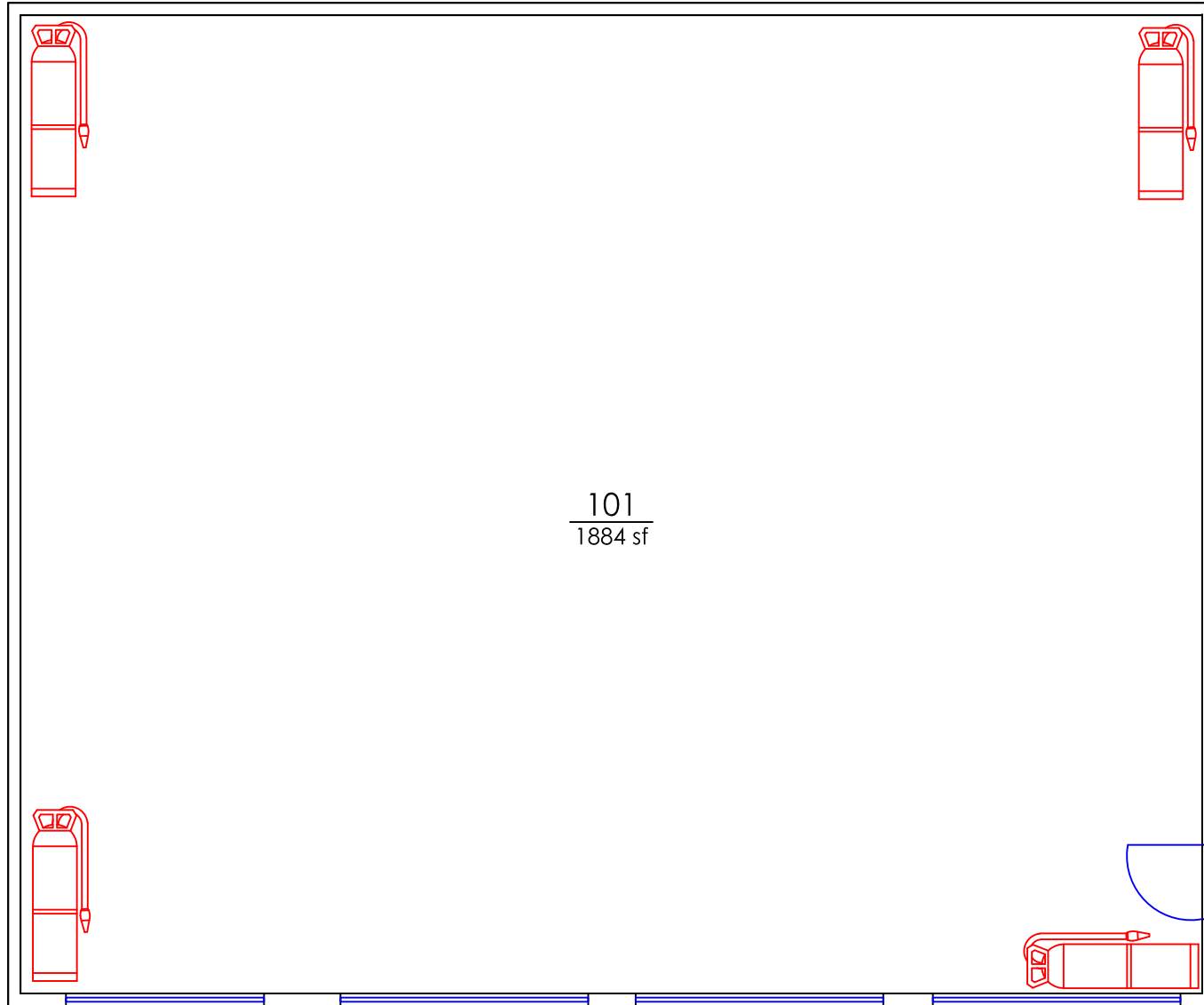
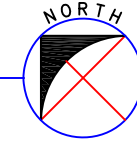
FLOOR PLAN BIOLOGY GARAGE



 FICM Code 210 Classroom
 FICM Code 110 Classroom

 = FIRE EXTINGUISHER  = AED  = FIRE DEP. CONNECTION  = LOCK BOX  = FIRE ALARM CONTROL PANEL  = SPRINKLER HEADER **R** = SPRINKLER RISER  = Bottle Filler

DATE REVISED
10/06/2020

ADDRESS
1320 Woodward
LN

Square Feet
1973



BLDG NO
1485

(BOG) BIOLOGY GARAGE FLOOR PLAN

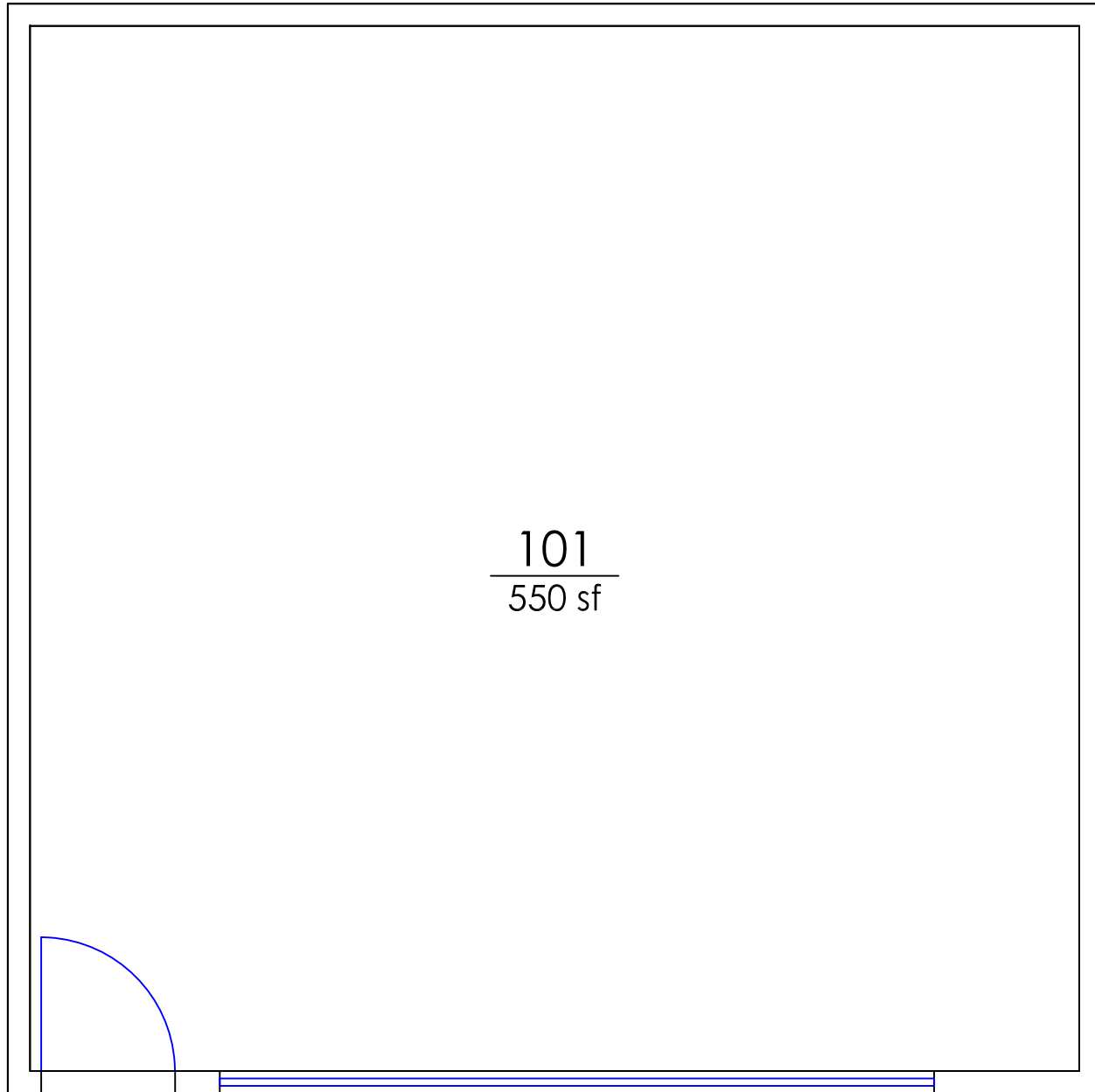
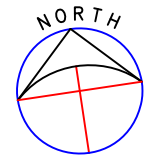
FLOOR
1



101
550 sf

 FICM Code 210 Classroom
 FICM Code 110 Classroom

 = FIRE EXTINGUISHER  = AED  = FIRE DEP. CONNECTION  = LOCK BOX  = FIRE ALARM CONTROL PANEL  = SPRINKLER HEADER **R** = SPRINKLER RISER  = Bottle Filler

DATE REVISED
10-07-2020

ADDRESS
1320 Woodward LN



Square Feet
598

BLDG NO
1490

(BOS) BIOLOGY STORAGE
FLOOR PLAN

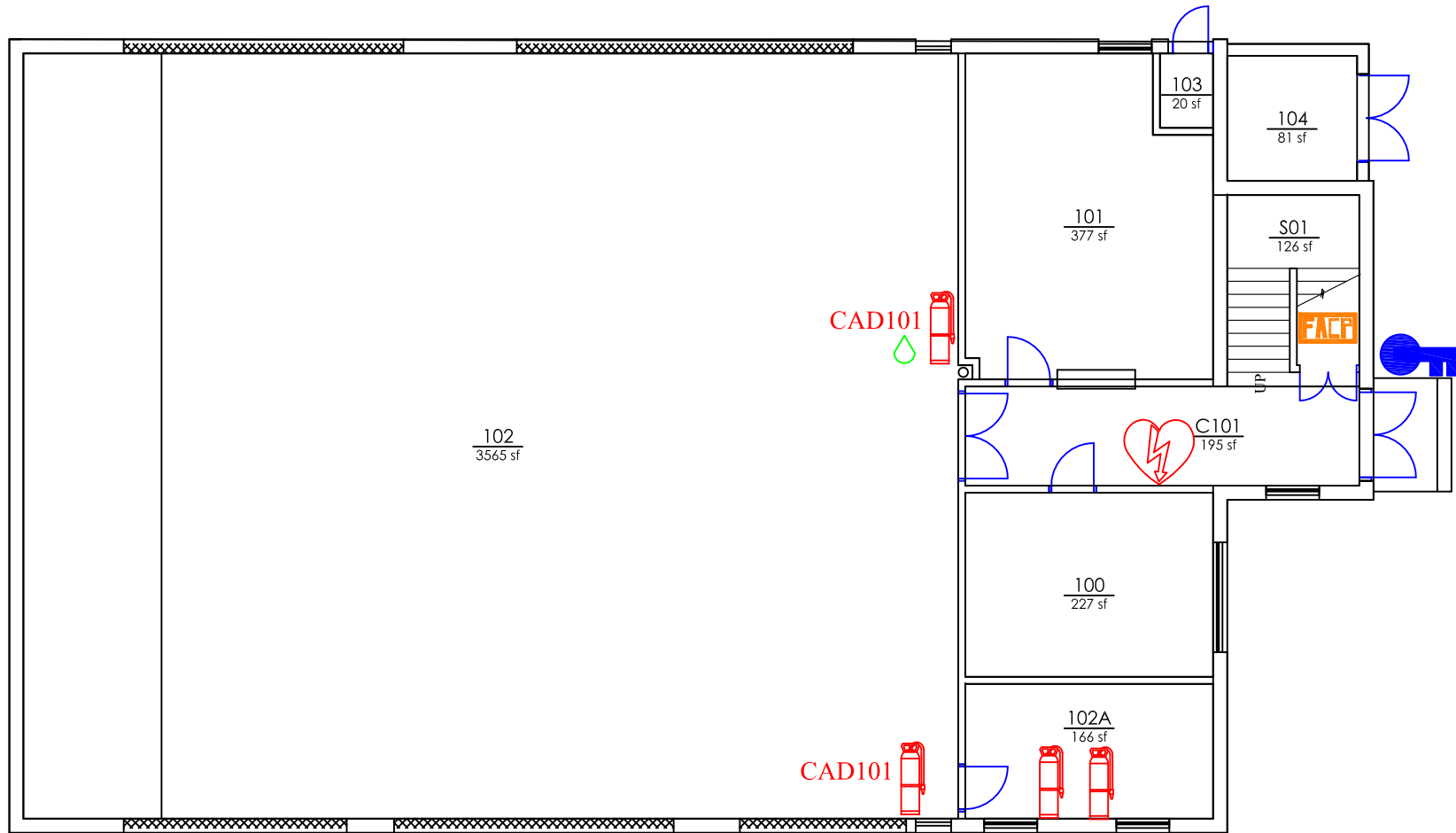
FLOOR
1



 FICM Code 210 Classroom
 FICM Code 110 Classroom

 = FIRE EXTINGUISHER  = AED  = FIRE DEP. CONNECTION  = LOCK BOX  = FIRE ALARM CONTROL PANEL  = SPRINKLER HEADER  = SPRINKLER RISER  = Bottle Filler

DATE REVISED 07/23/2020	ADDRESS 1035 Washington Street	Square Feet 5138	BLDG NO 1157	(CAD) CADET HALL FIRST FLOOR		FLOOR 1
----------------------------	-----------------------------------	---------------------	-----------------	---	--	------------

SECOND FLOOR CADET HALL

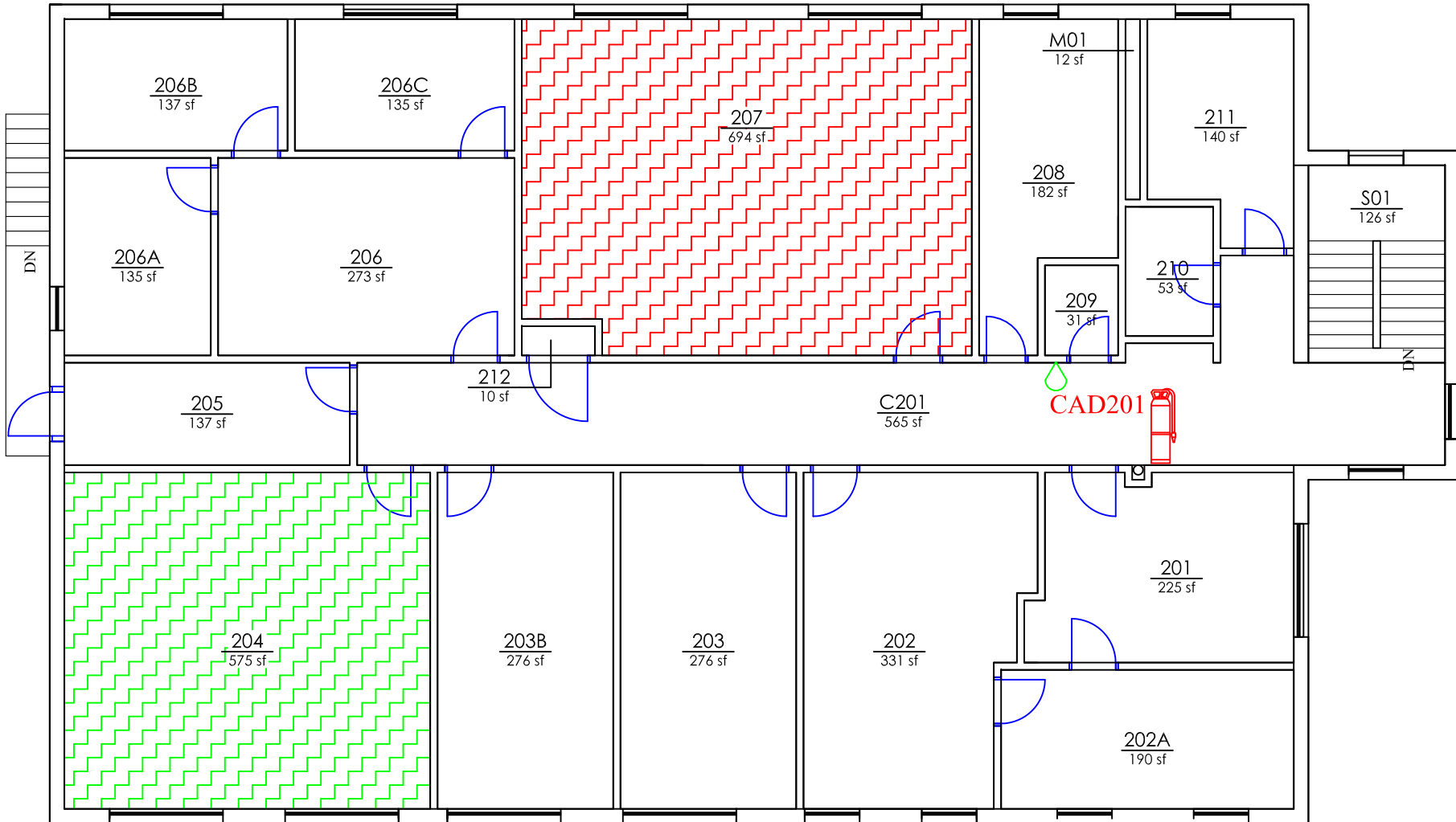

- FICM Code 210 Classroom
- FICM Code 110 Classroom

- = FIRE EXTINGUISHER
- = AED
- = FIRE DEP. CONNECTION
- = LOCK BOX
- = FIRE ALARM CONTROL PANEL
- = SPRINKLER HEADER
- = SPRINKLER RISER
- = Bottle Filler

DATE REVISED
07/24/2020

ADDRESS
1035 Washington
Street

Square Feet
5049

BLDG NO
1157

(CAD) CADET HALL
SECOND FLOOR

FLOOR
2

DRAWINGS ARE NOT TO SCALE



- FICM Code 210 Classroom
- FICM Code 110 Classroom

- = FIRE EXTINGUISHER
- = AED
- = FIRE DEP. CONNECTION
- = LOCK BOX
- = FIRE ALARM CONTROL PANEL
- = SPRINKLER HEADER
- R** = SPRINKLER RISER
- = Bottle Filler

DATE REVISED
09/10/2020

ADDRESS
1075 Washington
Street



Square Feet
23570

BLDG NO
1160

(CEB) COMPUTER AND ENGINEERING
BUILDING BASEMENT

FLOOR
0



 FICM Code 210 Classroom
 FICM Code 110 Classroom



 = FIRE EXTINGUISHER  = AED  = FIRE DEP. CONNECTION  = LOCK BOX  = FIRE ALARM CONTROL PANEL  = SPRINKLER HEADER **R** = SPRINKLER RISER  = Bottle Filler

DATE REVISED 02/01/2022	ADDRESS 1075 Washington Street	Square Feet 27588	BLDG NO 1160	(CEB) COMPUTER AND ENGINEERING BUILDING FIRST FLOOR	FLOOR 1
----------------------------	-----------------------------------	----------------------	-----------------	--	------------

DRAWINGS ARE NOT TO SCALE

SECOND FLOOR
COMPUTER ENGINEERING BUILDING



 FICM Code 210 Classroom
 FICM Code 110 Classroom

 = FIRE EXTINGUISHER  = AED  = FIRE DEP. CONNECTION  = LOCK BOX  = FIRE ALARM CONTROL PANEL  = SPRINKLER HEADER  = SPRINKLER RISER  = Bottle Filler

DATE REVISED
11/8/2021

ADDRESS
1475 Washington
Street

Square Feet
24931

BLDG NO
1160

(CEB) COMPUTER AND ENGINEERING BUILDING
SECOND FLOOR

FLOOR
2

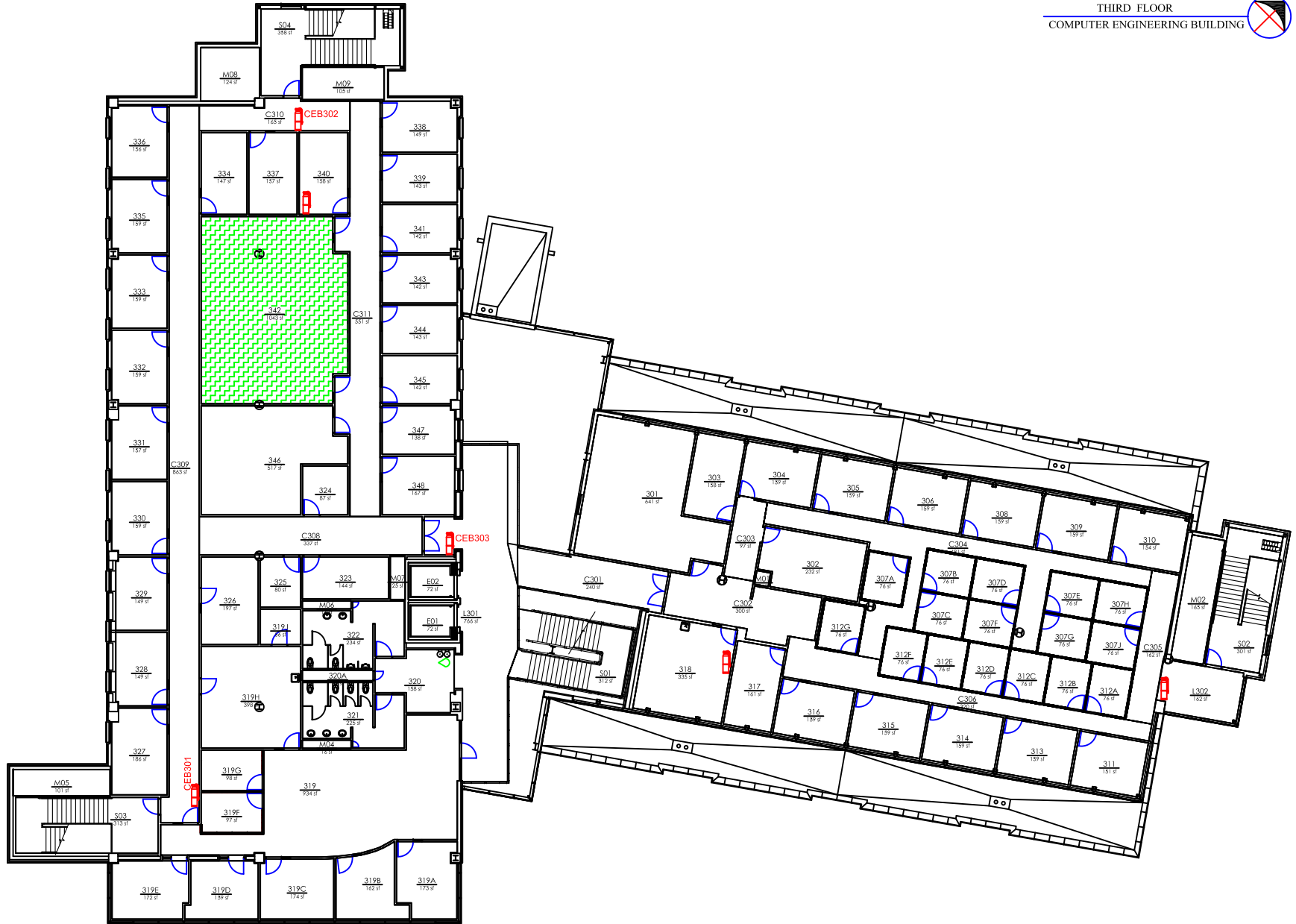

- FICM Code 210 Classroom
- FICM Code 110 Classroom



- = FIRE EXTINGUISHER
- = AED
- = FIRE DEP. CONNECTION
- = LOCK BOX
- = FIRE ALARM CONTROL PANEL
- = SPRINKLER HEADER
- = SPRINKLER RISER
- = Bottle Filler

DATE REVISED 09/14/2020	ADDRESS 1075 Washington Street	Square Feet 22387	BLDG NO 1160	(CEB) COMPUTER AND ENGINEERING BUILDING THIRD FLOOR	FLOOR 3
----------------------------	-----------------------------------	----------------------	-----------------	--	------------

DRAWINGS ARE NOT TO SCALE

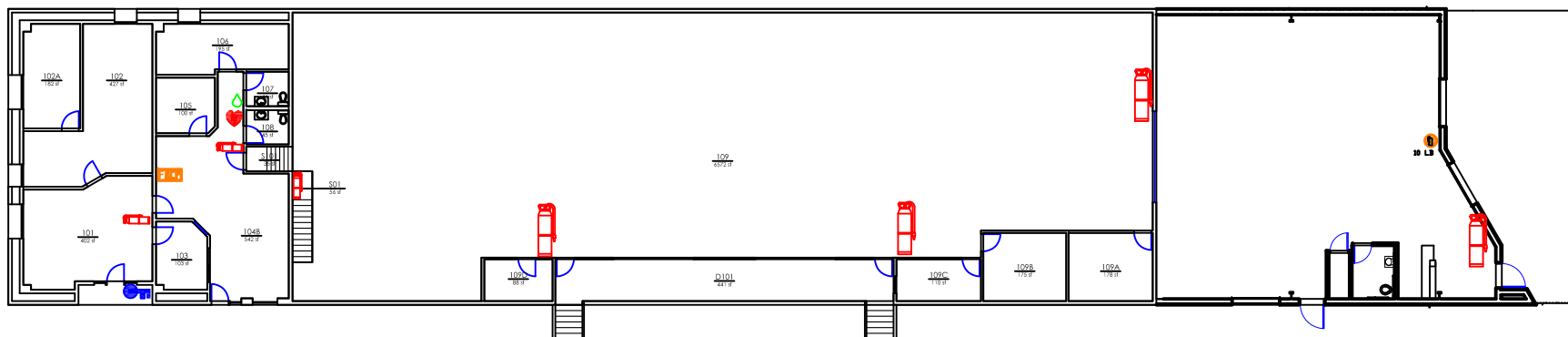
FIRST FLOOR
CENTRAL STORES



-  FICM Code 210 Classroom
-  FICM Code 110 Classroom



-  = FIRE EXTINGUISHER
-  = AED
-  = FIRE DEP. CONNECTION
-  = LOCK BOX
-  = FIRE ALARM CONTROL PANEL
-  = SPRINKLER HEADER
-  = SPRINKLER RISER
-  = Bottle Filler

DATE REVISED	ADDRESS	Square Feet	BLDG NO	(CES) CENTRAL SERVICES FIRST FLOOR	FLOOR 1
10/08/2020	1320 Woodward LN	13355	1405		

DRAWINGS ARE NOT TO SCALE

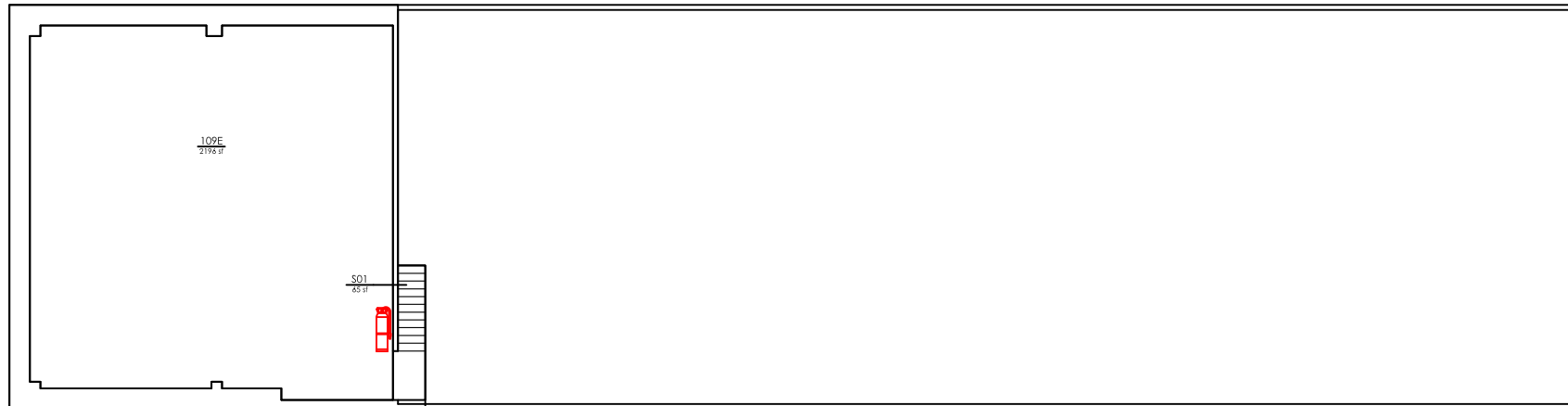
 MEZZANINE
CENTRAL STORES





 FICM Code 210 Classroom
 FICM Code 110 Classroom

 = FIRE EXTINGUISHER  = AED  = FIRE DEP. CONNECTION  = LOCK BOX  = FIRE ALARM CONTROL PANEL  = SPRINKLER HEADER **R** = SPRINKLER RISER  = Bottle Filler

DATE REVISED 10/08/2020	ADDRESS 1320 Woodward LN	Square Feet	BLDG NO 1405	(CES) CENTRAL SERVICES MEZZANINE	FLOOR 2
----------------------------	-----------------------------	-------------	-----------------	-------------------------------------	------------

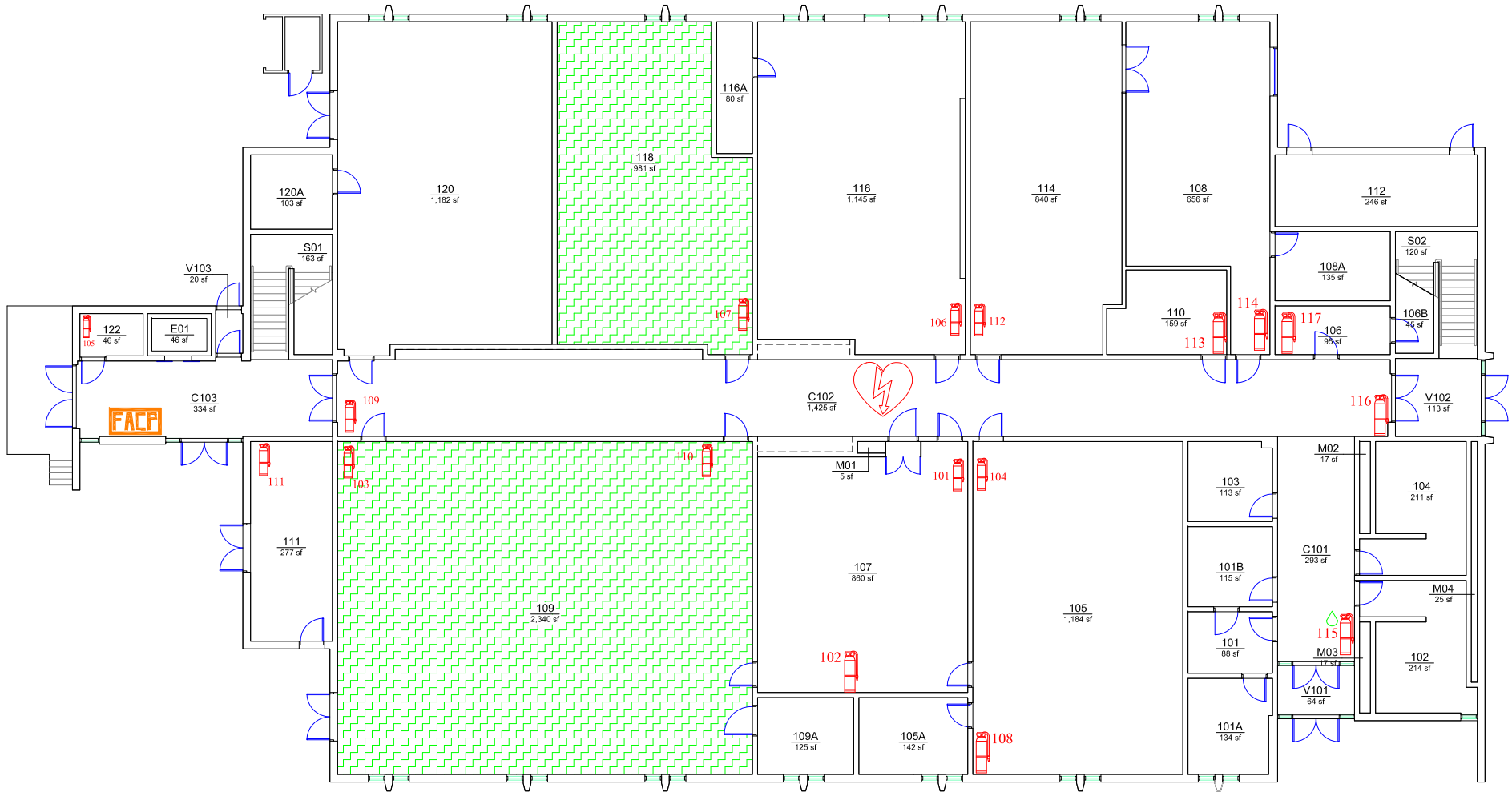
DRAWINGS ARE NOT TO SCALE



 FICM Code 210 Classroom
 FICM Code 110 Classroom



 = FIRE EXTINGUISHER  = AED  = FIRE DEP. CONNECTION  = LOCK BOX  = FIRE ALARM CONTROL PANEL  = SPRINKLER HEADER **R** = SPRINKLER RISER  = Bottle Filler

DATE REVISED 02/01/2022	ADDRESS 1121 Washington Street	Square Feet 15512	BLDG NO 1163	(CHN) CHENEY HALL FIRST FLOOR	FLOOR 1
----------------------------	-----------------------------------	----------------------	-----------------	----------------------------------	------------

DRAWINGS ARE NOT TO SCALE

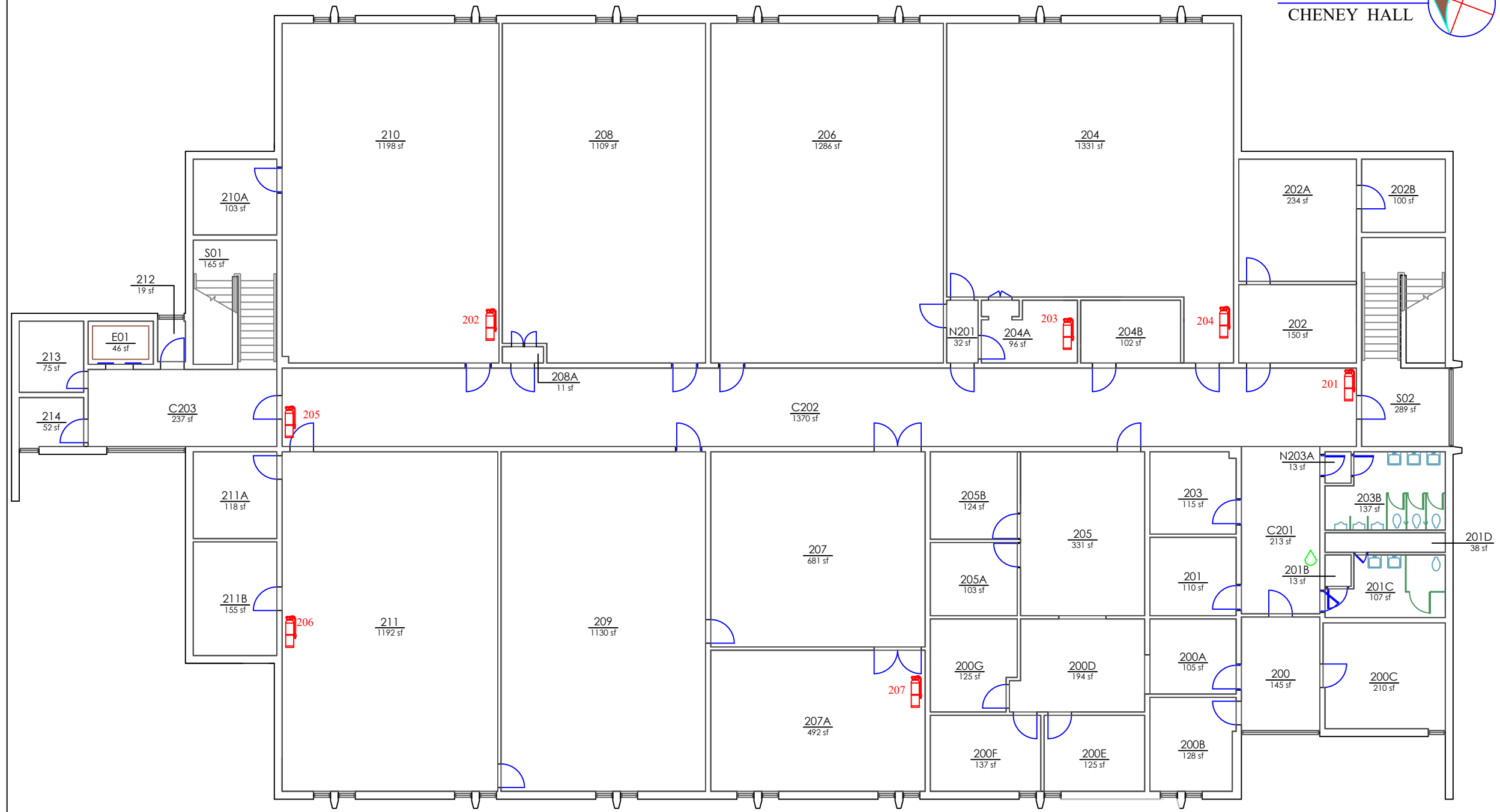
SECOND FLOOR
CHENEY HALL

 FICM Code 210 Classroom
 FICM Code 110 Classroom



 = FIRE EXTINGUISHER  = AED  = FIRE DEP. CONNECTION  = LOCK BOX  = FIRE ALARM CONTROL PANEL  = SPRINKLER HEADER **R** = SPRINKLER RISER  = Bottle Filler

DATE REVISED 02/01/2022	ADDRESS 1121 Washington Street	Square Feet 15506	BLDG NO 1163	(CHN) CHENEY HALL SECOND FLOOR	FLOOR 2
----------------------------	-----------------------------------	----------------------	-----------------	-----------------------------------	------------

DRAWINGS ARE NOT TO SCALE

FIRST FLOOR
COMMUNICATIONS BUILDING





 FICM Code 210 Classroom
 FICM Code 110 Classroom



 = FIRE EXTINGUISHER  = AED  = FIRE DEP. CONNECTION  = LOCK BOX  = FIRE ALARM CONTROL PANEL  = SPRINKLER HEADER  = SPRINKLER RISER  = Bottle Filler

DATE REVISED 07/27/2020	ADDRESS 110 Media LN	Square Feet 9619	BLDG NO 1142	(CMC) COMMUNICATIONS BUILDING FIRST FLOOR	FLOOR 1
----------------------------	-------------------------	---------------------	-----------------	--	------------

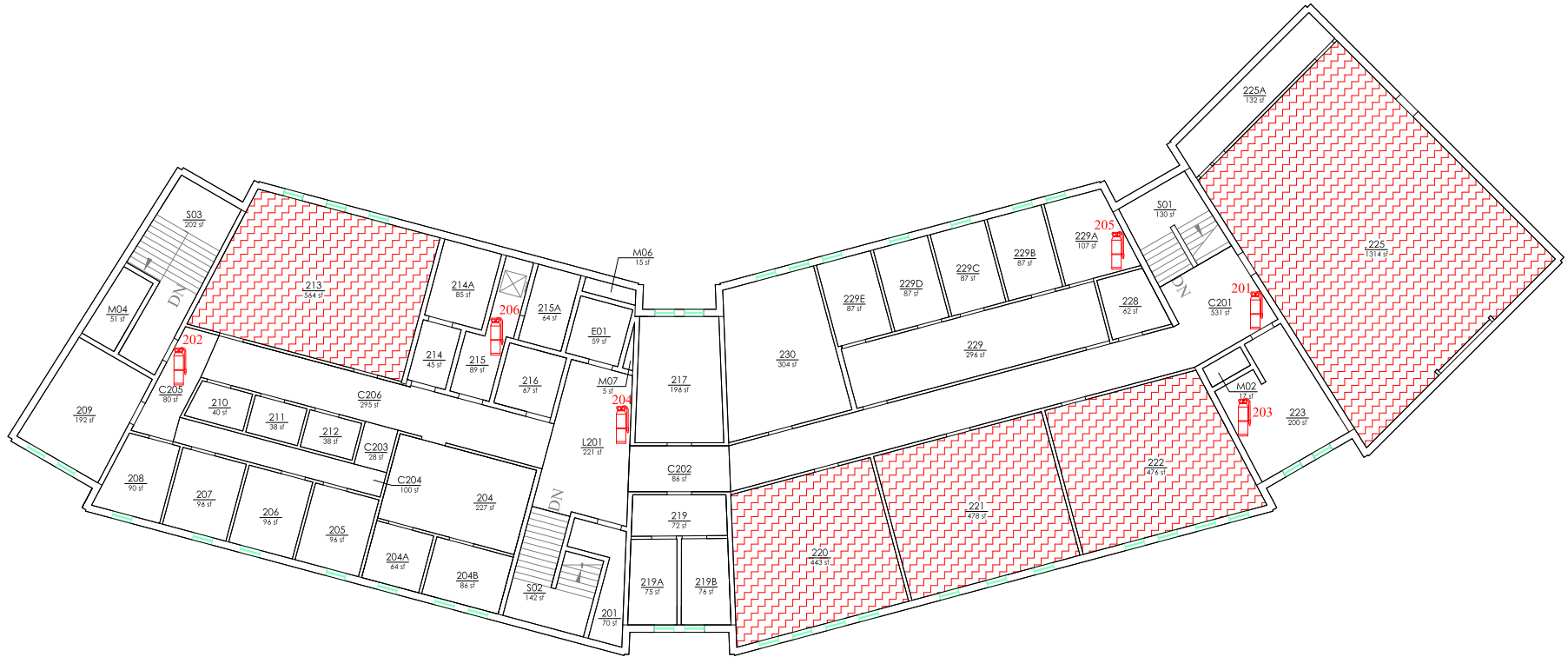
DRAWINGS ARE NOT TO SCALE

SECOND FLOOR
COMMUNICATIONS BUILDING



 FICM Code 210 Classroom
 FICM Code 110 Classroom

 = FIRE EXTINGUISHER  = AED  = FIRE DEP. CONNECTION  = LOCK BOX  = FIRE ALARM CONTROL PANEL  = SPRINKLER HEADER **R** = SPRINKLER RISER  = Bottle Filler

DATE REVISED 02/01/2022	ADDRESS 110 Media LN	Square Feet 9670	BLDG NO 1142	(CMC) COMMUNICATIONS BUILDING SECOND FLOOR	FLOOR 2
----------------------------	-------------------------	---------------------	-----------------	---	------------

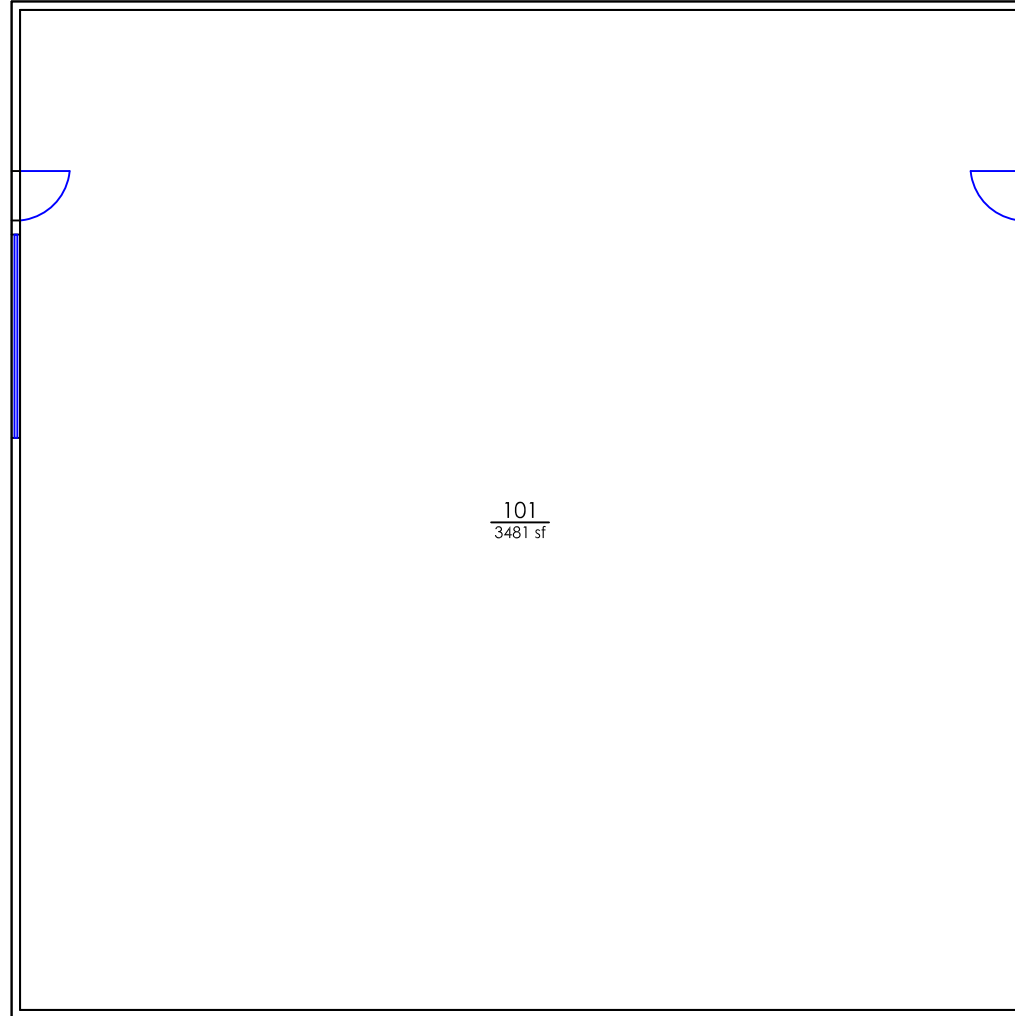

FLOOR PLAN
CARPENTER STORAGE

 FICM Code 210 Classroom
 FICM Code 110 Classroom

 = FIRE EXTINGUISHER  = AED  = FIRE DEP. CONNECTION  = LOCK BOX  = FIRE ALARM CONTROL PANEL  = SPRINKLER HEADER **R** = SPRINKLER RISER  = Bottle Filler

DATE REVISED
10/08/2020

ADDRESS
1320 Woodward LN

Square Feet
3600



BLDG NO
1414

(CSB) CARPENTER STORAGE
FLOOR PLAN

FLOOR
1

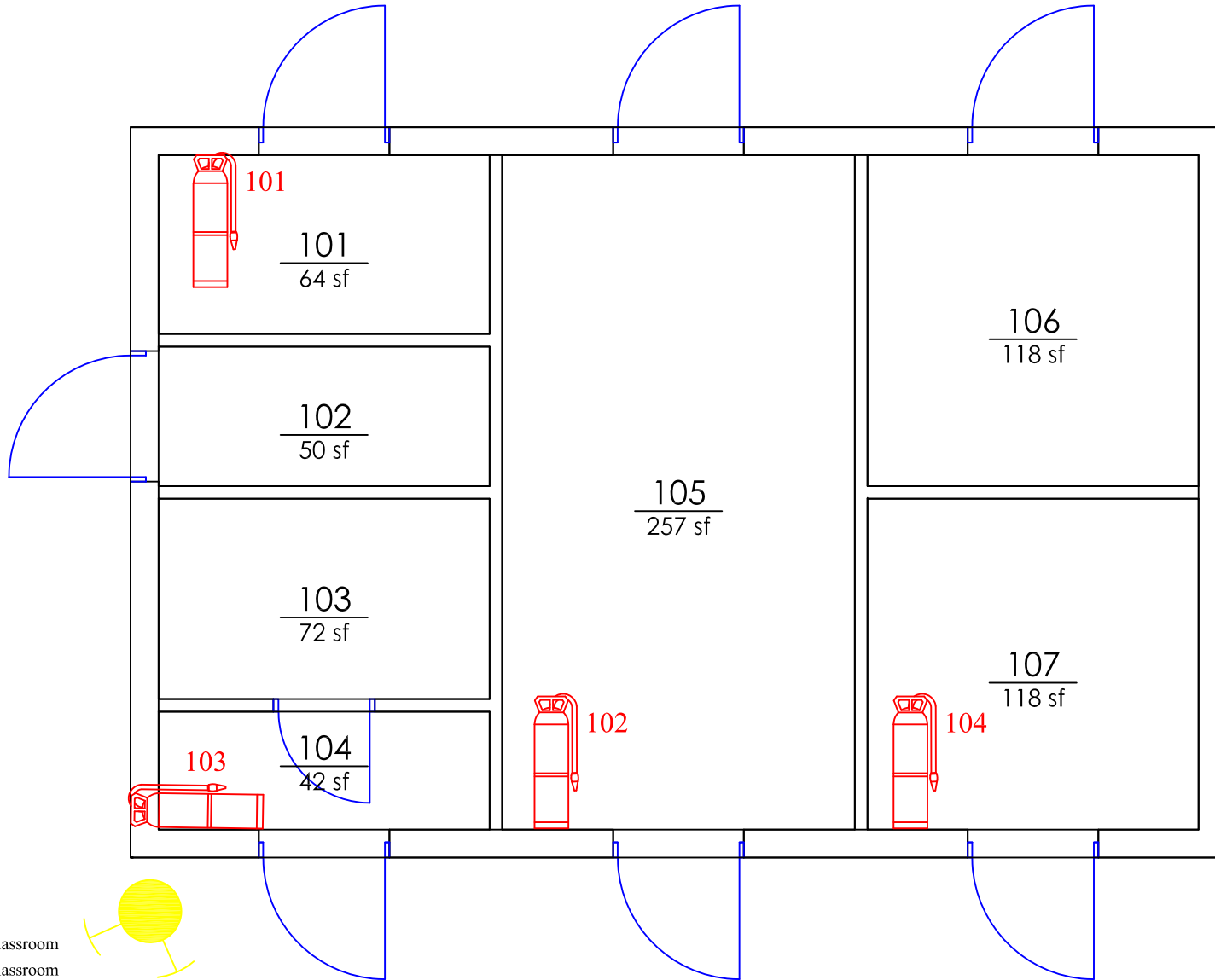
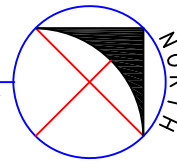
FLOOR PLAN CHEMICAL STORAGE FACILITY



 FICM Code 210 Classroom
 FICM Code 110 Classroom

 = FIRE EXTINGUISHER
  = AED
  = FIRE DEP. CONNECTION
  = LOCK BOX
  = FIRE ALARM CONTROL PANEL
  = SPRINKLER HEADER
 R = SPRINKLER RISER
  = Bottle Filler

DATE REVISED
10/09/2020

ADDRESS
1320 Woodward LN

Square Feet
864



BLDG NO
1410

(CST) CHEMICAL STORAGE FACILITY
FLOOR PLAN

FLOOR
1

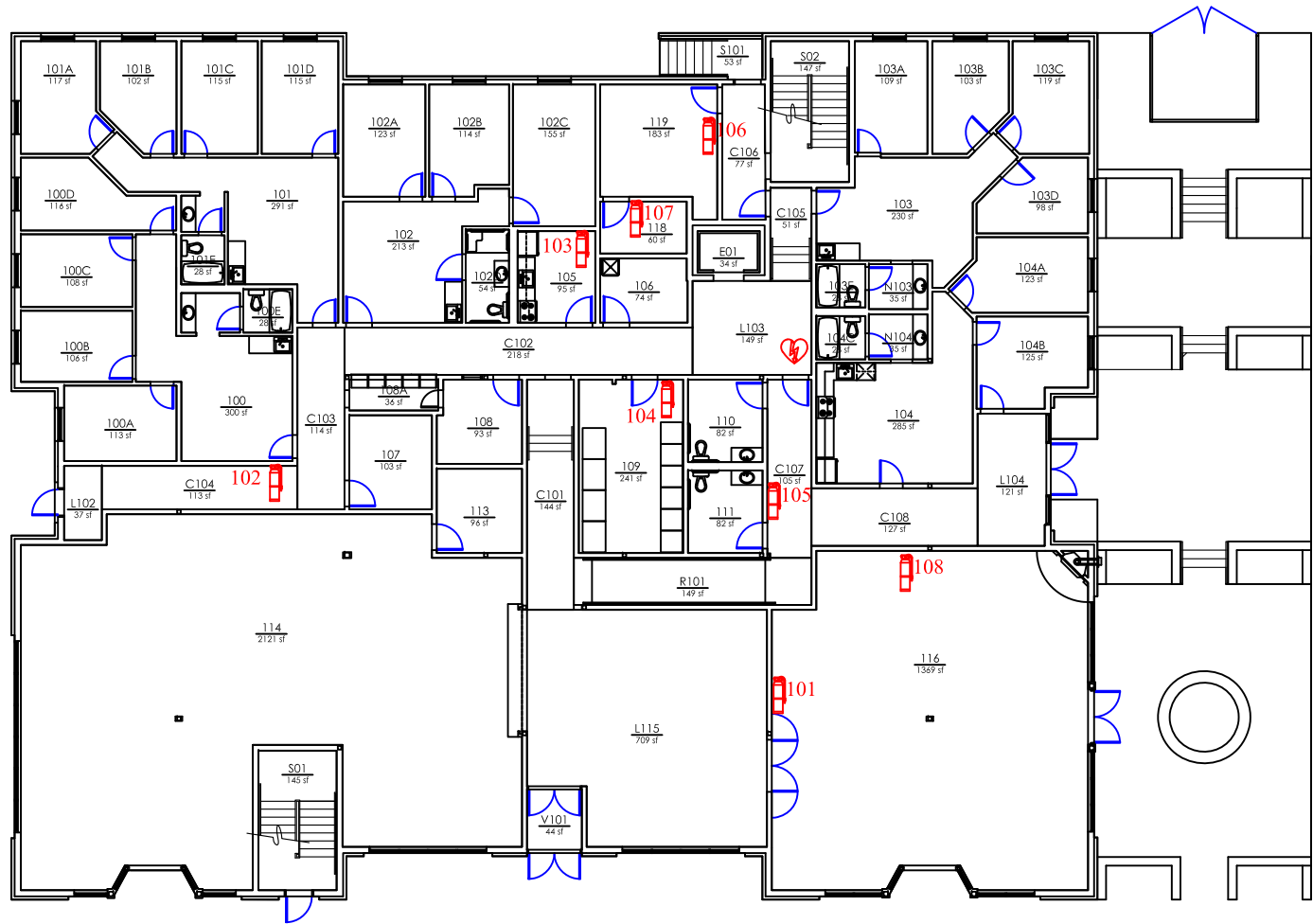
FIRST FLOOR
DOROTHY BREWSTER HALL

 FICM Code 210 Classroom
 FICM Code 110 Classroom

 = FIRE EXTINGUISHER  = AED  = FIRE DEP. CONNECTION  = LOCK BOX  = FIRE ALARM CONTROL PANEL  = SPRINKLER HEADER **R** = SPRINKLER RISER  = Bottle Filler

DATE REVISED
10/09/2020

ADDRESS
404 2nd Street

Square Feet
11842



BLDG NO
1605

(DBH) DOROTHY BREWSTER HALL
FIRST FLOOR

FLOOR
1

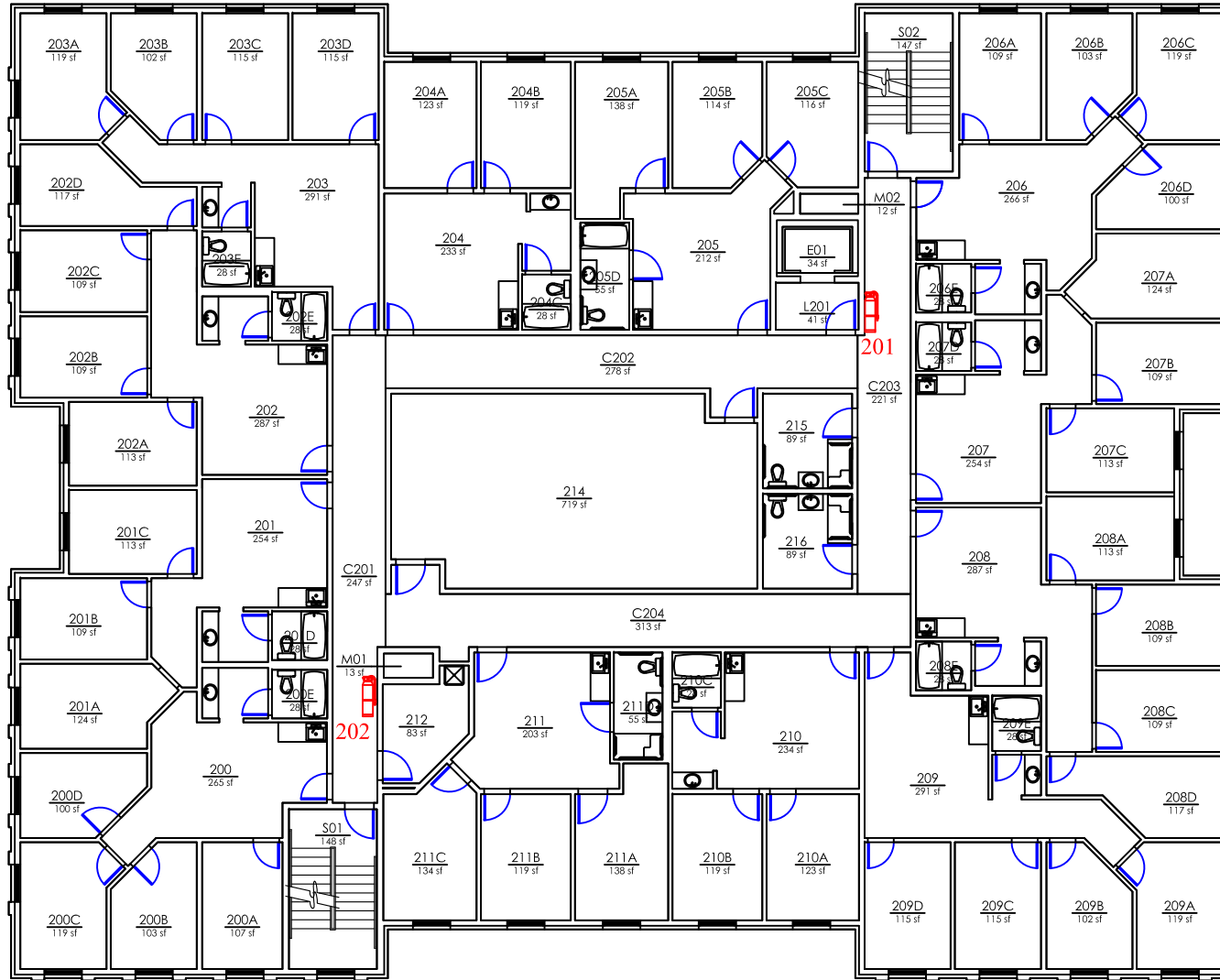
SECOND FLOOR
DOROTHY BREWSTER HALL



 FICM Code 210 Classroom
 FICM Code 110 Classroom

 = FIRE EXTINGUISHER  = AED  = FIRE DEP. CONNECTION  = LOCK BOX  = FIRE ALARM CONTROL PANEL  = SPRINKLER HEADER **R** = SPRINKLER RISER  = Bottle Filler

DATE REVISED
10/09/2020

ADDRESS
404 2nd Street

Square Feet
11903

BLDG NO
1605

(DBH) DOROTHY BREWSTER HALL
SECOND FLOOR

FLOOR
2

THIRD FLOOR
DOROTHY BREWSTER HALL

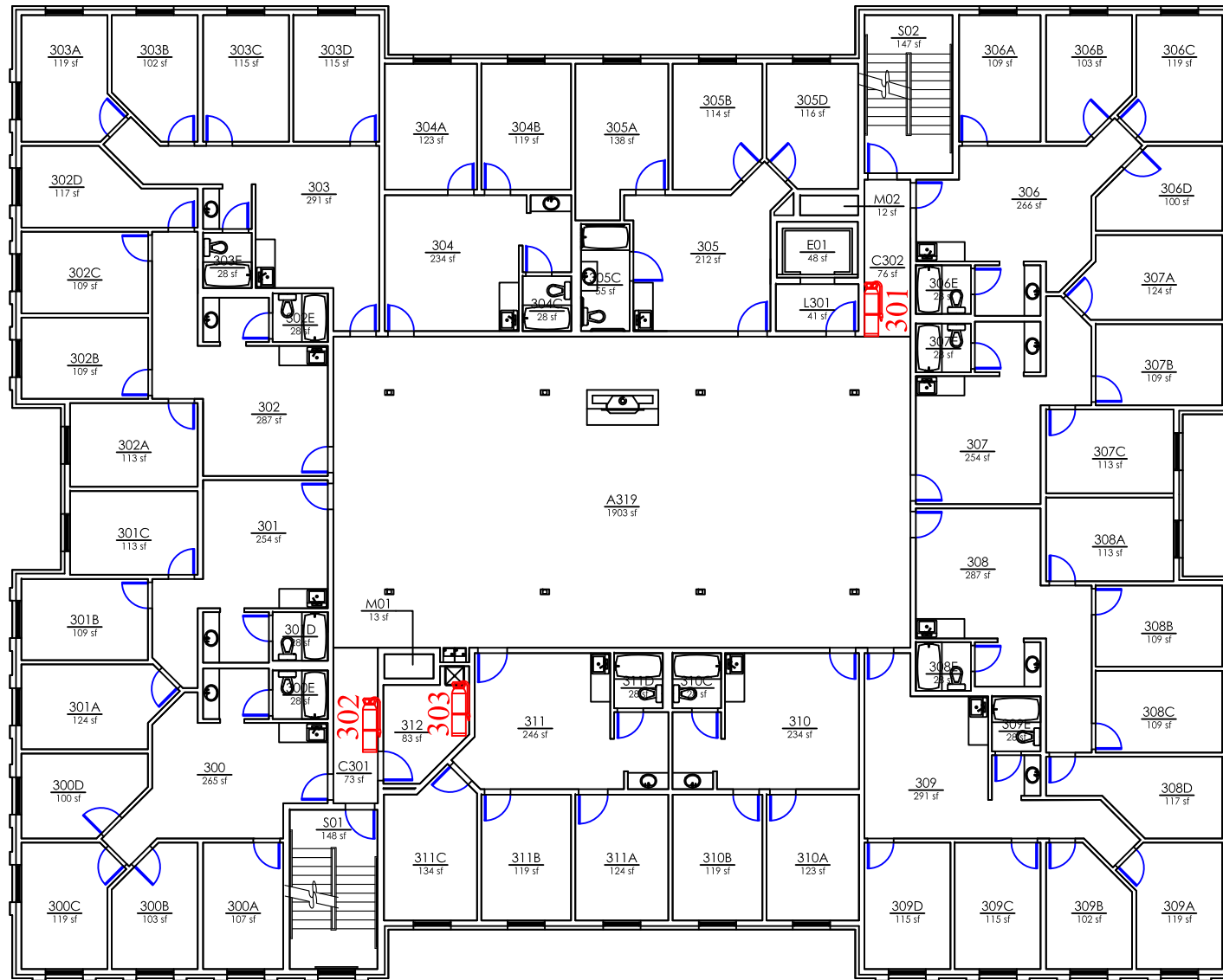

FICM Code 210 Classroom
 FICM Code 110 Classroom

= FIRE EXTINGUISHER = AED = FIRE DEP. CONNECTION = LOCK BOX = FIRE ALARM CONTROL PANEL = SPRINKLER HEADER **R** = SPRINKLER RISER = Bottle Filler

DATE REVISED 10/09/2020	ADDRESS 404 2nd Street	Square Feet 11903	BLDG NO 1605	(DBH) DOROTHY BREWSTER HALL FIRST FLOOR	FLOOR 3
----------------------------	---------------------------	----------------------	-----------------	--	------------

FOURTH FLOOR
DOROTHY BREWSTER HALL

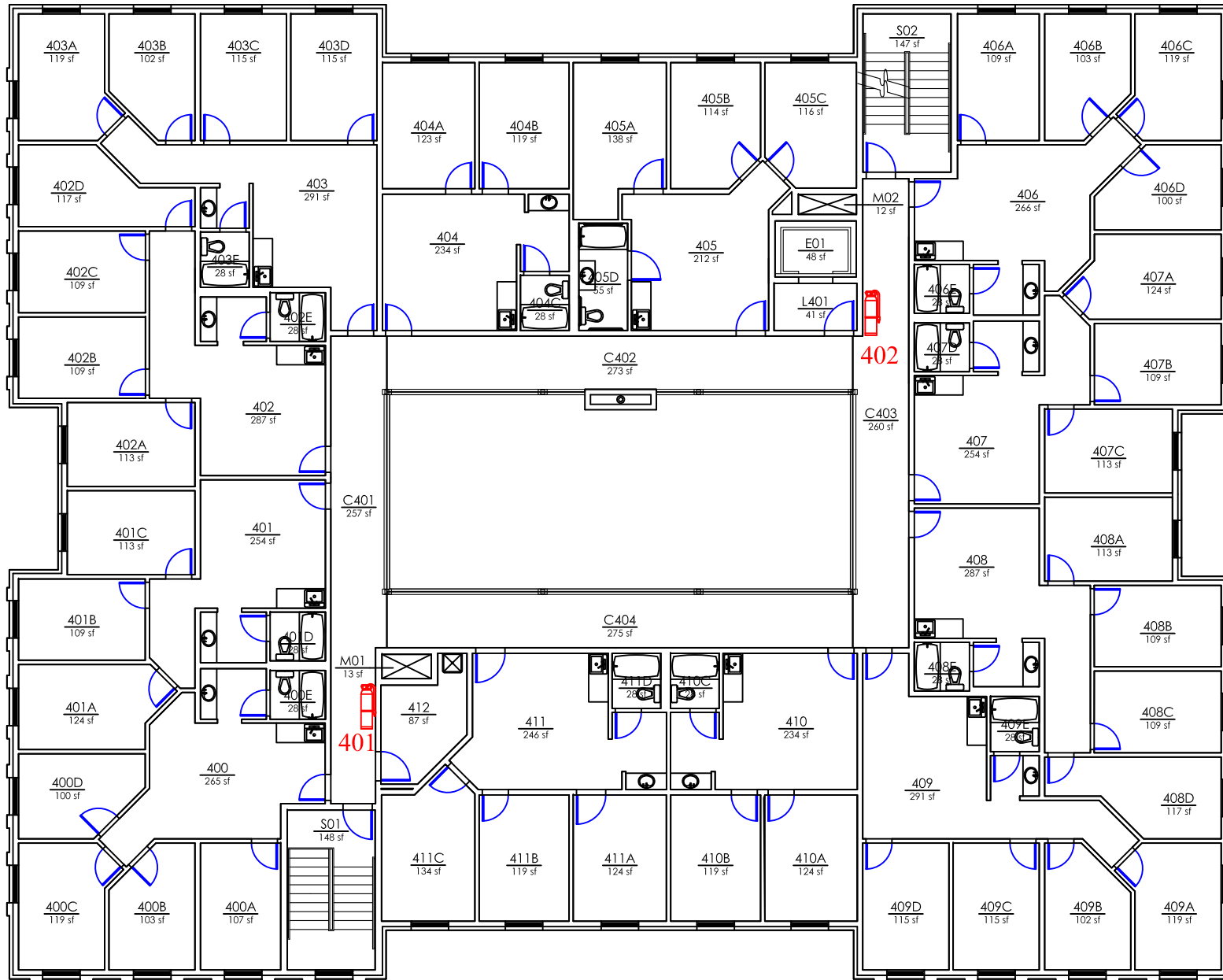

FICM Code 210 Classroom
 FICM Code 110 Classroom

= FIRE EXTINGUISHER = AED = FIRE DEP. CONNECTION = LOCK BOX = FIRE ALARM CONTROL PANEL = SPRINKLER HEADER **R** = SPRINKLER RISER = Bottle Filler

DATE REVISED
10/09/2020

ADDRESS
404 2nd Street

Square Feet
10971

BLDG NO
1605



(DBH) DOROTHY BREWSTER HALL
FOURTH FLOOR

FLOOR
4

DRAWINGS ARE NOT TO SCALE

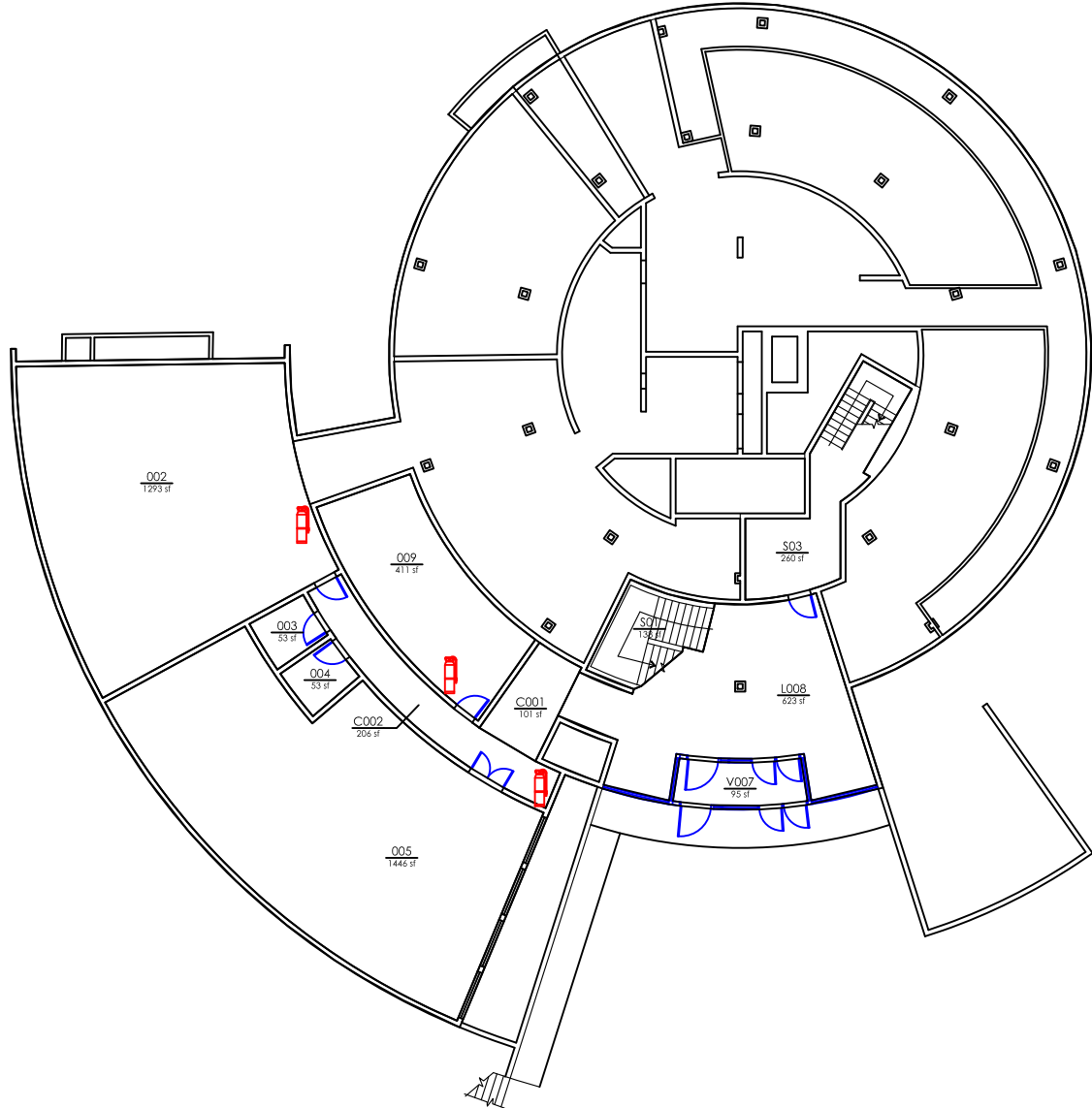
ENTRY FLOOR PLAN
DRESSLER HALL



 FICM Code 210 Classroom
 FICM Code 110 Classroom

 = FIRE EXTINGUISHER  = AED  = FIRE DEP. CONNECTION  = LOCK BOX  = FIRE ALARM CONTROL PANEL  = SPRINKLER HEADER **R** = SPRINKLER RISER  = Bottle Filler

DATE REVISED 10/09/2020	ADDRESS 1128 Elm Street	Square Feet 5247	BLDG NO 1171	(DRE) DRESSLER HALL ENTRY FLOOR	FLOOR 0
----------------------------	----------------------------	---------------------	-----------------	------------------------------------	------------

FIRST FLOOR PLAN
DRESSLER HALL

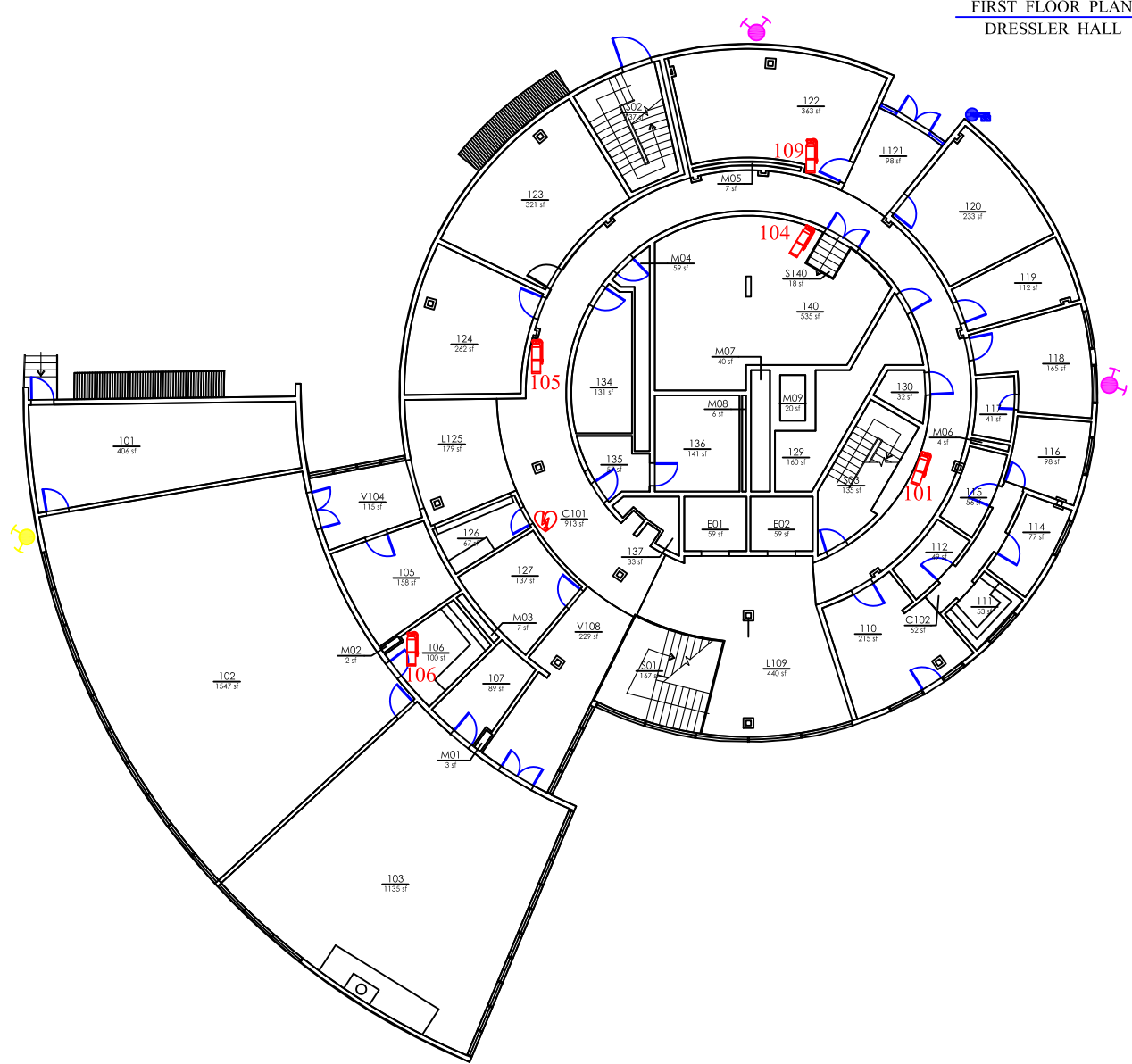



FICM Code 210 Classroom
 FICM Code 110 Classroom

= FIRE EXTINGUISHER = AED = FIRE DEP. CONNECTION = LOCK BOX = FIRE ALARM CONTROL PANEL = SPRINKLER HEADER **R** = SPRINKLER RISER = Bottle Filler

DATE REVISED 10/09/2020	ADDRESS 1128 Elm Street	Square Feet 10515	BLDG NO 1171	(DRE) DRESSLER HALL FIRST FLOOR	FLOOR 1
----------------------------	----------------------------	----------------------	-----------------	------------------------------------	------------

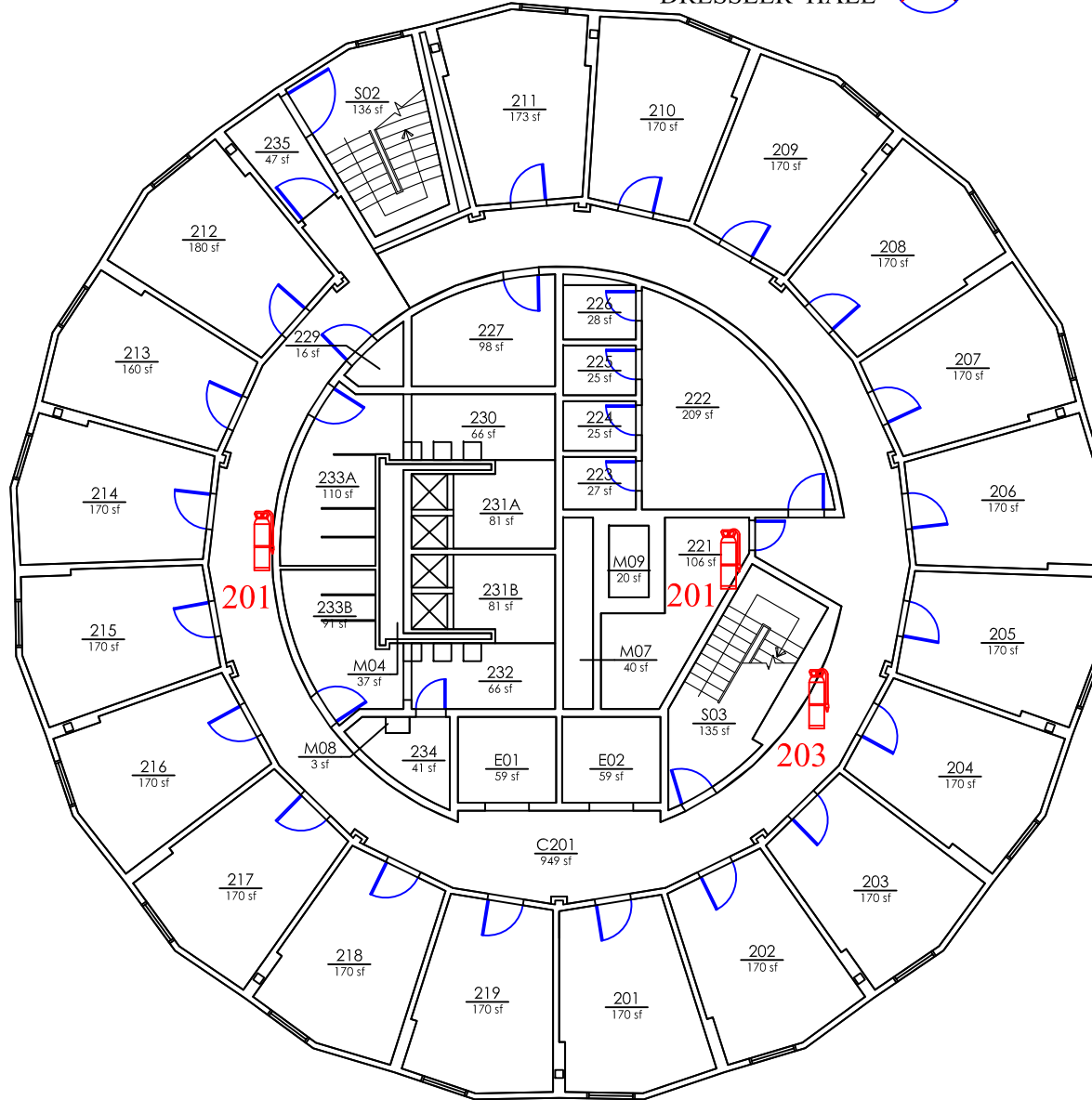
SECOND FLOOR
DRESSLER HALL



 FICM Code 210 Classroom
 FICM Code 110 Classroom

 = FIRE EXTINGUISHER  = AED  = FIRE DEP. CONNECTION  = LOCK BOX  = FIRE ALARM CONTROL PANEL  = SPRINKLER HEADER **R** = SPRINKLER RISER  = Bottle Filler

DATE REVISED 10/12/2020	ADDRESS 1128 Elm Street	Square Feet 6573	BLDG NO 1171	(DRE) DRESSLER HALL SECOND FLOOR	FLOOR 2
----------------------------	----------------------------	---------------------	-----------------	-------------------------------------	------------

THIRD FLOOR
DRESSLER HALL

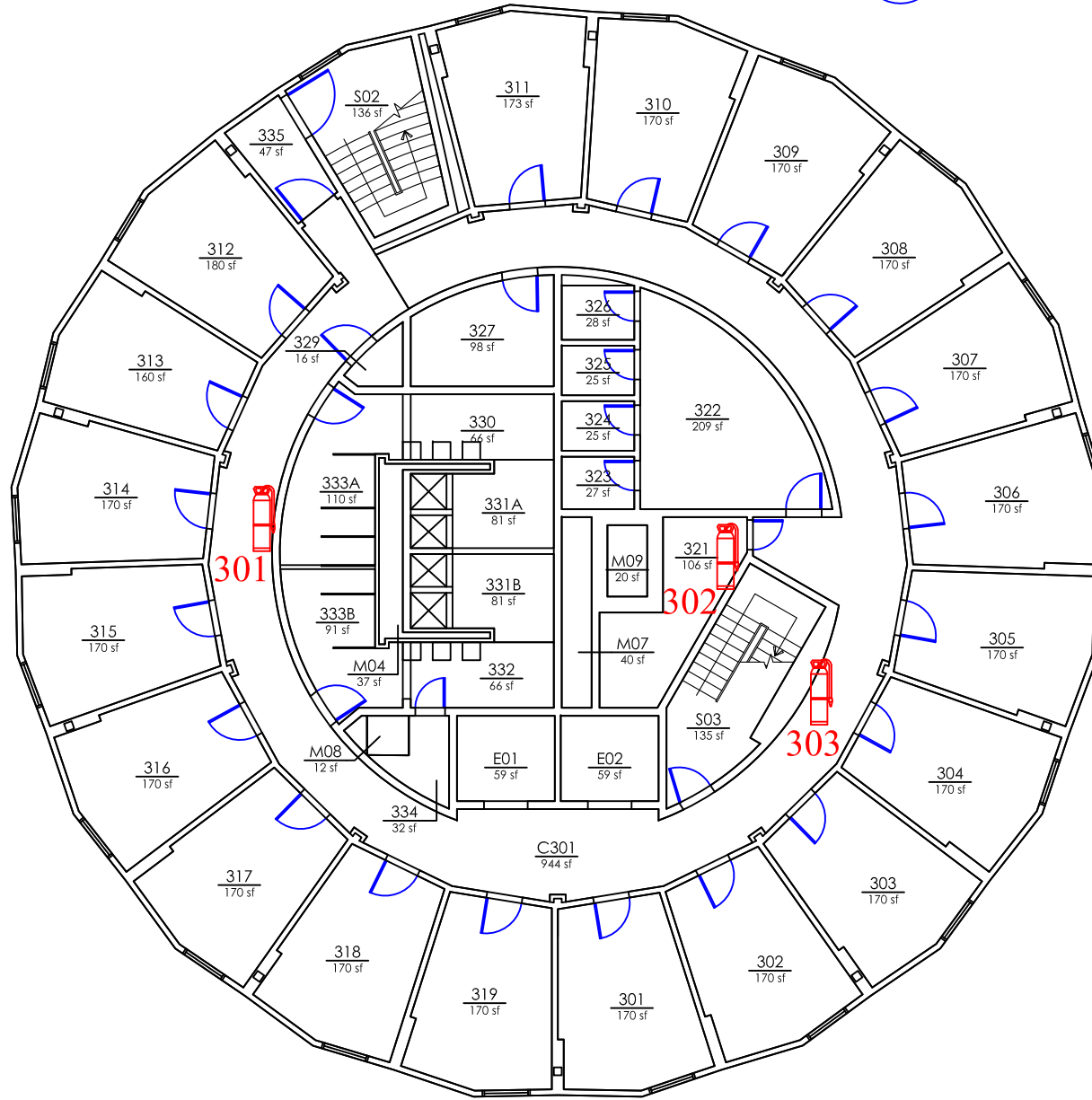

FICM Code 210 Classroom
 FICM Code 110 Classroom

= FIRE EXTINGUISHER = AED = FIRE DEP. CONNECTION = LOCK BOX = FIRE ALARM CONTROL PANEL = SPRINKLER HEADER = SPRINKLER RISER = Bottle Filler

DATE REVISED 10/12/2020	ADDRESS 1128 Elm Street	Square Feet 6572	BLDG NO 1171	(DRE) DRESSLER HALL THIRD FLOOR	FLOOR 3
----------------------------	----------------------------	---------------------	-----------------	------------------------------------	------------

FOURTH FLOOR
DRESSLER HALL

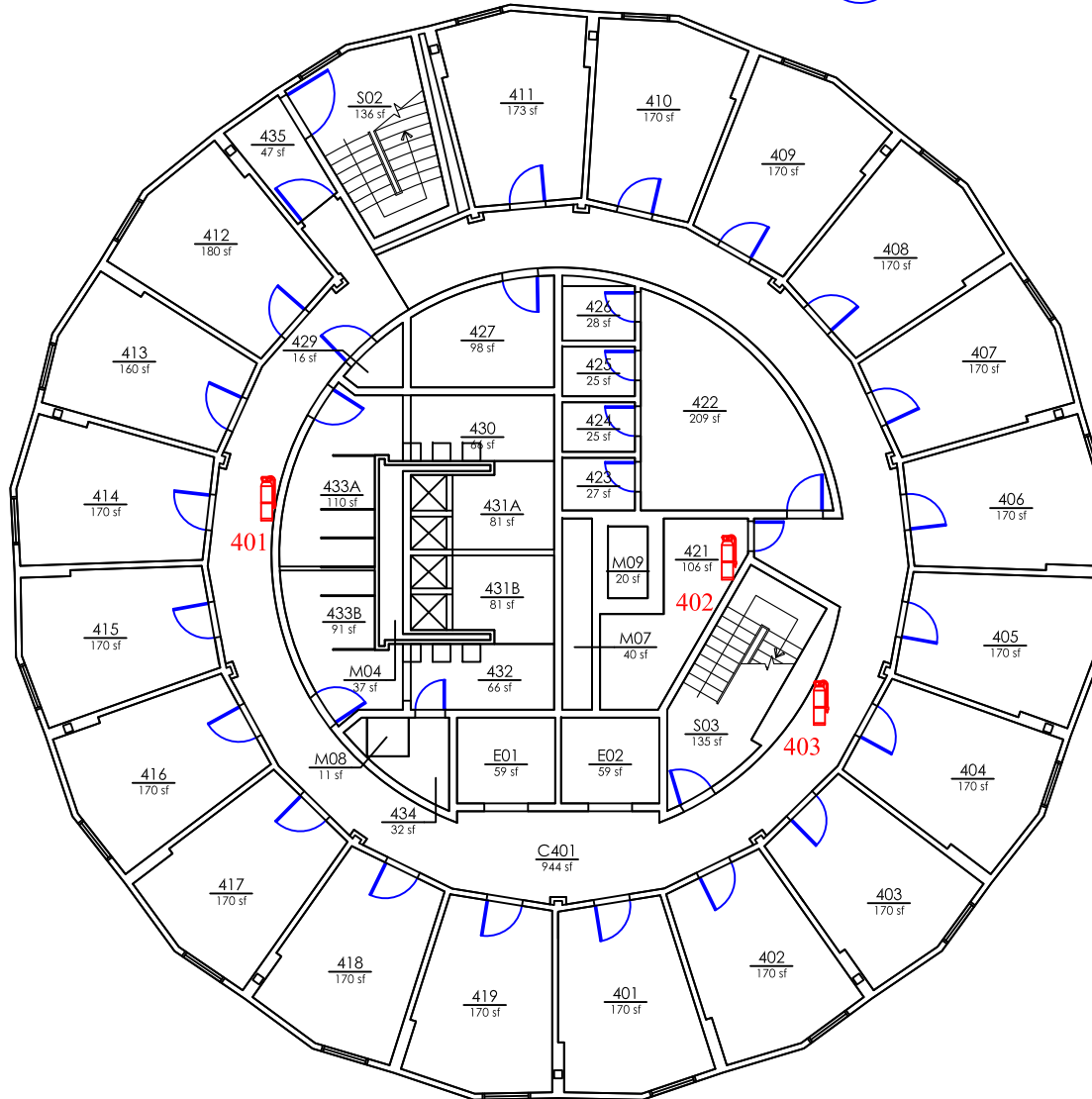

FICM Code 210 Classroom
 FICM Code 110 Classroom

= FIRE EXTINGUISHER = AED = FIRE DEP. CONNECTION = LOCK BOX = FIRE ALARM CONTROL PANEL = SPRINKLER HEADER = SPRINKLER RISER = Bottle Filler

DATE REVISED
10/12/2020

ADDRESS
1128 Elm Street

Square Feet
6527

BLDG NO
1171

(DRE) DRESSLER HALL
FOURTH FLOOR

FLOOR
4

FIFTH FLOOR
DRESSLER HALL

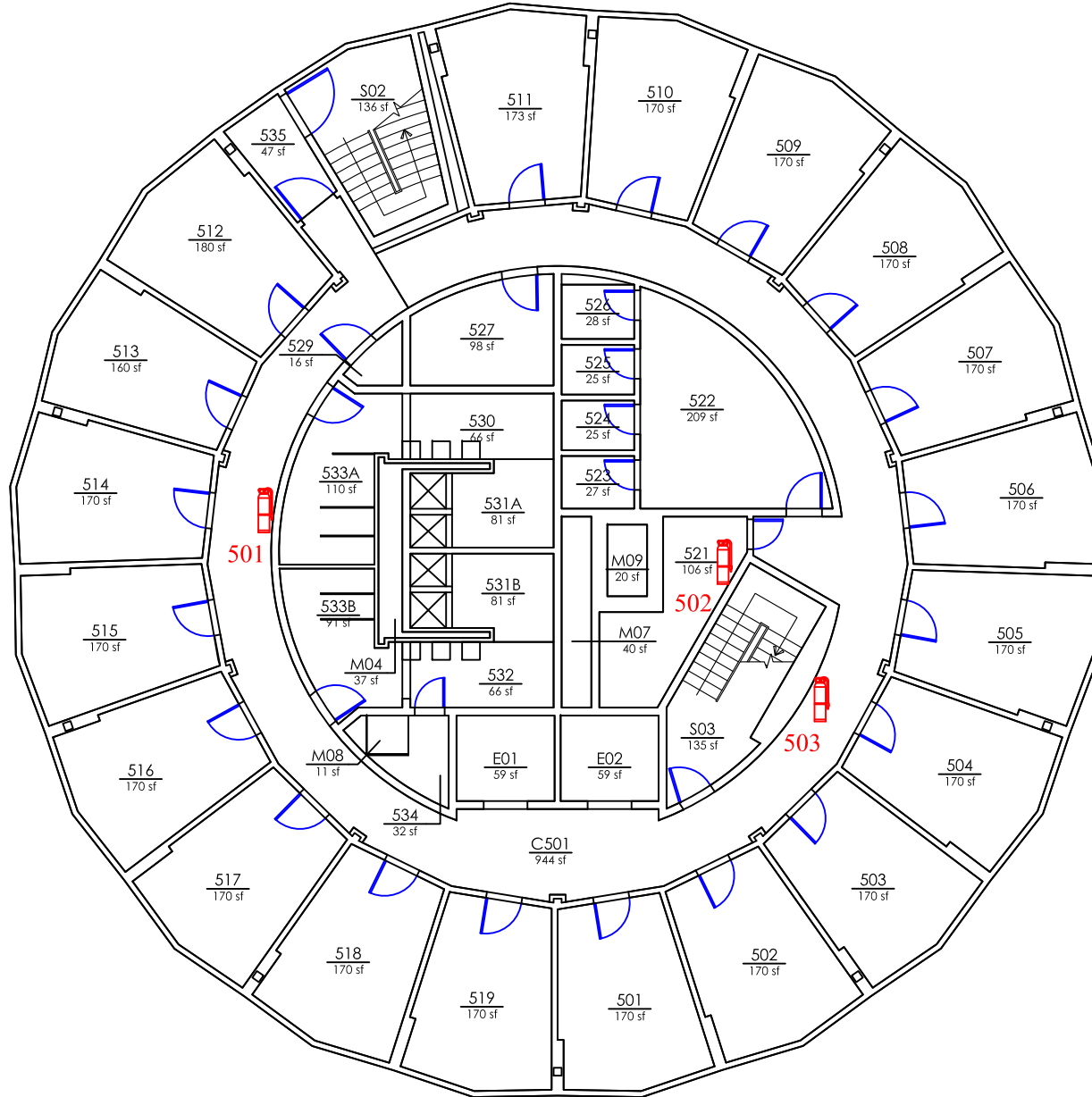

FICM Code 210 Classroom
 FICM Code 110 Classroom

= FIRE EXTINGUISHER = AED = FIRE DEP. CONNECTION = LOCK BOX = FIRE ALARM CONTROL PANEL = SPRINKLER HEADER **R** = SPRINKLER RISER = Bottle Filler

DATE REVISED
10/12/2020

ADDRESS
1128 Elm Street

Square Feet
6572

BLDG NO
1171

(DRE) DRESSLER HALL
FIFTH FLOOR

FLOOR
5

SIXTH FLOOR DRESSLER HALL

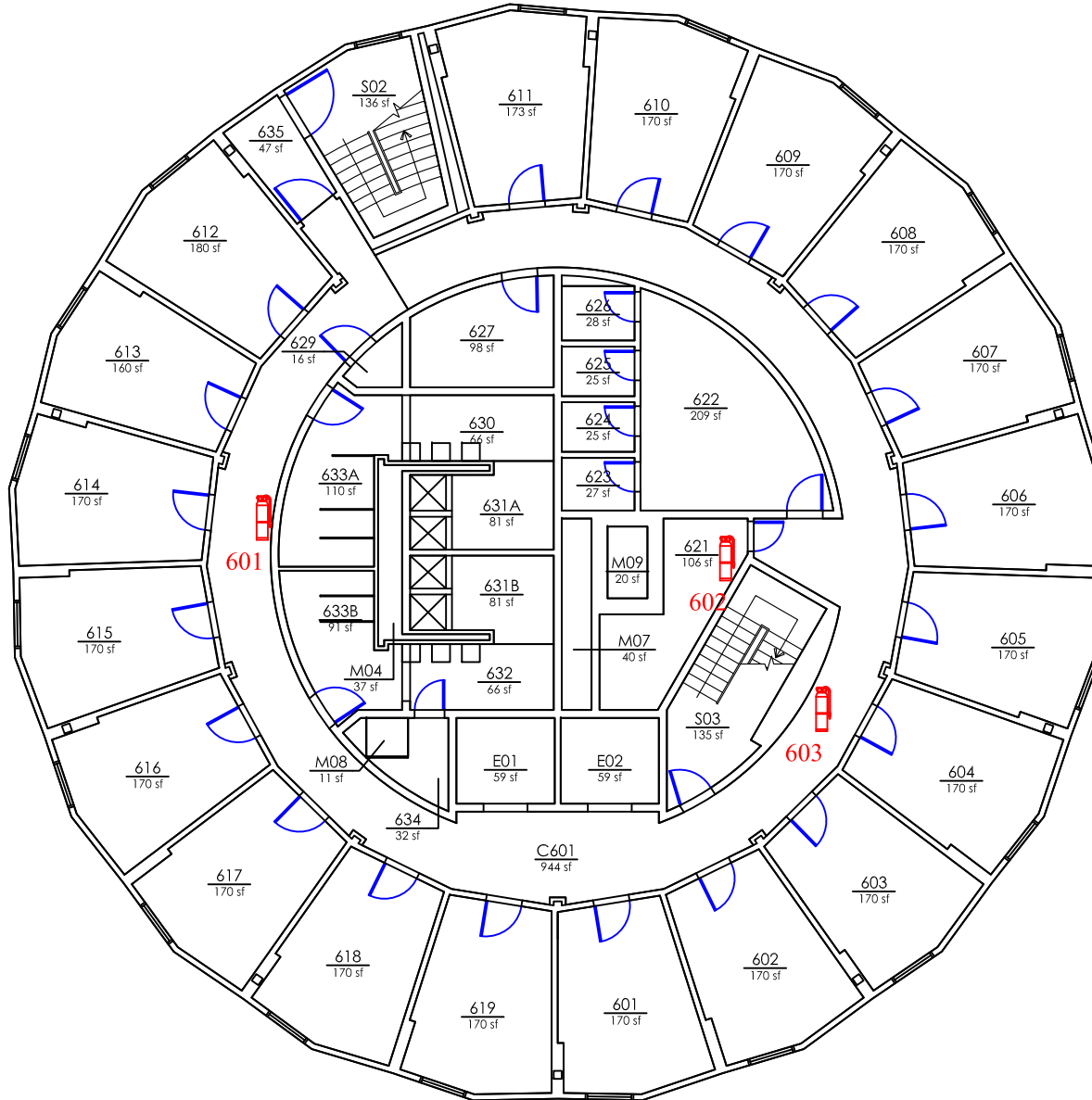

FICM Code 210 Classroom
 FICM Code 110 Classroom

= FIRE EXTINGUISHER = AED = FIRE DEP. CONNECTION = LOCK BOX = FIRE ALARM CONTROL PANEL = SPRINKLER HEADER **R** = SPRINKLER RISER = Bottle Filler

DATE REVISED
10/12/2020

ADDRESS
1128 Elm Street



Square Feet
6572

BLDG NO
1171

(DRE) DRESSLER HALL
SIXTH FLOOR

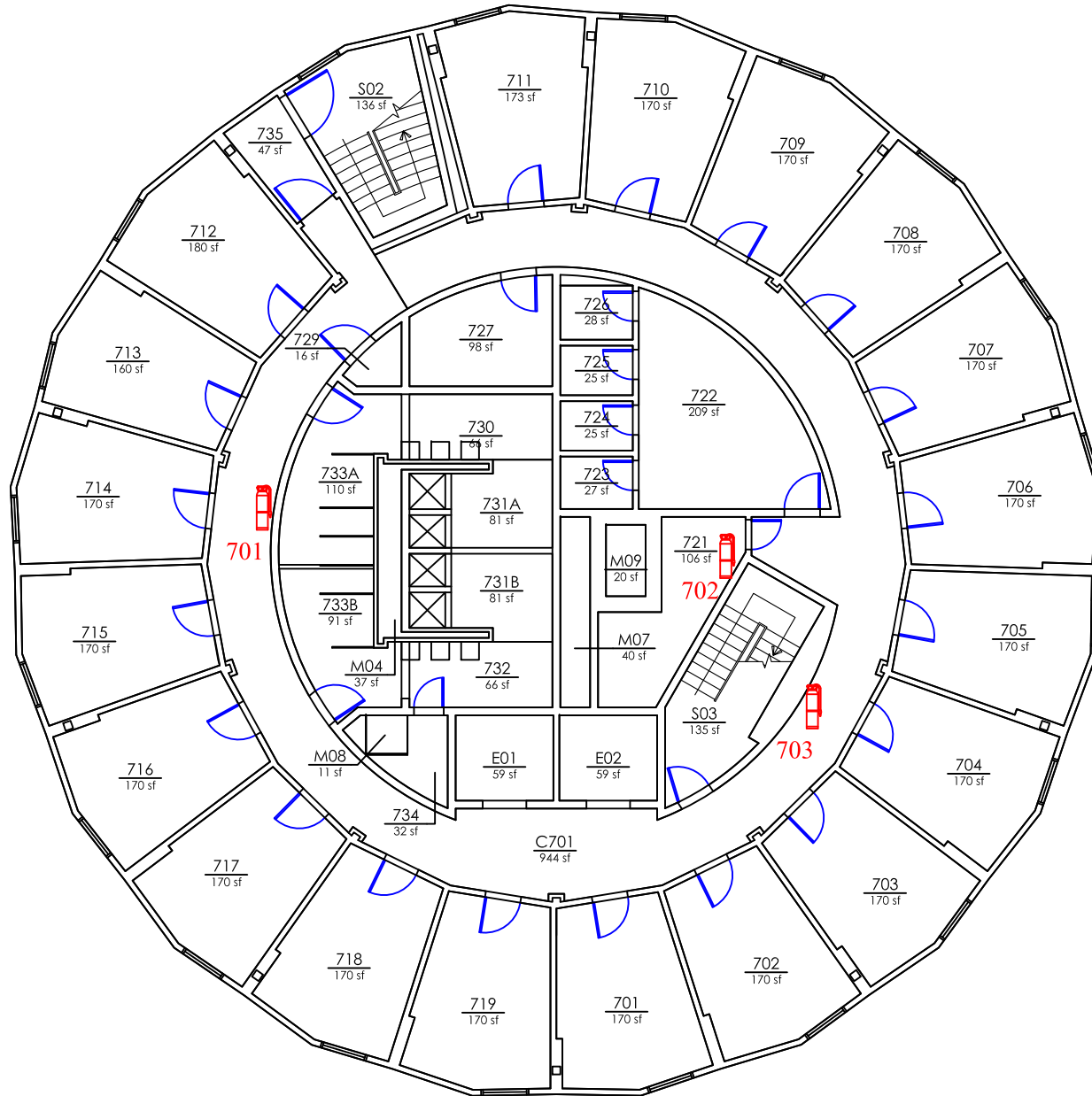
FLOOR
6



 FICM Code 210 Classroom
 FICM Code 110 Classroom

 = FIRE EXTINGUISHER  = AED  = FIRE DEP. CONNECTION  = LOCK BOX  = FIRE ALARM CONTROL PANEL  = SPRINKLER HEADER **R** = SPRINKLER RISER  = Bottle Filler

DATE REVISED
10/12/2020

ADDRESS
1128 Elm Street



Square Feet
6572

BLDG NO
1171

(DRE) DRESSLER HALL
SEVENTH FLOOR

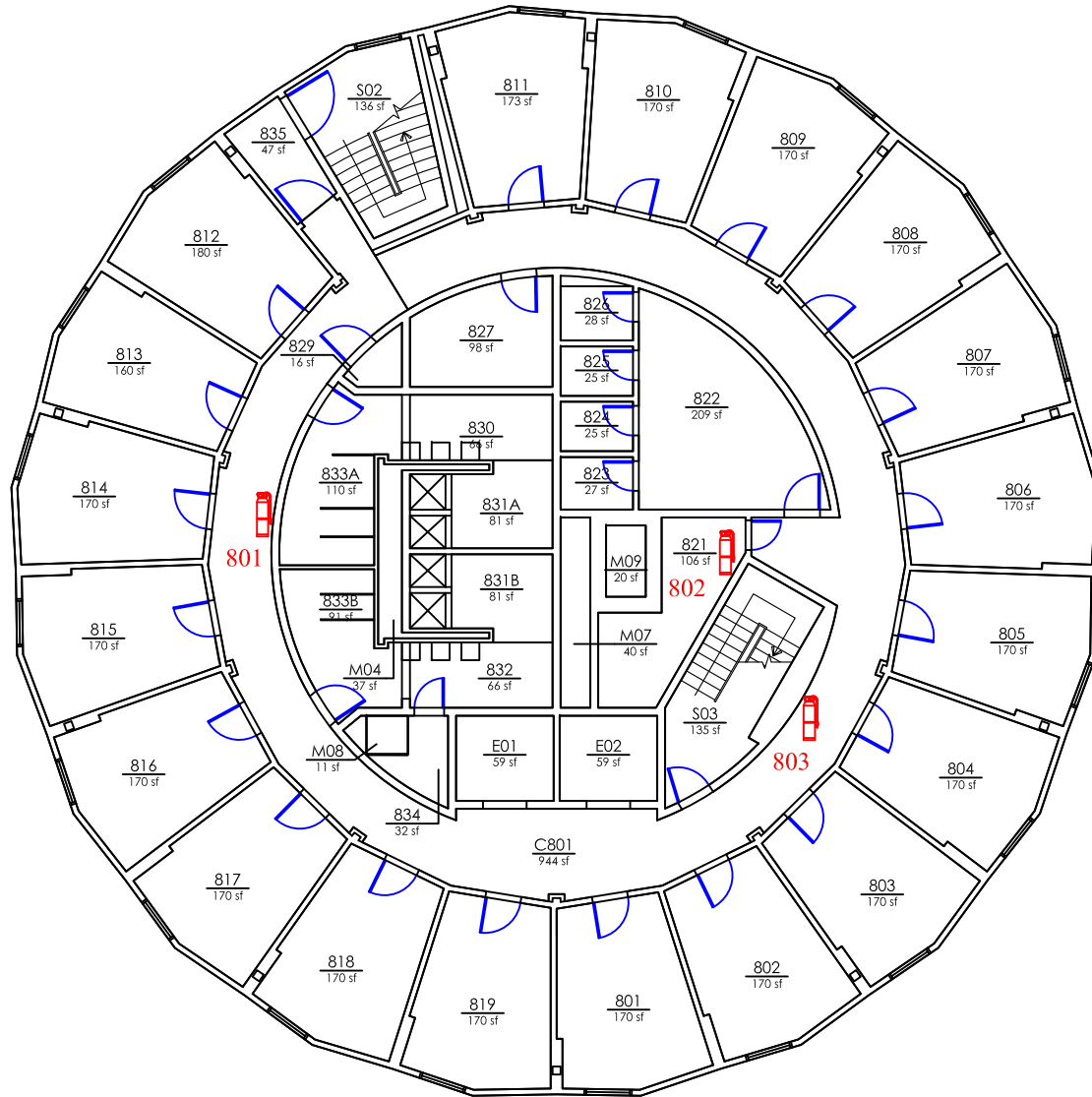
FLOOR
7





 FICM Code 210 Classroom
 FICM Code 110 Classroom

 = FIRE EXTINGUISHER  = AED  = FIRE DEP. CONNECTION  = LOCK BOX  = FIRE ALARM CONTROL PANEL  = SPRINKLER HEADER **R** = SPRINKLER RISER  = Bottle Filler

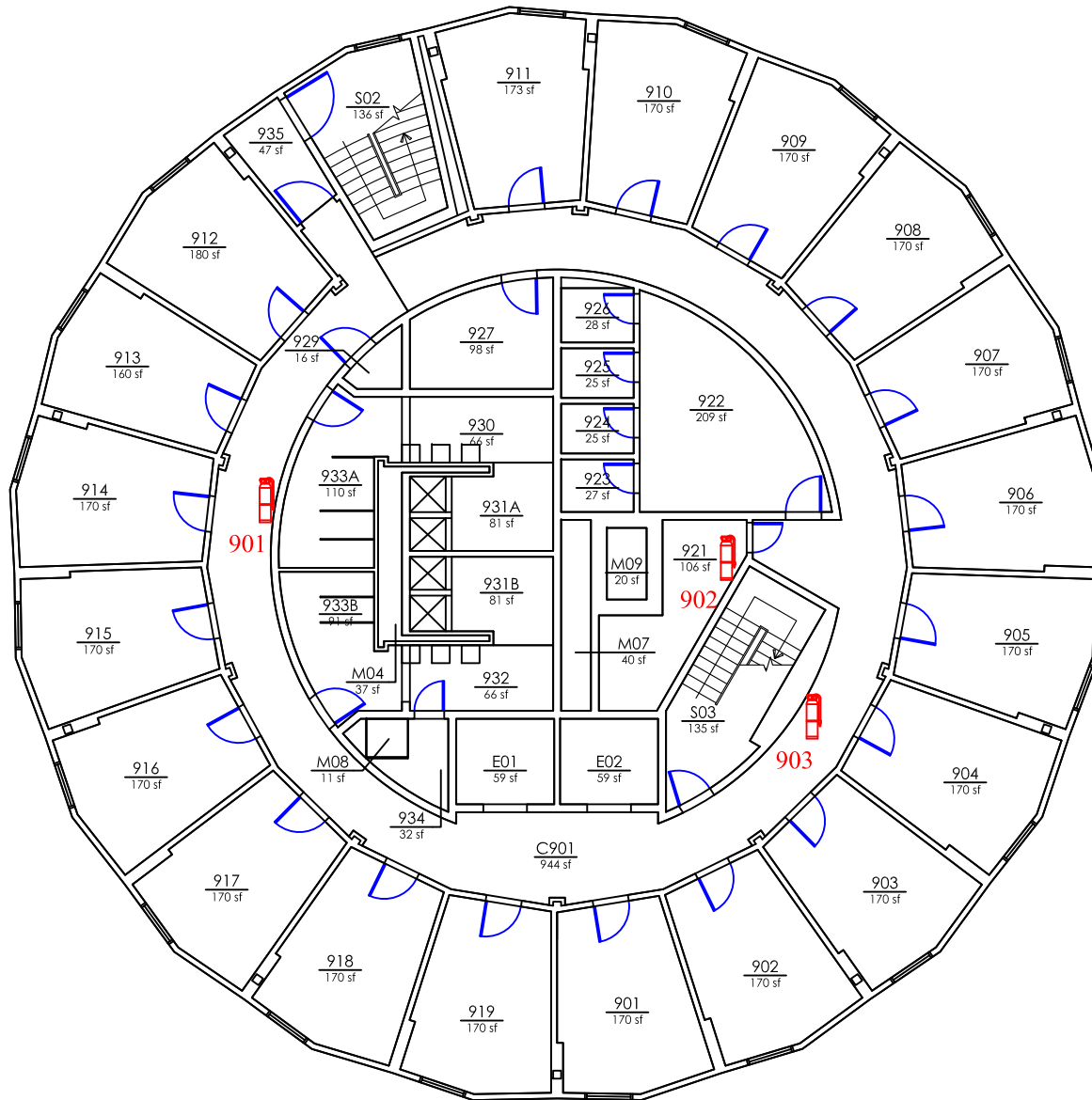
DATE REVISED 10/12/2020	ADDRESS 1128 Elm Street	Square Feet 6572	BLDG NO 1171	(DRE) DRESSLER HALL EIGHTH FLOOR	FLOOR 8
----------------------------	----------------------------	---------------------	-----------------	-------------------------------------	------------





 FICM Code 210 Classroom
 FICM Code 110 Classroom

 = FIRE EXTINGUISHER  = AED  = FIRE DEP. CONNECTION  = LOCK BOX  = FIRE ALARM CONTROL PANEL  = SPRINKLER HEADER **R** = SPRINKLER RISER  = Bottle Filler

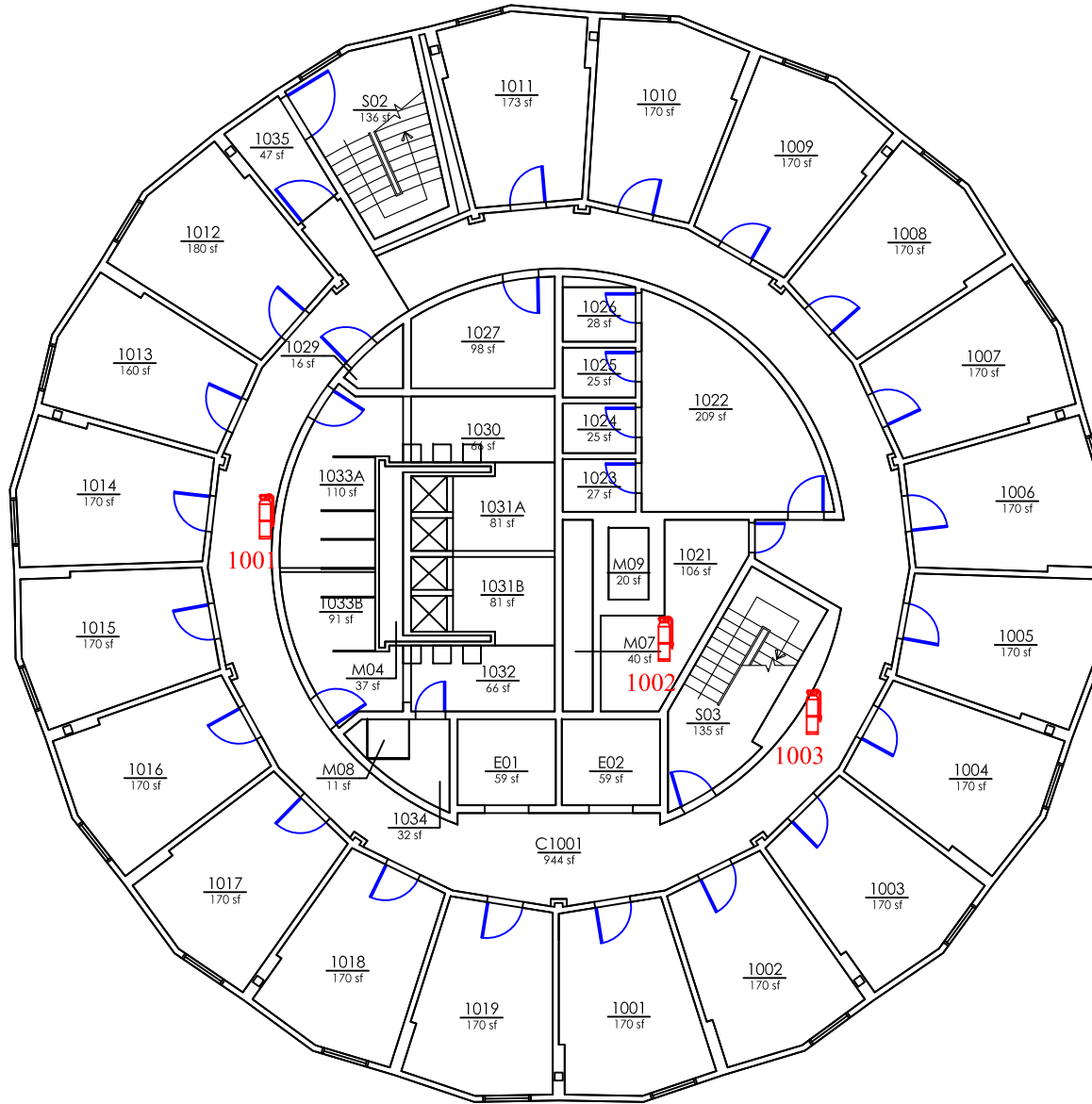
DATE REVISED 10/12/2020	ADDRESS 1128 Elm Street	Square Feet 6572	BLDG NO 1171	(DRE) DRESSLER HALL NINTH FLOOR	FLOOR 9
----------------------------	----------------------------	---------------------	-----------------	------------------------------------	------------



 FICM Code 210 Classroom
 FICM Code 110 Classroom

 = FIRE EXTINGUISHER  = AED  = FIRE DEP. CONNECTION  = LOCK BOX  = FIRE ALARM CONTROL PANEL  = SPRINKLER HEADER **R** = SPRINKLER RISER  = Bottle Filler

DATE REVISED 10/12/2020	ADDRESS 1128 Elm Street	Square Feet 6572	BLDG NO 1171	(DRE) DRESSLER HALL TENTH FLOOR	FLOOR 10
----------------------------	----------------------------	---------------------	-----------------	------------------------------------	-------------

PENTHOUSE FLOOR PLAN
DRESSLER HALL

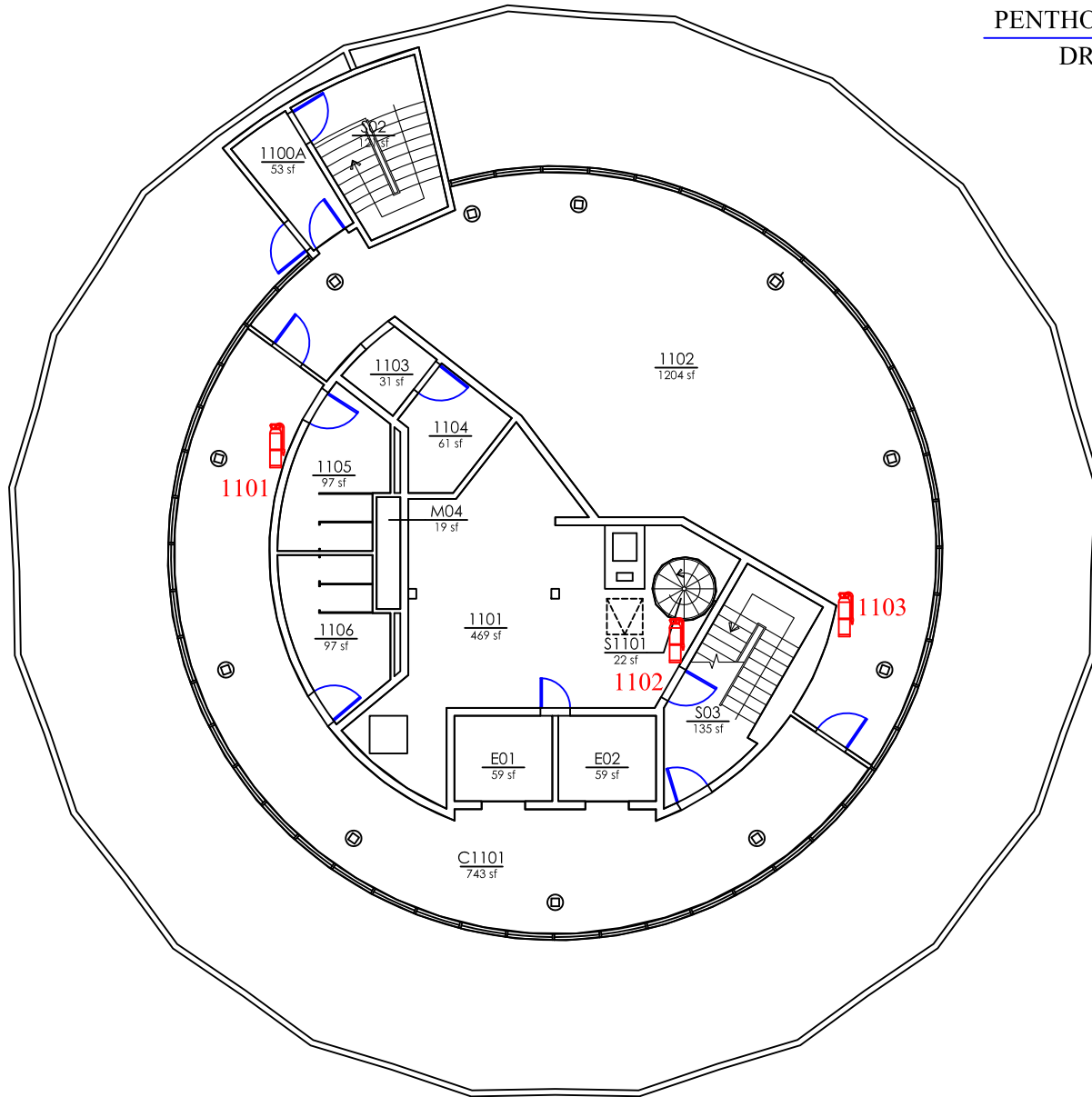



FICM Code 210 Classroom
 FICM Code 110 Classroom

= FIRE EXTINGUISHER = AED = FIRE DEP. CONNECTION = LOCK BOX = FIRE ALARM CONTROL PANEL = SPRINKLER HEADER **R** = SPRINKLER RISER = Bottle Filler

DATE REVISED 10/12/2020	ADDRESS 1128 Elm Street	Square Feet 3498	BLDG NO 1171	(DRE) DRESSLER HALL PENTHOUSE	FLOOR 11
----------------------------	----------------------------	---------------------	-----------------	----------------------------------	-------------

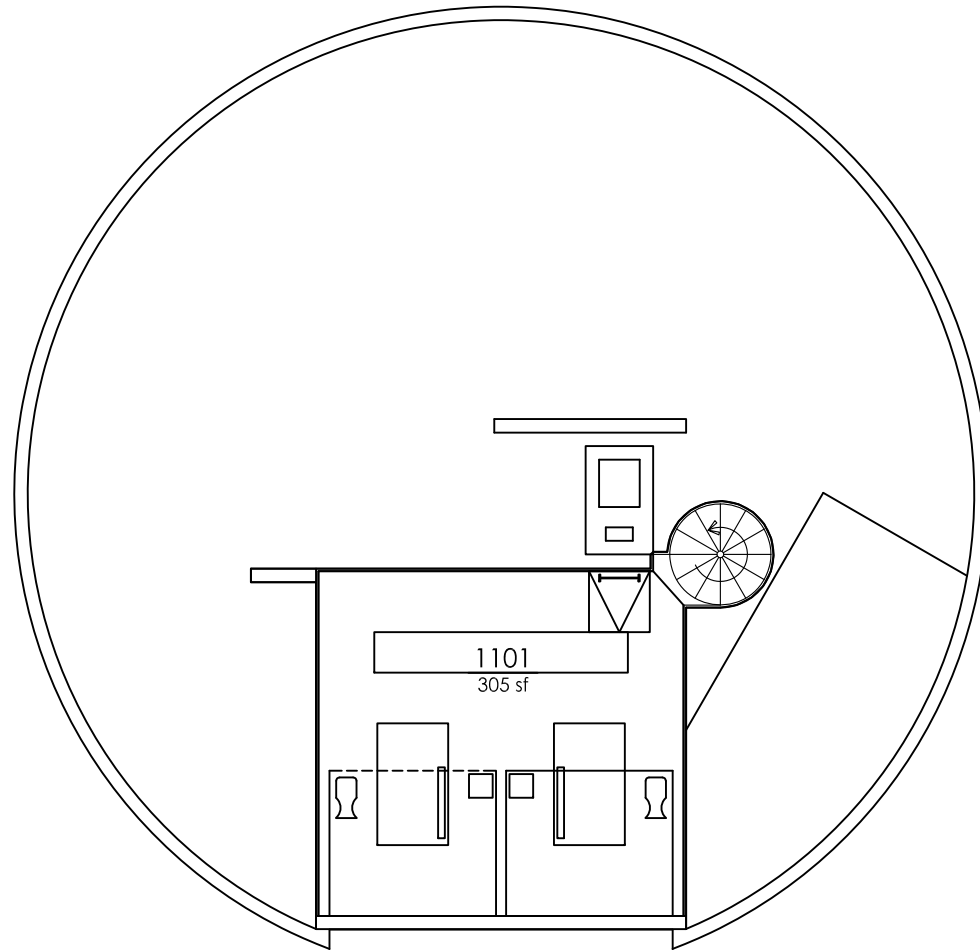
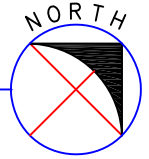
ELEVATOR MACHINE ROOM DRESSLER HALL





 FICM Code 210 Classroom

 FICM Code 110 Classroom

 = FIRE EXTINGUISHER

 = AED

 = FIRE DEP. CONNECTION

 = LOCK BOX

 = FIRE ALARM CONTROL PANEL

 = SPRINKLER HEADER

R = SPRINKLER RISER

 = Bottle Filler

DATE REVISED
10/13/2020

ADDRESS
1128 Elm Street

Square Feet
348

BLDG NO
1171

(DRE) DRESSLER HALL
ELEVATOR MACHINE ROOM

FLOOR
12

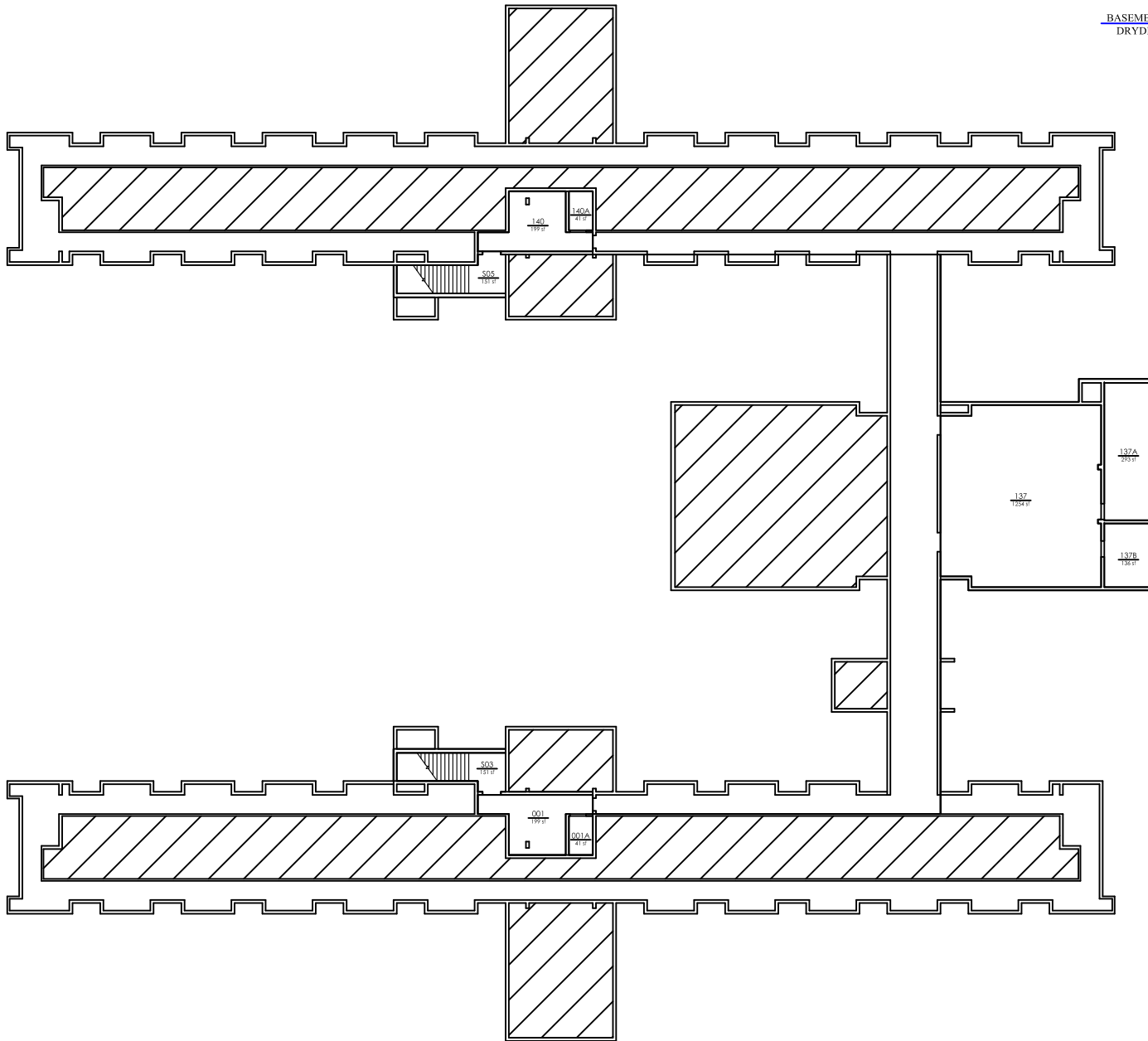

 FICM Code 210 Classroom

 FICM Code 110 Classroom

 = FIRE EXTINGUISHER

 = AED

 = FIRE DEP. CONNECTION

 = LOCK BOX

 = FIRE ALARM CONTROL PANEL

 = SPRINKLER HEADER

 = SPRINKLER RISER

 = Bottle Filler

DATE REVISED
10/13/2020

ADDRESS
106 N. 9th Street



Square Feet
2727

BLDG NO
1480

(DRE) DRYDEN HALL
BASEMENT

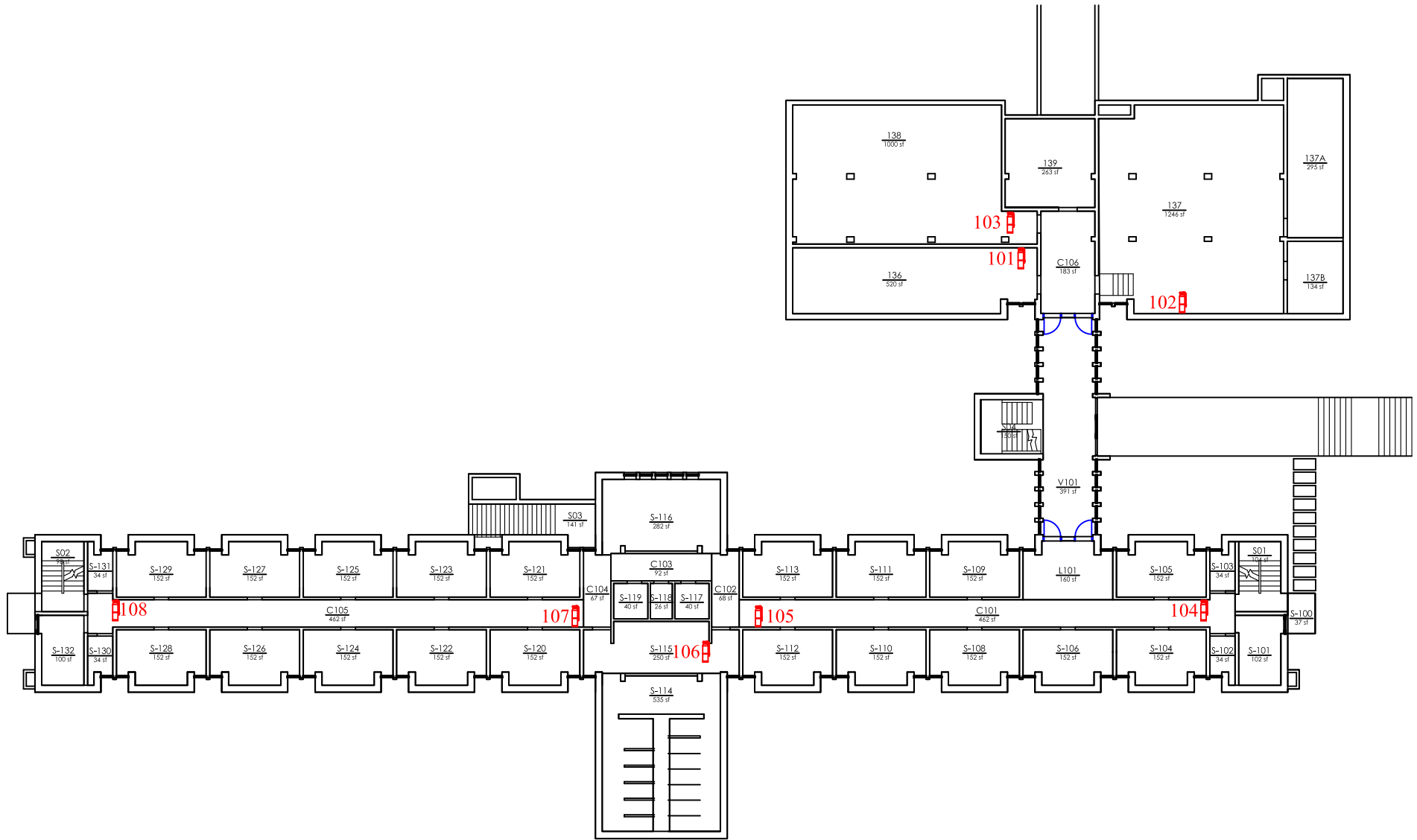
FLOOR
0



 FICM Code 210 Classroom
 FICM Code 110 Classroom



 = FIRE EXTINGUISHER  = AED  = FIRE DEP. CONNECTION  = LOCK BOX  = FIRE ALARM CONTROL PANEL  = SPRINKLER HEADER  = SPRINKLER RISER  = Bottle Filler

DATE REVISED 10/13/2020	ADDRESS 106 N 9th Street	Square Feet 12068	BLDG NO 1480	(DRE) DRYDEN HALL FIRST FLOOR	FLOOR 1
----------------------------	-----------------------------	----------------------	-----------------	----------------------------------	------------

DRAWINGS ARE NOT TO SCALE

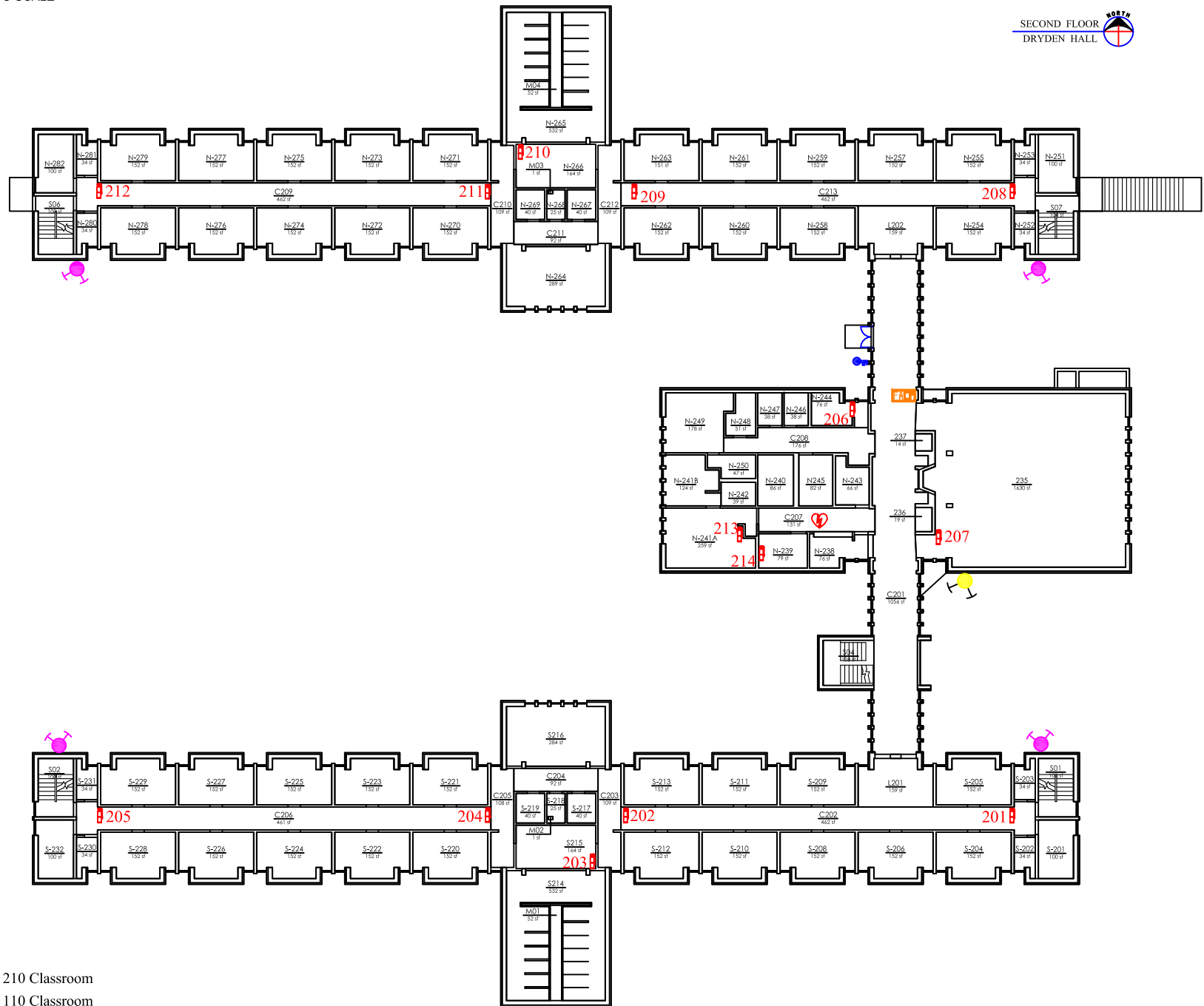
SECOND FLOOR
DRYDEN HALL

 FICM Code 210 Classroom
 FICM Code 110 Classroom

 = FIRE EXTINGUISHER  = AED  = FIRE DEP. CONNECTION  = LOCK BOX  = FIRE ALARM CONTROL PANEL  = SPRINKLER HEADER **R** = SPRINKLER RISER  = Bottle Filler

DATE REVISED 10/13/2020	ADDRESS 106 N. 9th Street	Square Feet 19250	BLDG NO 1480	(DRE) DRYDEN HALL SECOND FLOOR	FLOOR 2
----------------------------	------------------------------	----------------------	-----------------	-----------------------------------	------------

DRAWINGS ARE NOT TO SCALE

THIRD FLOOR
DRYDEN HALL

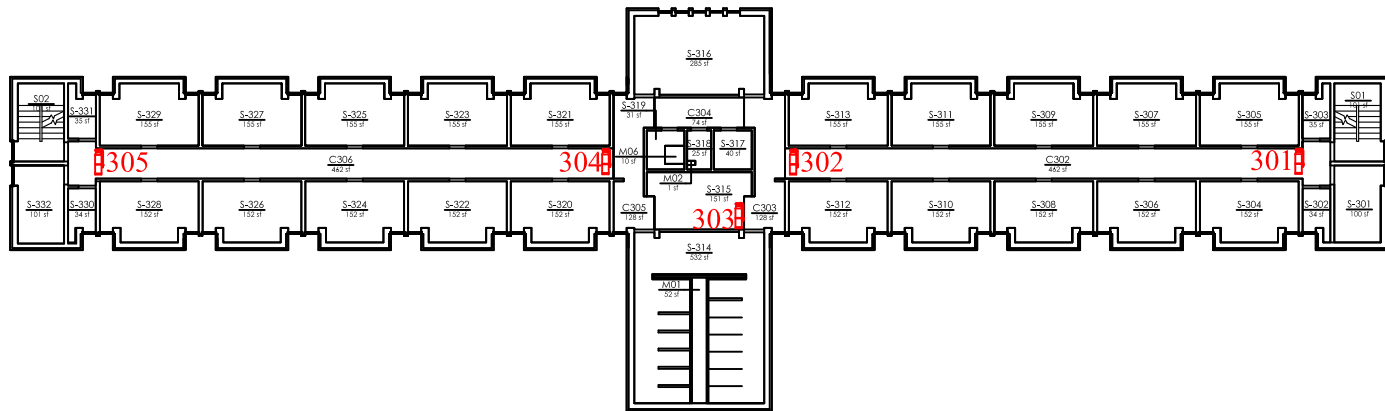
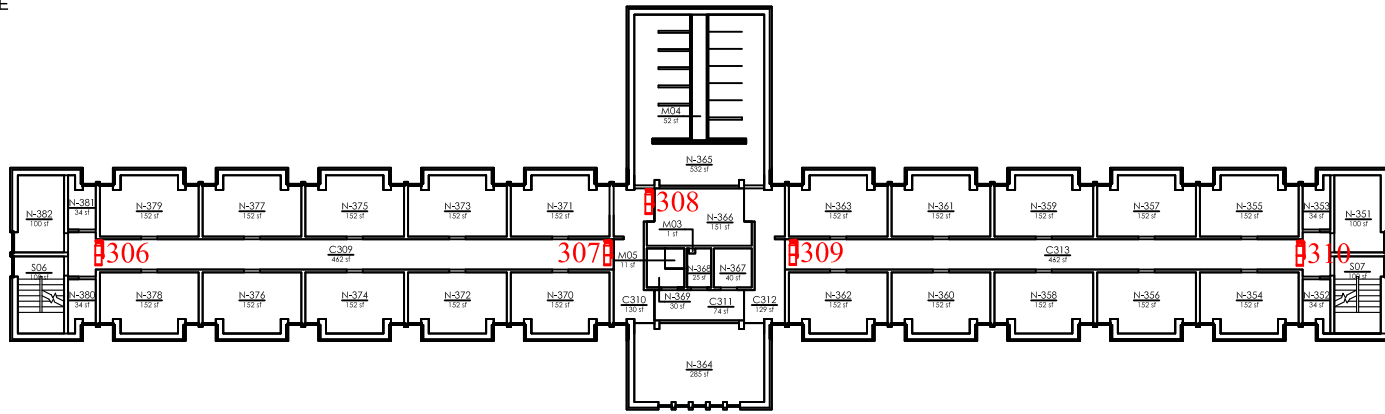

- FICM Code 210 Classroom
- FICM Code 110 Classroom

- = FIRE EXTINGUISHER
- = AED
- = FIRE DEP. CONNECTION
- = LOCK BOX
- = FIRE ALARM CONTROL PANEL
- = SPRINKLER HEADER
- = SPRINKLER RISER
- = Bottle Filler

DATE REVISED
10/13/2020

ADDRESS
106 N. 9th Street



Square Feet
14247

BLDG NO
1480

(DRE) DRYDEN HALL
THIRD FLOOR

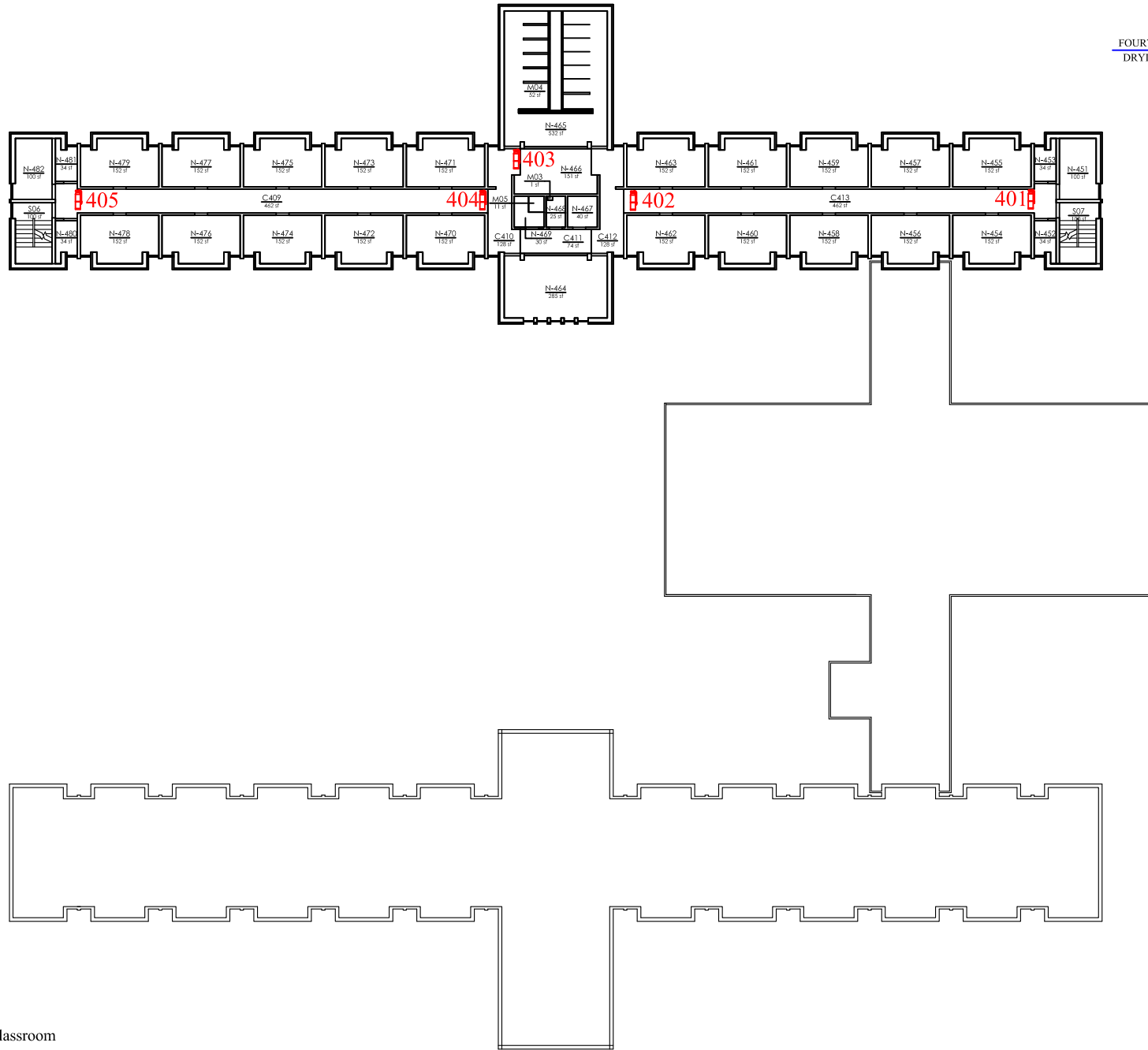
FLOOR
3



 FICM Code 210 Classroom
 FICM Code 110 Classroom

 = FIRE EXTINGUISHER  = AED  = FIRE DEP. CONNECTION  = LOCK BOX  = FIRE ALARM CONTROL PANEL  = SPRINKLER HEADER **R** = SPRINKLER RISER  = Bottle Filler

DATE REVISED 10/14/2020	ADDRESS 106 N. 9th Street	Square Feet 7123	BLDG NO 1480	(DRE) DRYDEN HALL FOURTH FLOOR	FLOOR 4
----------------------------	------------------------------	---------------------	-----------------	-----------------------------------	------------

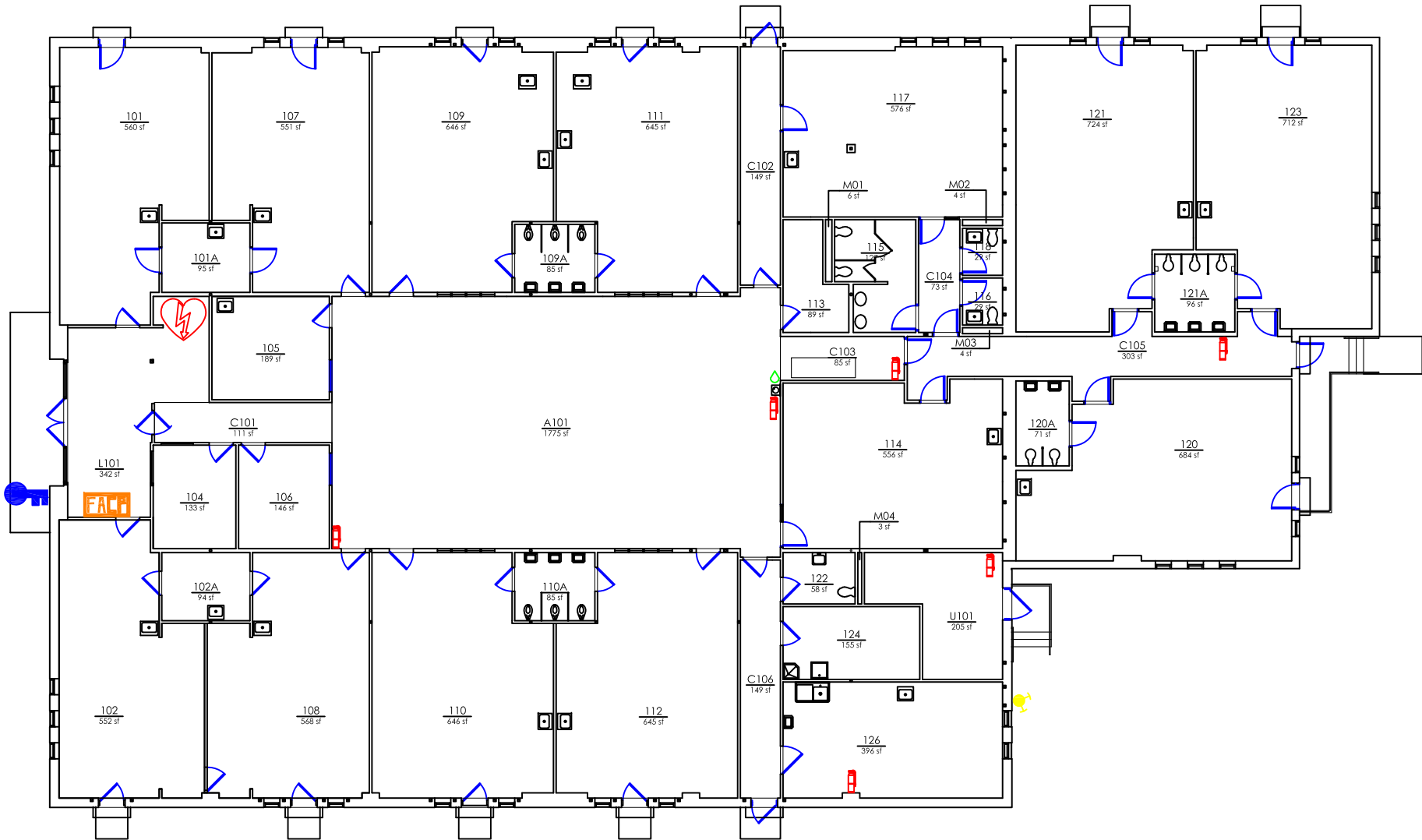

- HOOD Hood
- FICM Code 210 Classroom
- FICM Code 110 Classroom



- = FIRE EXTINGUISHER
- = AED
- = FIRE DEP. CONNECTION
- = LOCK BOX
- = FIRE ALARM CONTROL PANEL
- = SPRINKLER HEADER
- R = SPRINKLER RISER
- = Bottle Filler

DATE REVISED 10/14/2020	ADDRESS 923 Washington Street	Square Feet 14284	BLDG NO 1151	(ECC) EWU CHILDREN'S CENTER FIRST FLOOR	FLOOR 1
----------------------------	----------------------------------	----------------------	-----------------	--	------------

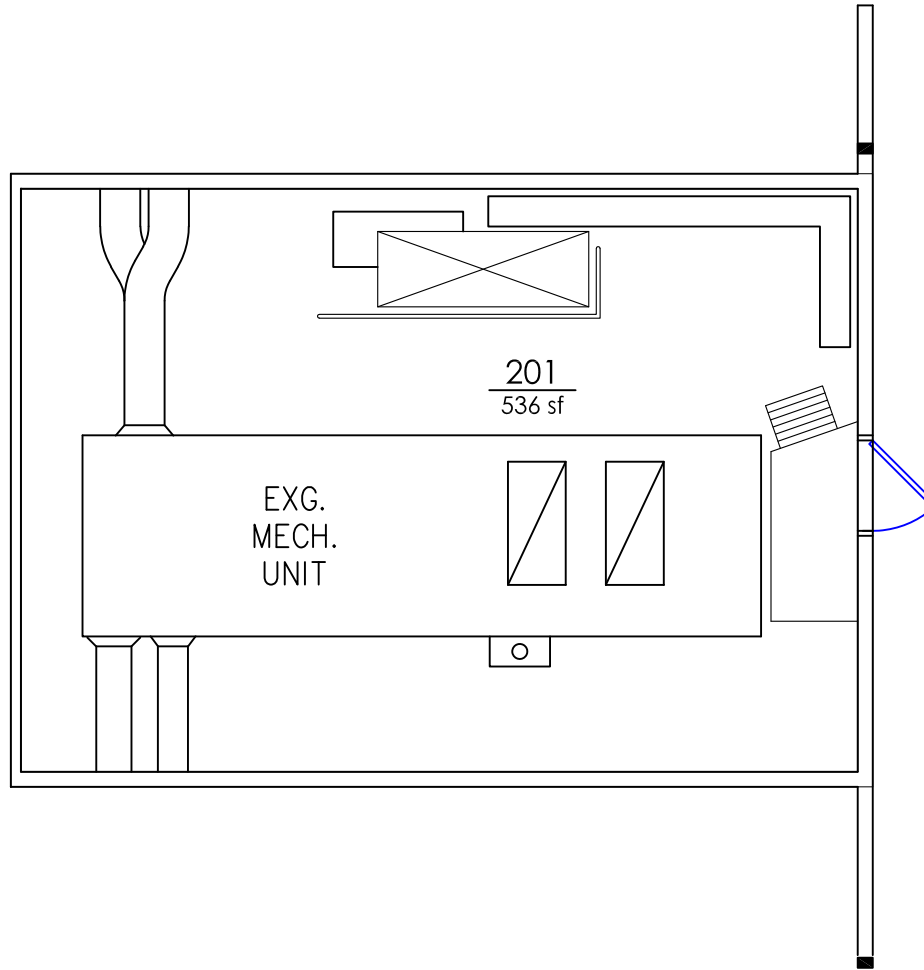

MEZZANINE
EWU CHILD CARE CENTER



 FICM Code 210 Classroom
 FICM Code 110 Classroom

 = FIRE EXTINGUISHER  = AED  = FIRE DEP. CONNECTION  = LOCK BOX  = FIRE ALARM CONTROL PANEL  = SPRINKLER HEADER **R** = SPRINKLER RISER  = Bottle Filler

DATE REVISED
10/14/2020

ADDRESS
923 Washington Street

Square Feet
581



BLDG NO
1154

(ECC) EWU CHILDREN'S CENTER
MEZZANINE

FLOOR
2

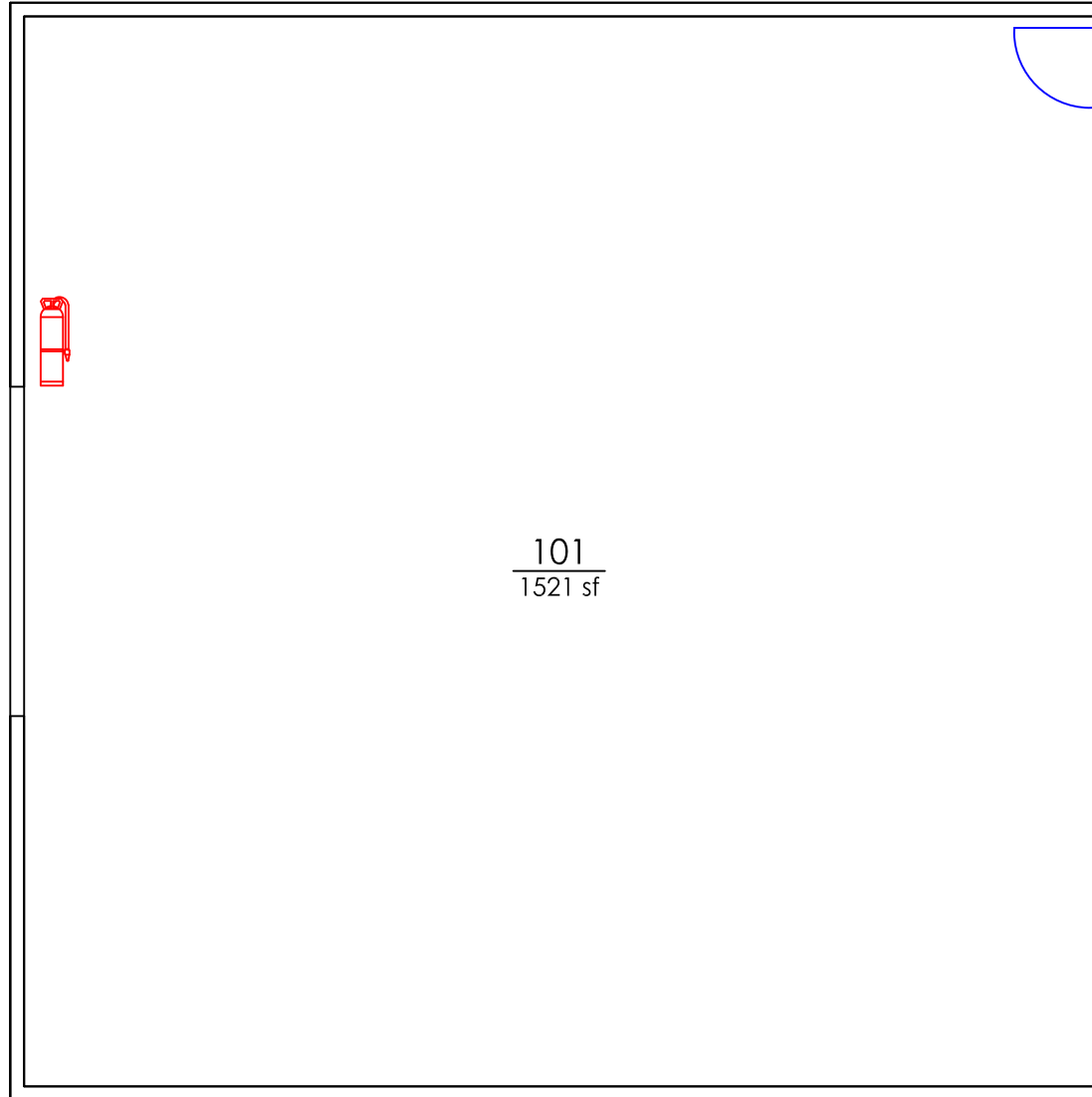
FLOOR PLAN
ELETRICAL STOARAGE



 FICM Code 210 Classroom
 FICM Code 110 Classroom

 = FIRE EXTINGUISHER  = AED  = FIRE DEP. CONNECTION  = LOCK BOX  = FIRE ALARM CONTROL PANEL  = SPRINKLER HEADER **R** = SPRINKLER RISER  = Bottle Filler

DATE REVISED
10/14/2020

ADDRESS
1320 Woodward
LN

Square Feet
1600

BLDG NO
1416

(ESB) ELECTRICAL STORAGE
FLOOR PLAN

FLOOR
1

DRAWINGS ARE NOT TO SCALE

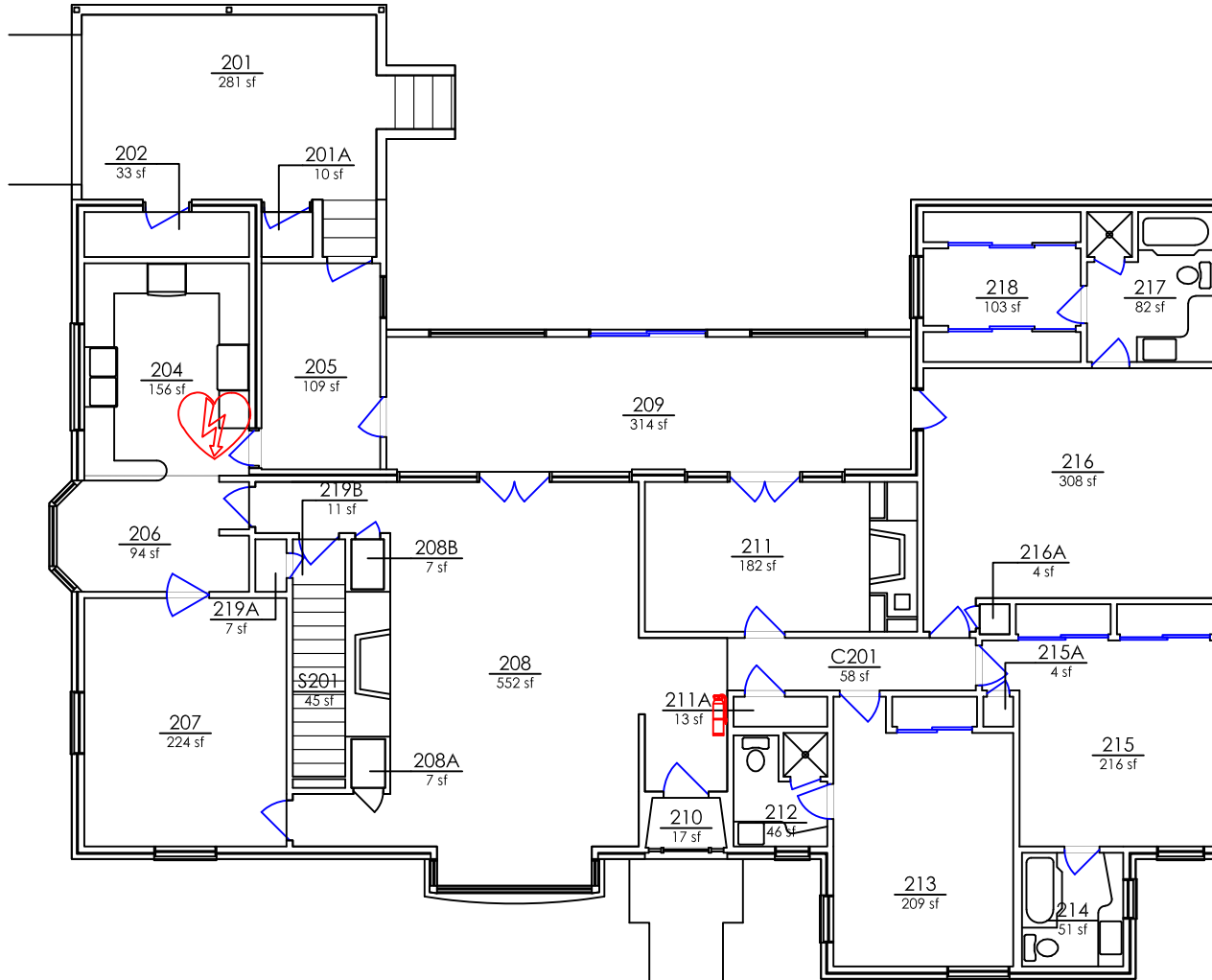

FIRST FLOOR
GOVERNOR MARTIN HOUSE

- FICM Code 210 Classroom
- FICM Code 110 Classroom

- = FIRE EXTINGUISHER
- = AED
- = FIRE DEP. CONNECTION
- = LOCK BOX
- = FIRE ALARM CONTROL PANEL
- = SPRINKLER HEADER
- = SPRINKLER RISER
- = Bottle Filler

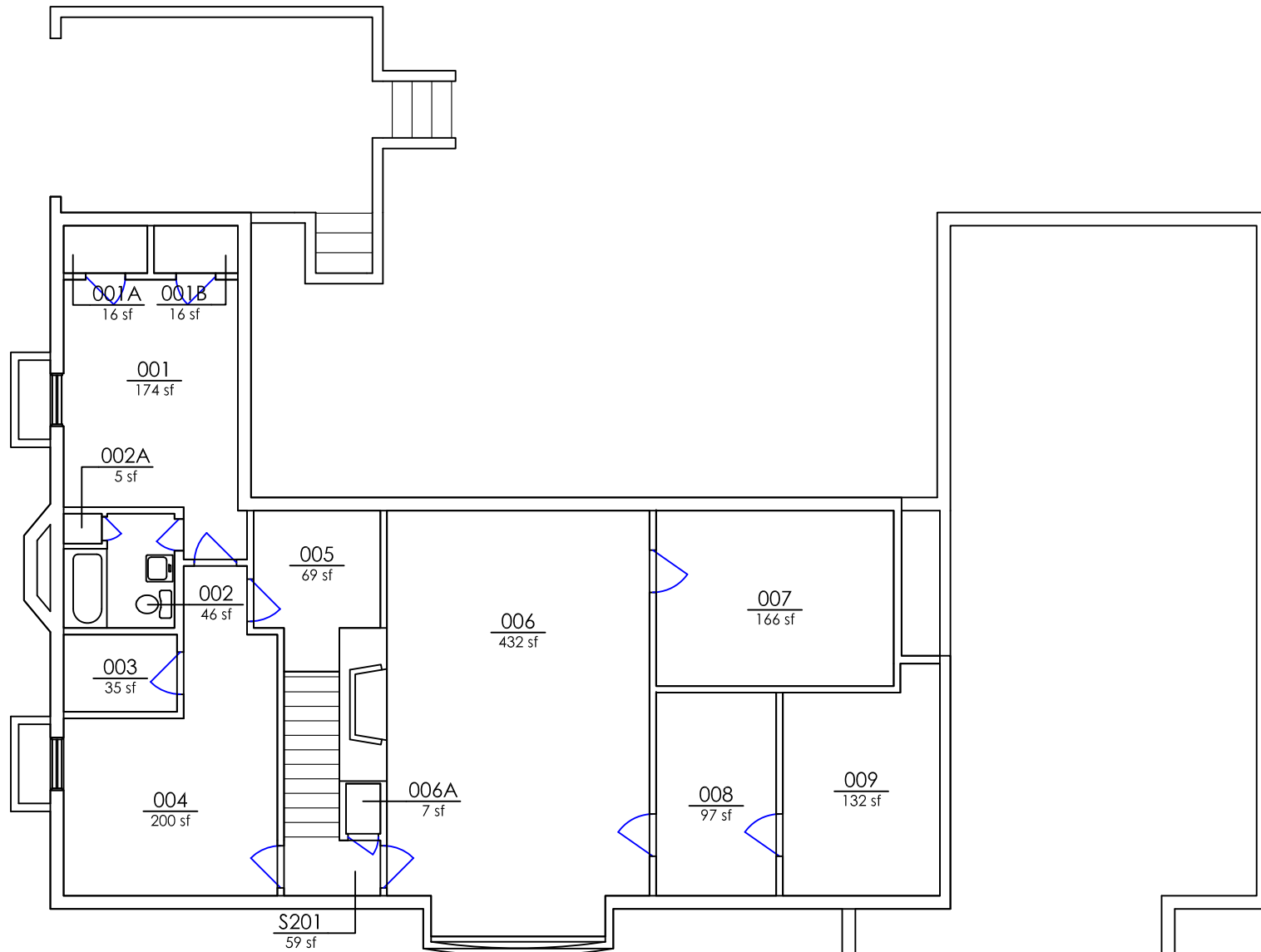

DATE REVISED	ADDRESS	Square Feet	BLDG NO	(FCB) FACULTY COMMONS BUILDING FIRST FLOOR	FLOOR
05/09/2021	506 F Street	3584	1196		1

DRAWINGS ARE NOT TO SCALE



BASEMENT
GOVERNOR MARTIN HOUSE



-  FICM Code 210 Classroom
-  FICM Code 110 Classroom

-  = FIRE EXTINGUISHER
-  = AED
-  = FIRE DEP. CONNECTION
-  = LOCK BOX
-  = FIRE ALARM CONTROL PANEL
-  = SPRINKLER HEADER
-  = SPRINKLER RISER
-  = Bottle Filler

DATE REVISED
02-06-2021

ADDRESS
506 F Street

Square Feet
3584



BLDG NO
1196

(FCB) FACULTY COMMONS BUILDING
FIRST FLOOR

FLOOR
0

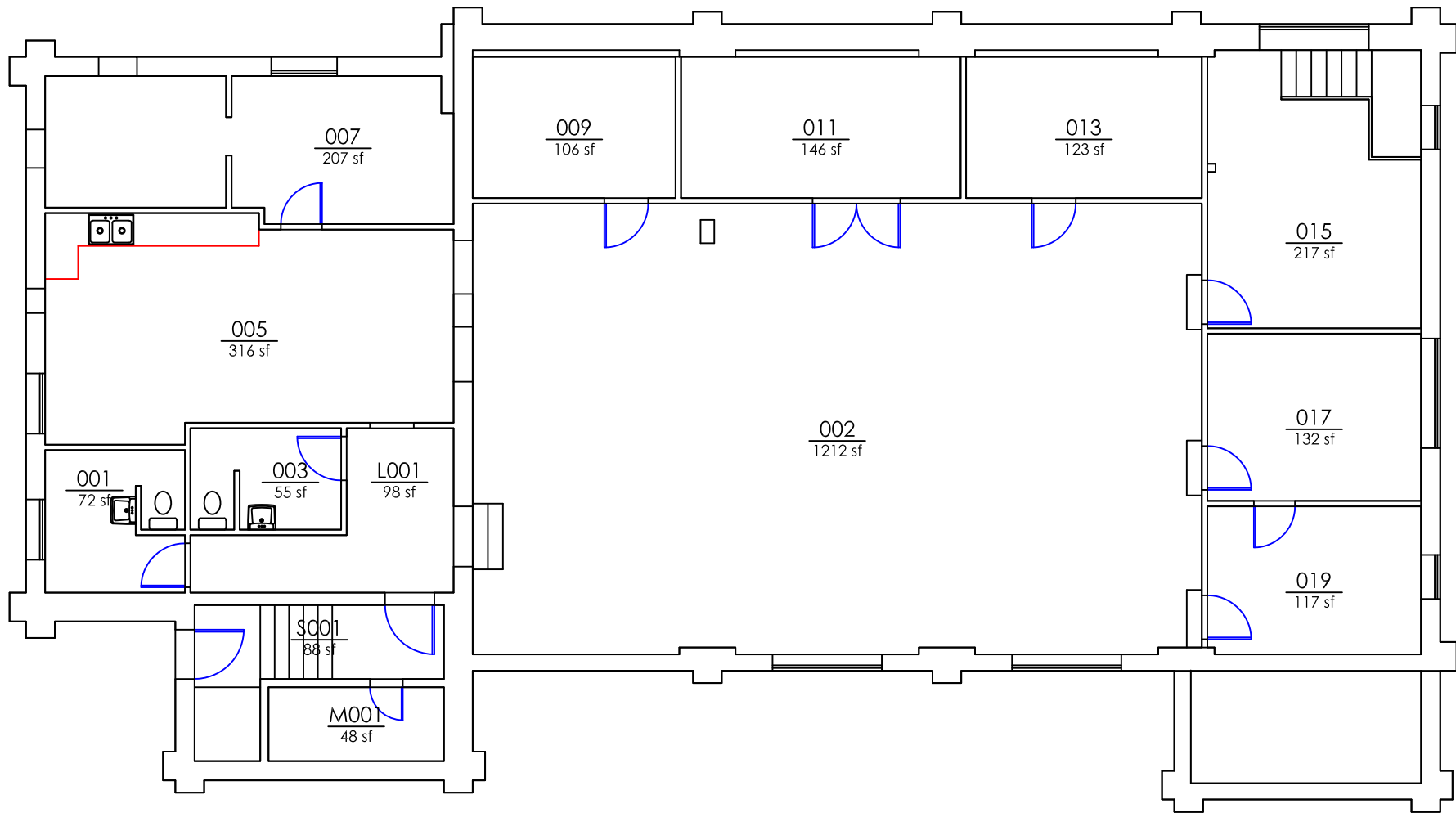
DRAWINGS ARE NOT TO SCALE



 FICM Code 210 Classroom
 FICM Code 110 Classroom

 = FIRE EXTINGUISHER  = AED  = FIRE DEP. CONNECTION  = LOCK BOX  = FIRE ALARM CONTROL PANEL  = SPRINKLER HEADER  = SPRINKLER RISER  = Bottle Filler

DATE REVISED
10/14/2020

ADDRESS
524 5th Street



Square Feet
3488

BLDG NO
1197

(FSH) FIFTH STREET HALL
BASEMENT

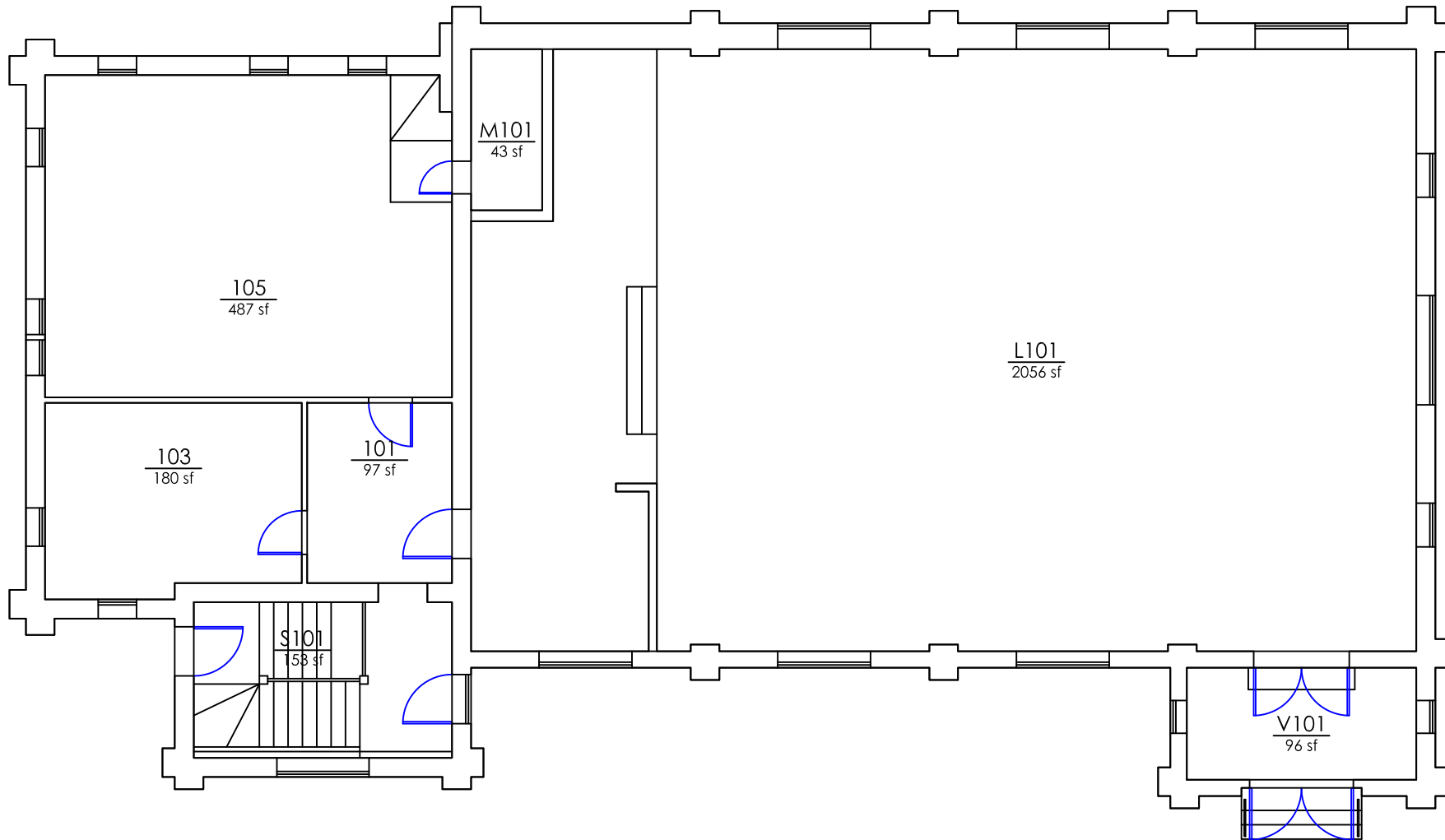
FLOOR
0



 FICM Code 210 Classroom
 FICM Code 110 Classroom

 = FIRE EXTINGUISHER  = AED  = FIRE DEP. CONNECTION  = LOCK BOX  = FIRE ALARM CONTROL PANEL  = SPRINKLER HEADER **R** = SPRINKLER RISER  = Bottle Filler

DATE REVISED
10/14/2020

ADDRESS
524 5th street

Square Feet
3580



BLDG NO
1197

(FSH) FIFTH STREET HALL
FIRST FLOOR

FLOOR
1

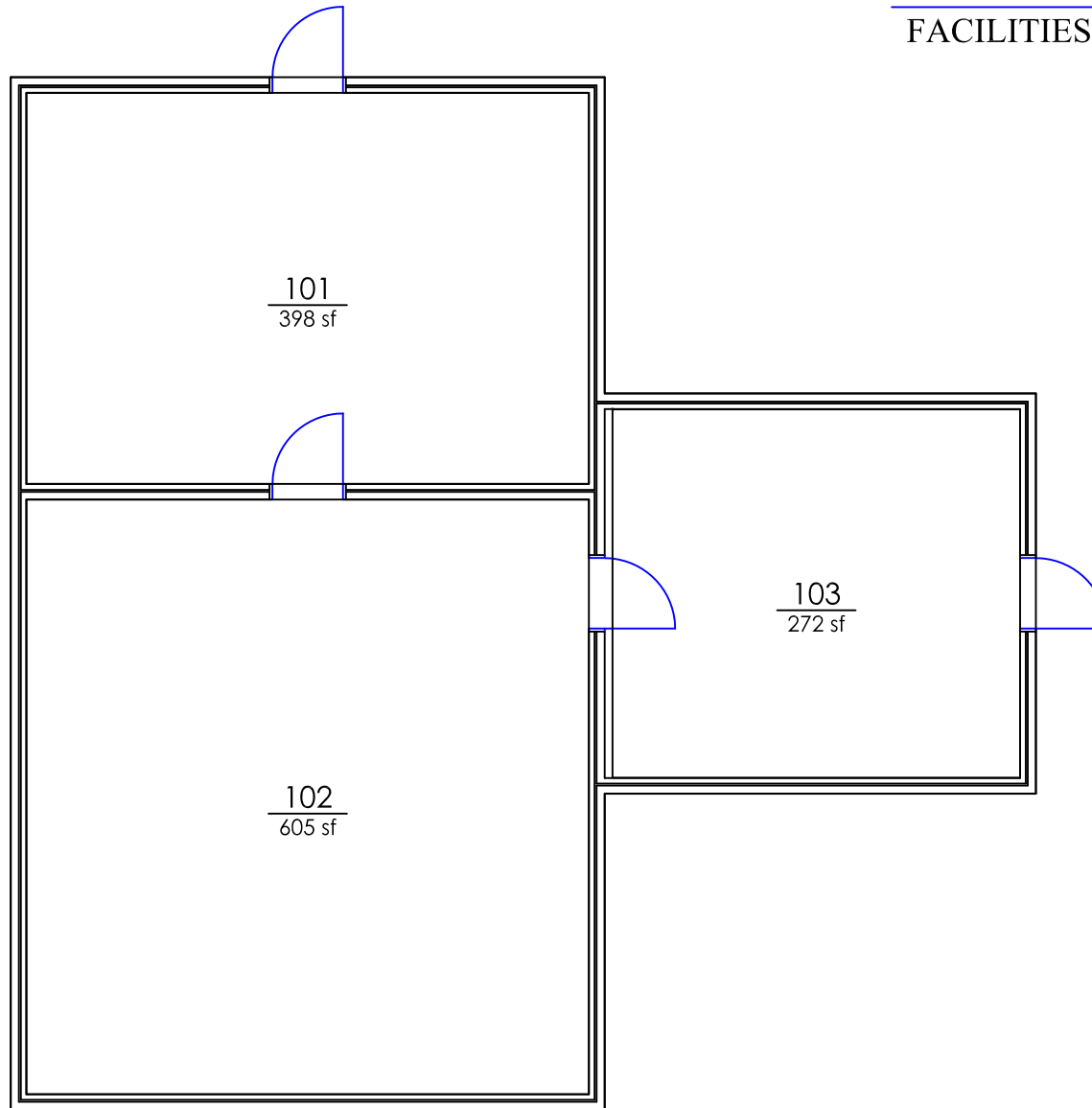
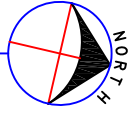
FLOOR PLAN
FACILITIES GREENHOUSE





 FICM Code 210 Classroom
 FICM Code 110 Classroom

 = FIRE EXTINGUISHER  = AED  = FIRE DEP. CONNECTION  = LOCK BOX  = FIRE ALARM CONTROL PANEL  = SPRINKLER HEADER **R** = SPRINKLER RISER  = Bottle Filler

DATE REVISED 10/14/2020	ADDRESS 1320 Woodward LN	Square Feet 1421	BLDG NO 1425	(GRN) GREENHOUSE #1 FLOOR PLAN	FLOOR 1
----------------------------	--------------------------------	---------------------	-----------------	-----------------------------------	------------

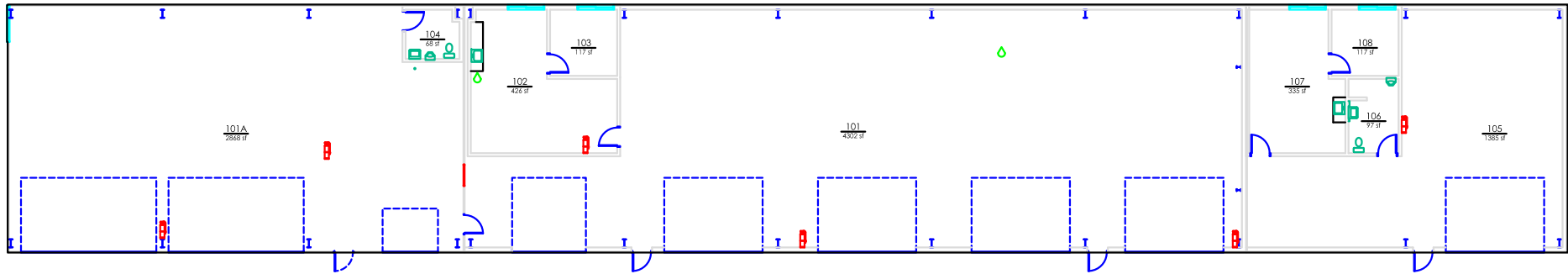
DRAWINGS ARE NOT TO SCALE



-  FICM Code 210 Classroom
-  FICM Code 110 Classroom



-  = FIRE EXTINGUISHER
-  = AED
-  = FIRE DEP. CONNECTION
-  = LOCK BOX
-  = FIRE ALARM CONTROL PANEL
-  = SPRINKLER HEADER
-  = SPRINKLER RISER
-  = Bottle Filler

DATE REVISED	ADDRESS	Square Feet	BLDG NO	(GSB) GROUND STORAGE BUILDING FIRST FLOOR	FLOOR
02/01/2022	1320 Woodward LN	10239	1415		1

DRAWINGS ARE NOT TO SCALE

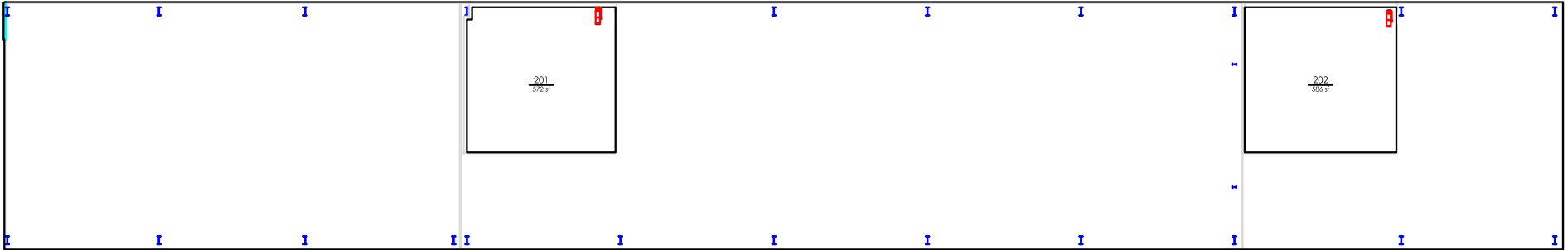
SECOND FLOOR
INDUSTRIAL AREA BUILDING



 FICM Code 210 Classroom
 FICM Code 110 Classroom



 = FIRE EXTINGUISHER  = AED  = FIRE DEP. CONNECTION  = LOCK BOX  = FIRE ALARM CONTROL PANEL  = SPRINKLER HEADER **R** = SPRINKLER RISER  = Bottle Filler

DATE REVISED	ADDRESS	Square Feet	BLDG NO	(GSB) GROUND STORAGE BUILDING SECOND FLOOR	FLOOR
02/01/2022	1320 Woodward LN	10239	1415		2

DRAWINGS ARE NOT TO SCALE

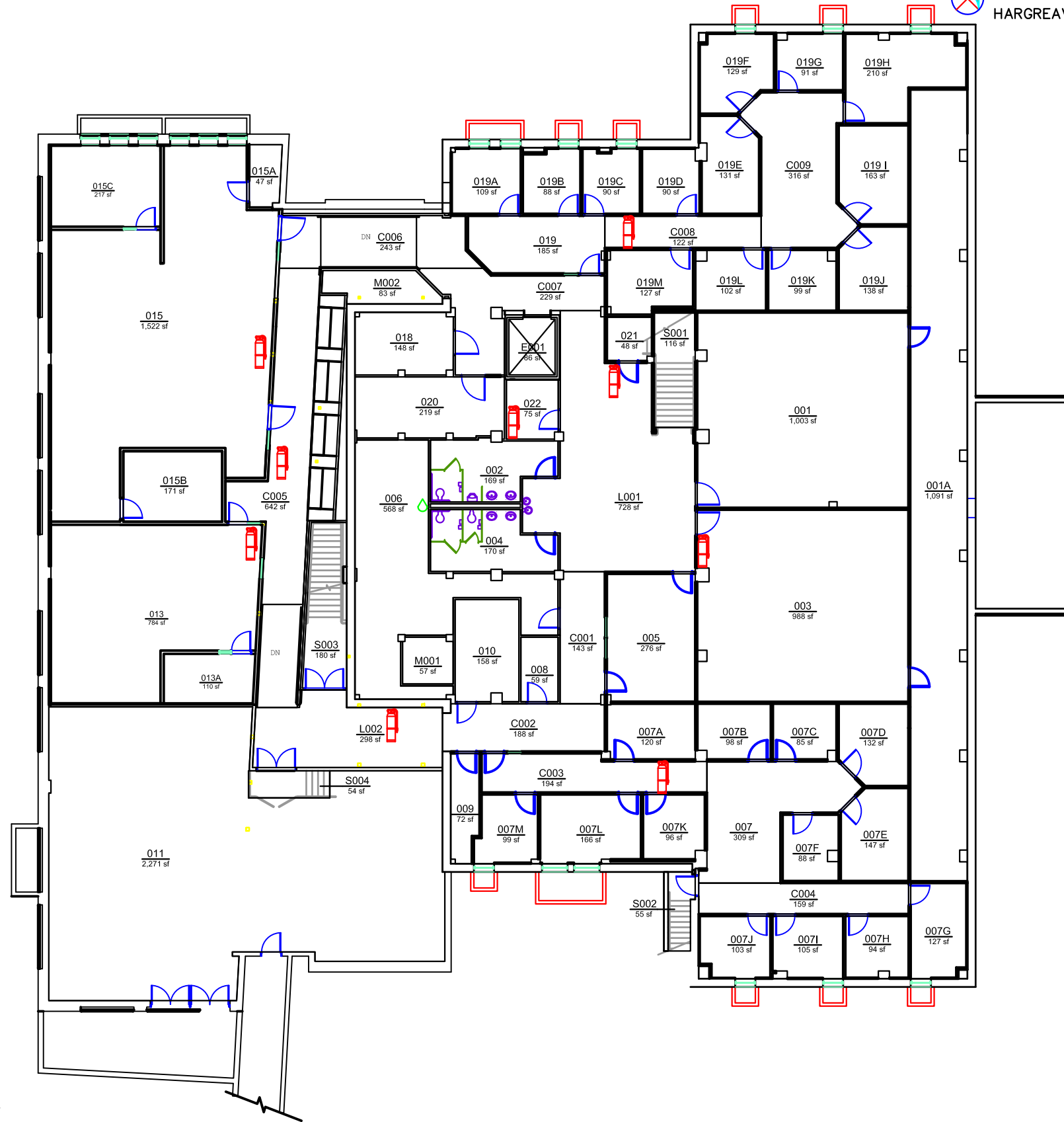
 BASEMENT
HARGREAVES HALL





-  FICM Code 210 Classroom
-  FICM Code 110 Classroom

-  = FIRE EXTINGUISHER
-  = AED
-  = FIRE DEP. CONNECTION
-  = LOCK BOX
-  = FIRE ALARM CONTROL PANEL
-  = SPRINKLER HEADER
-  = SPRINKLER RISER
-  = Bottle Filler

DATE REVISED	ADDRESS	Square Feet	BLDG NO	(HAR) HARGREAVES HALL BASEMENT	FLOOR
02/01/2022	616 Study LN	19483	1181		0

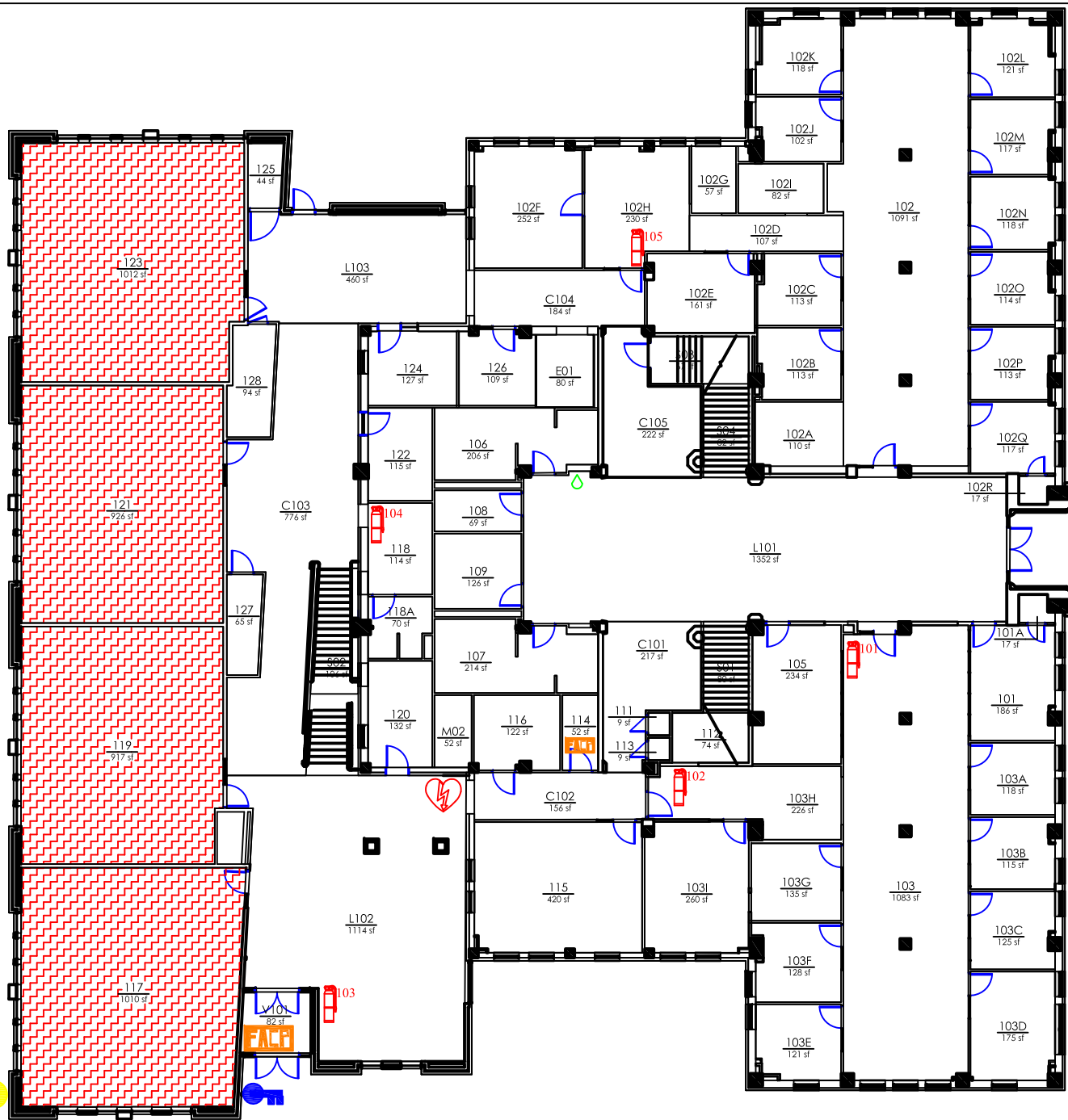
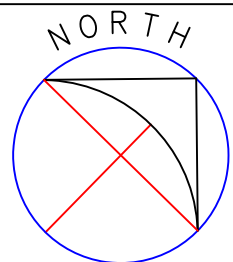
DRAWINGS ARE NOT TO SCALE



 FICM Code 210 Classroom
 FICM Code 110 Classroom

 = FIRE EXTINGUISHER
  = AED
  = FIRE DEP. CONNECTION
  = LOCK BOX
  = FIRE ALARM CONTROL PANEL
  = SPRINKLER HEADER
  = SPRINKLER RISER
  = Bottle Filler

DATE REVISED 07/29/2020	ADDRESS 616 Study LN	Square Feet 19210	BLDG NO 1181	(HAR) HARGREAVES HALL FIRST FLOOR	FLOOR 1
----------------------------	-------------------------	----------------------	-----------------	--------------------------------------	------------

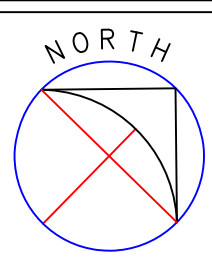



- FICM Code 210 Classroom
- FICM Code 110 Classroom

- = FIRE EXTINGUISHER
- = AED
- = FIRE DEP. CONNECTION
- = LOCK BOX
- = FIRE ALARM CONTROL PANEL
- = SPRINKLER HEADER
- = SPRINKLER RISER
- = Bottle Filler

DATE REVISED	ADDRESS	Square Feet	BLDG NO	(HAR) HARGREAVES HALL SECOND FLOOR	FLOOR 2
07/29/2020	616 Study LN	17923	1181		

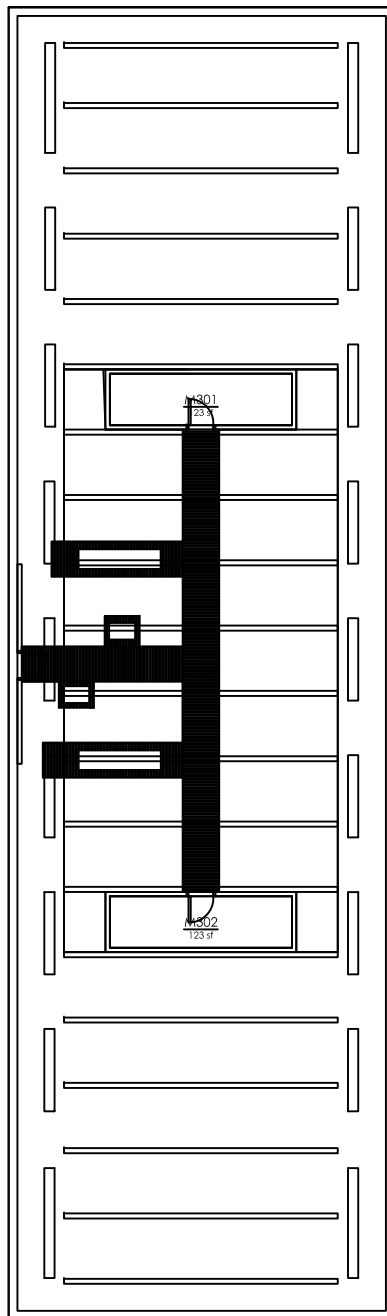
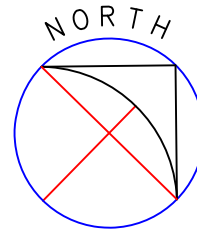
DRAWINGS ARE NOT TO SCALE



 FICM Code 210 Classroom
 FICM Code 110 Classroom

 = FIRE EXTINGUISHER  = AED  = FIRE DEP. CONNECTION  = LOCK BOX  = FIRE ALARM CONTROL PANEL  = SPRINKLER HEADER **R** = SPRINKLER RISER  = Bottle Filler

DATE REVISED
07/29/2020

ADDRESS
616 Study LN

Square Feet

BLDG NO
1181



(HAR) HARGREAVES HALL
THIRD FLOOR

FLOOR
3

DRAWINGS ARE NOT TO SCALE

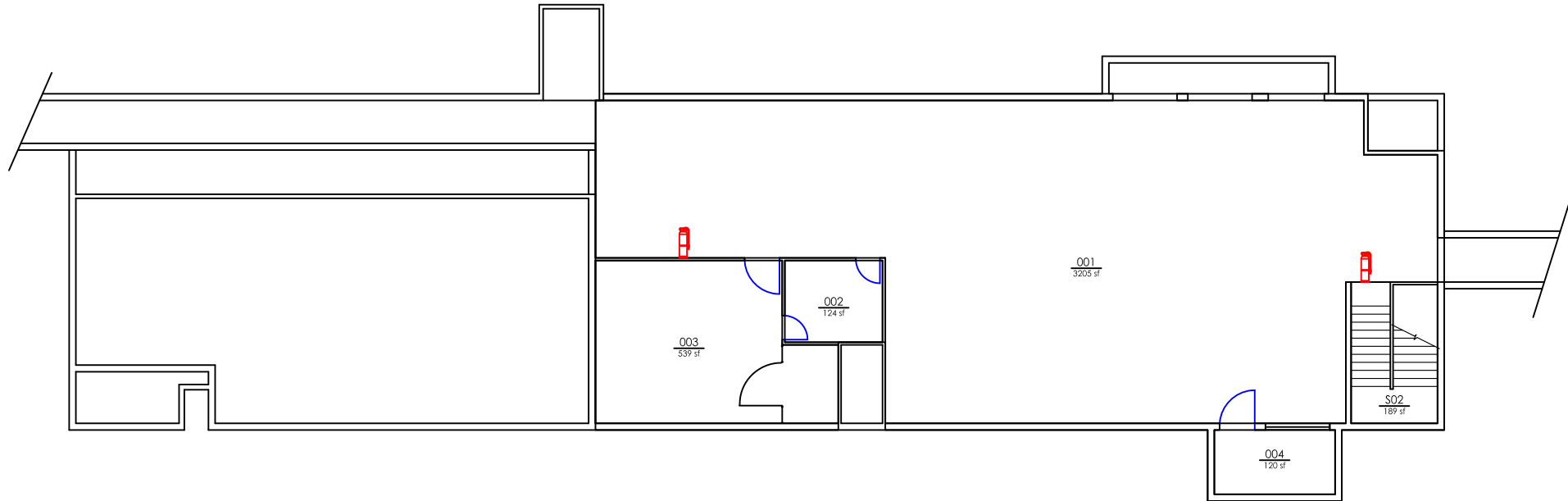
BASEMENT
HUSTON HALL







 FICM Code 210 Classroom
 FICM Code 110 Classroom

 = FIRE EXTINGUISHER  = AED  = FIRE DEP. CONNECTION  = LOCK BOX  = FIRE ALARM CONTROL PANEL  = SPRINKLER HEADER **R** = SPRINKLER RISER  = Bottle Filler

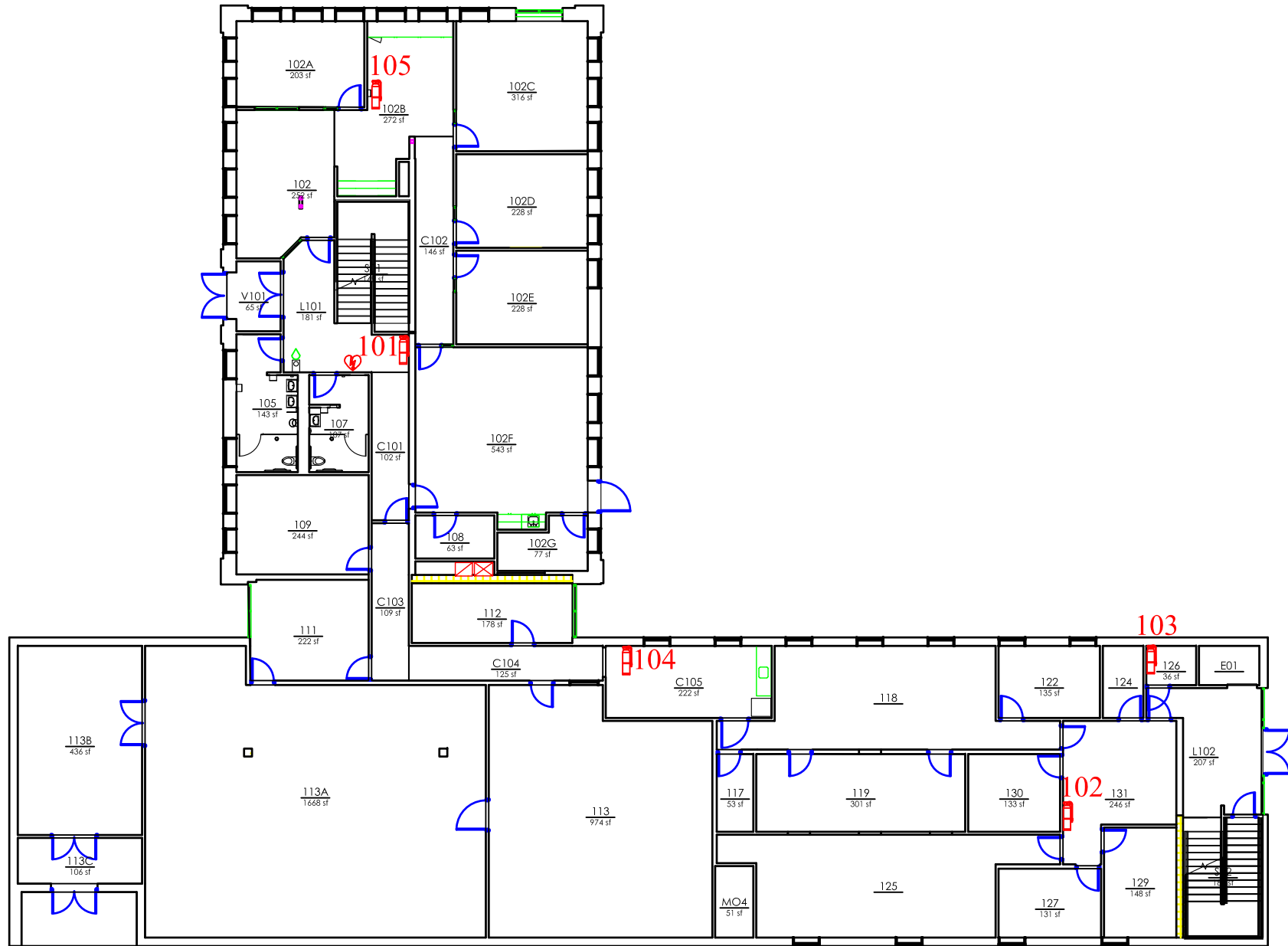
DATE REVISED 10/06/2020	ADDRESS 410 Eagles LN	Square Feet 4436	BLDG NO 1124	(HUS) HUSTON HALL BASEMENT	FLOOR 0
----------------------------	--------------------------	---------------------	-----------------	-------------------------------	------------

DRAWINGS ARE NOT TO SCALE



 FICM Code 210 Classroom
 FICM Code 110 Classroom

 = FIRE EXTINGUISHER  = AED  = FIRE DEP. CONNECTION  = LOCK BOX  = FIRE ALARM CONTROL PANEL  = SPRINKLER HEADER **R** = SPRINKLER RISER  = Bottle Filler

DATE REVISED
10/06/2020

ADDRESS
410 Eagles LN

Square Feet
11439



BLDG NO
1124

(HUS) HUSTON HALL
FIRST FLOOR

FLOOR
1

DRAWINGS ARE NOT TO SCALE



-  FICM Code 210 Classroom
-  FICM Code 110 Classroom

-  = FIRE EXTINGUISHER
-  = AED
-  = FIRE DEP. CONNECTION
-  = LOCK BOX
-  = FIRE ALARM CONTROL PANEL
-  = SPRINKLER HEADER
-  = SPRINKLER RISER
-  = Bottle Filler

DATE REVISED
10/06/2020

ADDRESS
410 Eagles LN

Square Feet
11549

BLDG NO
1124

(HUS) HUSTON HALL
SECOND FLOOR

FLOOR
2

DRAWINGS ARE NOT TO SCALE

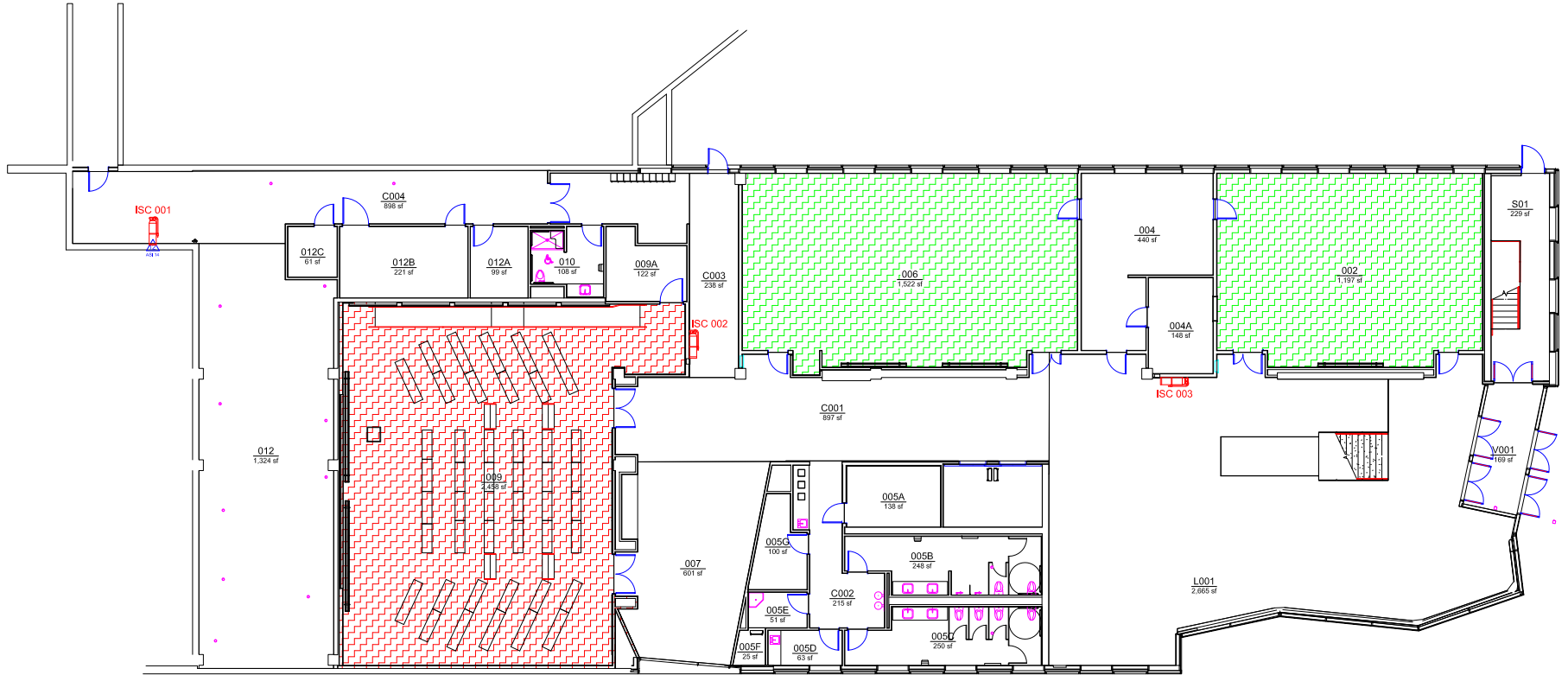

FICM Code 210 Classroom

FICM Code 110 Classroom

= FIRE EXTINGUISHER
 = AED
 = FIRE DEP. CONNECTION
 = LOCK BOX
 = FIRE ALARM CONTROL PANEL
 = SPRINKLER HEADER
 = SPRINKLER RISER
 = Bottle Filler

DATE REVISED
02/01/2022

ADDRESS
405 FRESHMAN LN

Square Feet
15981

BLDG NO
1167

(ISC) INTERDISCIPLINARY SCIENCE CENTER
GROUND FLOOR

FLOOR
0

DRAWINGS ARE NOT TO SCALE



FICM Code 210 Classroom
 FICM Code 110 Classroom

= FIRE EXTINGUISHER = AED = FIRE DEP. CONNECTION = LOCK BOX = FIRE ALARM CONTROL PANEL = SPRINKLER HEADER **R** = SPRINKLER RISER = Bottle Filler

DATE REVISED 02/01/2022	ADDRESS 405 FRESHMAN LN	Square Feet 24078	BLDG NO 1167	(ISC) INTERDISCIPLINARY SCIENCE CENTER FIRST FLOOR	FLOOR 1
----------------------------	----------------------------	----------------------	-----------------	---	------------

DRAWINGS ARE NOT TO SCALE



 FICM Code 210 Classroom

 FICM Code 110 Classroom

 = FIRE EXTINGUISHER
  = AED
  = FIRE DEP. CONNECTION
  = LOCK BOX
  = FIRE ALARM CONTROL PANEL
  = SPRINKLER HEADER
  = SPRINKLER RISER
  = Bottle Filler

DATE REVISED
02/01/2022

ADDRESS
405 FRESHMAN LN

Square Feet
24910



BLDG NO
1167

(ISC) INTERDISCIPLINARY SCIENCE CENTER
SECOND FLOOR

FLOOR
2

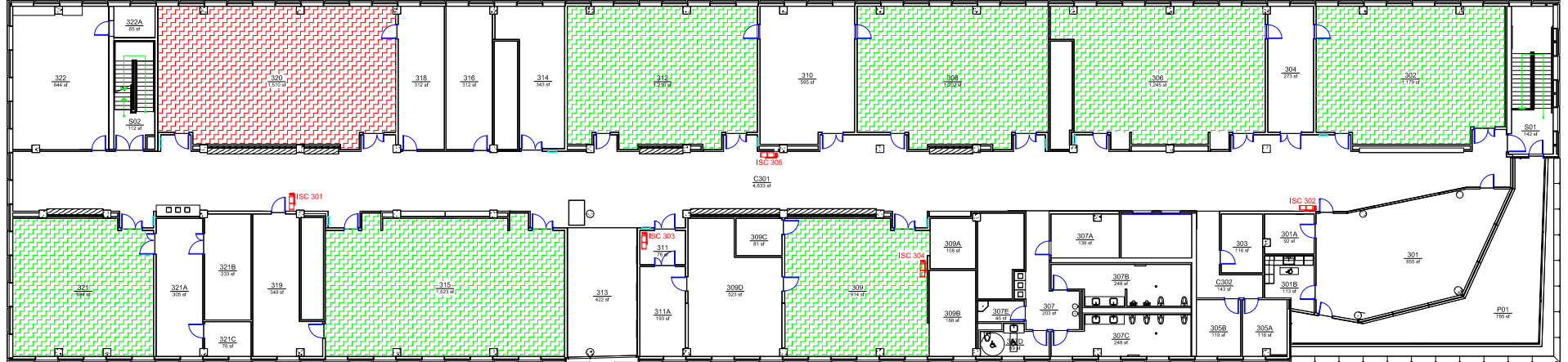
DRAWINGS ARE NOT TO SCALE



 FICM Code 210 Classroom
 FICM Code 110 Classroom

 = FIRE EXTINGUISHER  = AED  = FIRE DEP. CONNECTION  = LOCK BOX  = FIRE ALARM CONTROL PANEL  = SPRINKLER HEADER  = SPRINKLER RISER  = Bottle Filler

DATE REVISED
02/01/2022

ADDRESS
405 FRESHMAN LN

Square Feet
25702

BLDG NO
1167

(ISC) INTERDISCIPLINARY SCIENCE CENTER
THIRD FLOOR

FLOOR
3

DRAWINGS ARE NOT TO SCALE

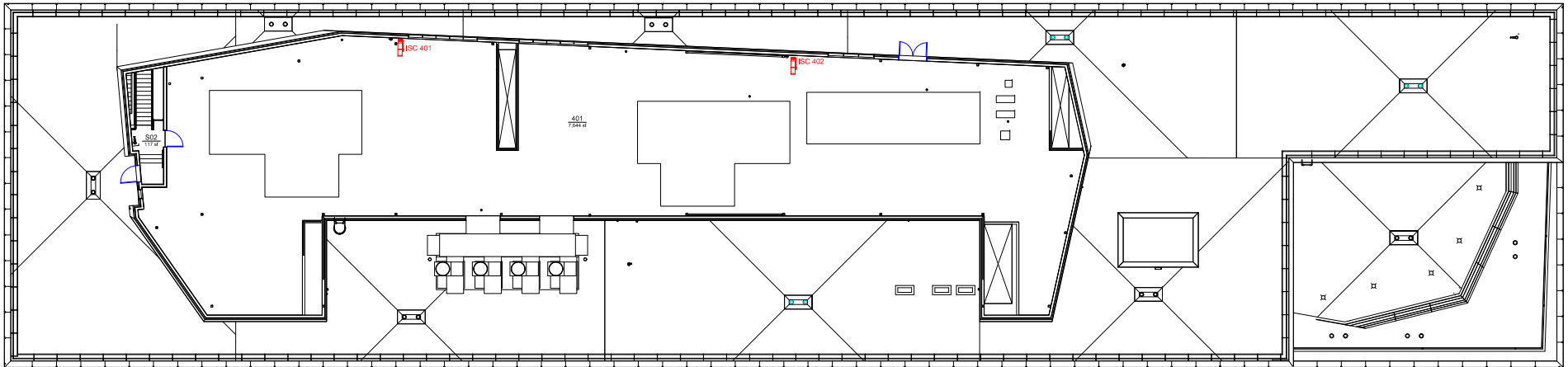

 FICM Code 210 Classroom

 FICM Code 110 Classroom

 = FIRE EXTINGUISHER
  = AED
  = FIRE DEP. CONNECTION
  = LOCK BOX
  = FIRE ALARM CONTROL PANEL
  = SPRINKLER HEADER
  = SPRINKLER RISER
  = Bottle Filler

DATE REVISED
02/01/2022

ADDRESS
405 FRESHMAN LN

Square Feet
8631

BLDG NO
1167

(ISC) INTERDISCIPLINARY SCIENCE CENTER
PENTHOUSE

FLOOR
4

DRAWINGS ARE NOT TO SCALE

FIRST FLOOR
ISLE HALL

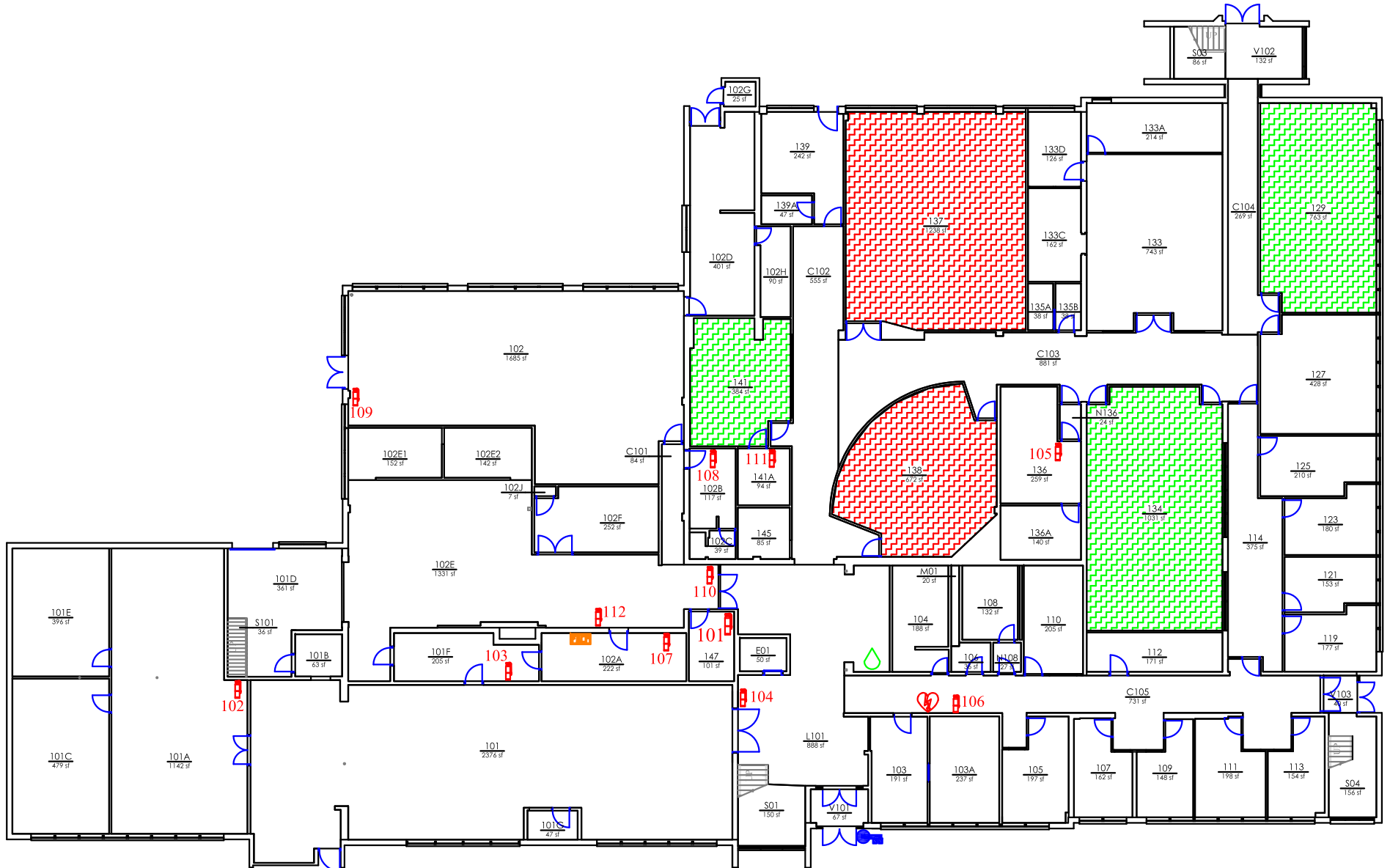

- FICM Code 210 Classroom
- FICM Code 110 Classroom



- = FIRE EXTINGUISHER
- = AED
- = FIRE DEP. CONNECTION
- = LOCK BOX
- = FIRE ALARM CONTROL PANEL
- = SPRINKLER HEADER
- = SPRINKLER RISER
- = Bottle Filler

DATE REVISED	ADDRESS	Square Feet	BLDG NO	(ISL) ISLE HALL FIRST FLOOR	FLOOR
02/01/2022	616 Quad LN	25913	1178		1

DRAWINGS ARE NOT TO SCALE

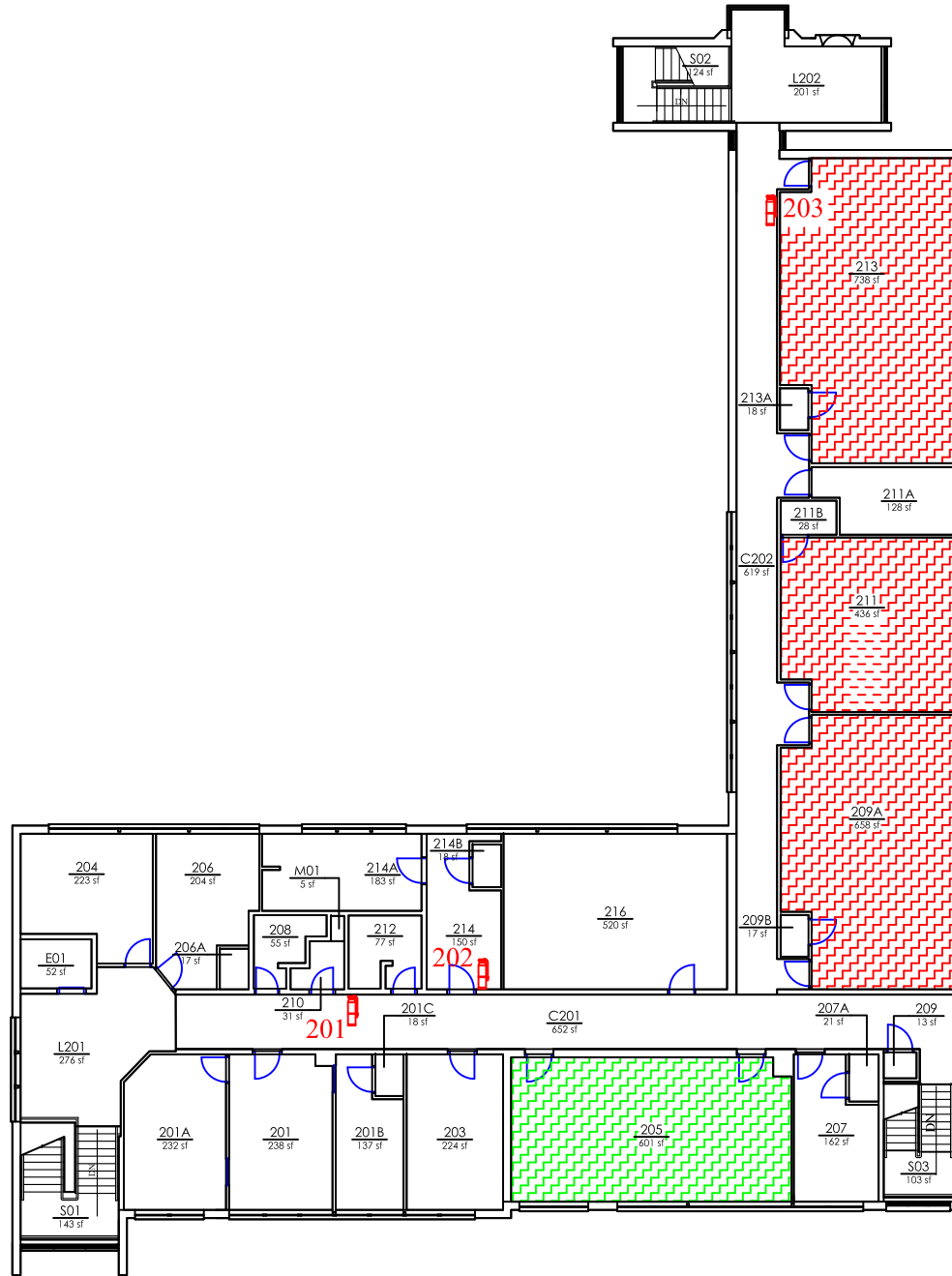
SECOND FLOOR
ISLE HALL





-  FICM Code 210 Classroom
-  FICM Code 110 Classroom

-  = FIRE EXTINGUISHER
-  = AED
-  = FIRE DEP. CONNECTION
-  = LOCK BOX
-  = FIRE ALARM CONTROL PANEL
-  = SPRINKLER HEADER
- R** = SPRINKLER RISER
-  = Bottle Filler

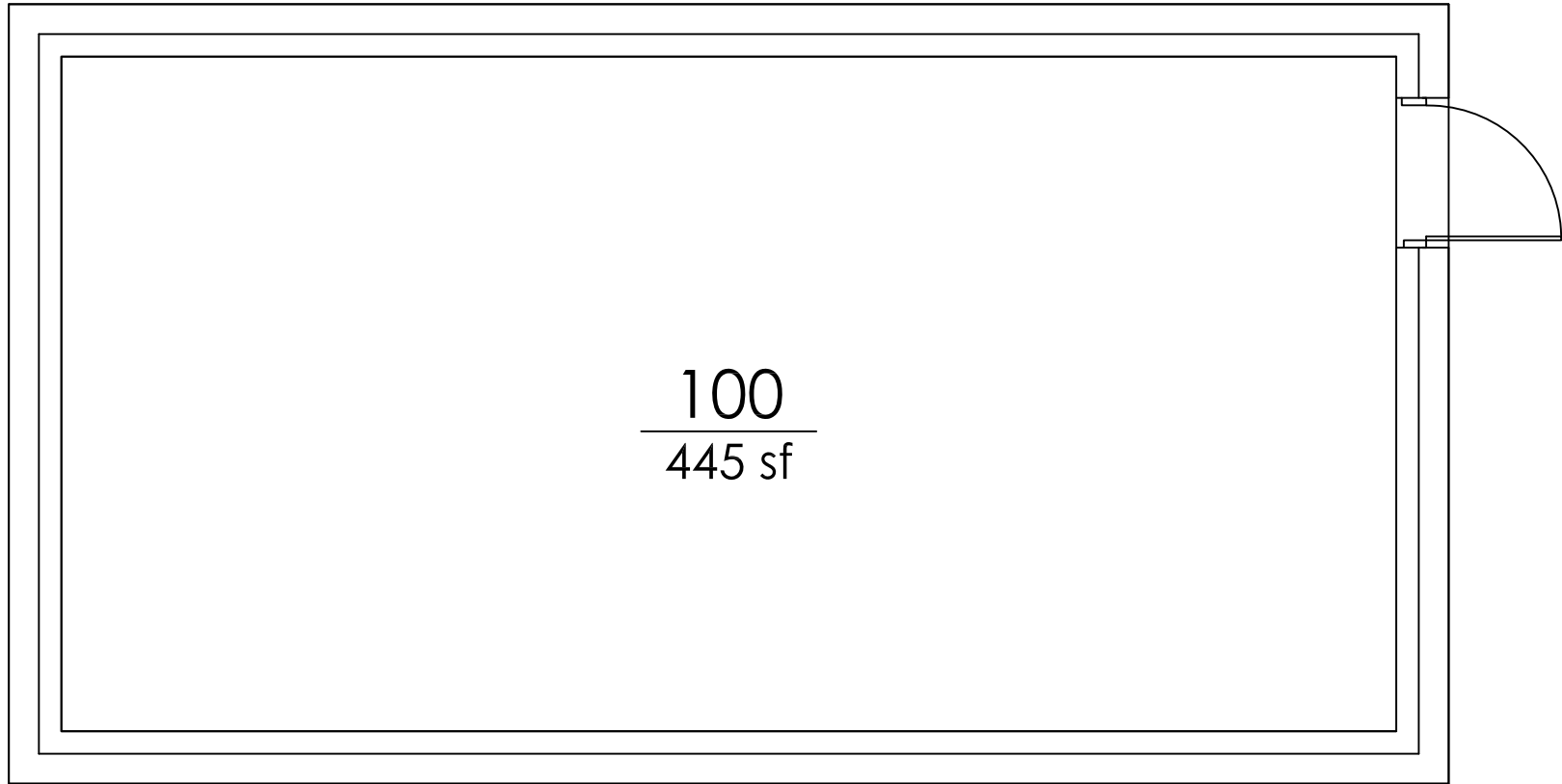
DATE REVISED	ADDRESS	Square Feet	BLDG NO	(ISL) ISLE HALL SECOND FLOOR	FLOOR 2
09/14/2020	616 Quad LN	8409	1178		



 FICM Code 210 Classroom
 FICM Code 110 Classroom



 = FIRE EXTINGUISHER  = AED  = FIRE DEP. CONNECTION  = LOCK BOX  = FIRE ALARM CONTROL PANEL  = SPRINKLER HEADER **R** = SPRINKLER RISER  = Bottle Filler

DATE REVISED 10/15/2020	ADDRESS 116 N. 11th ST	Square Feet 10/15/2020	BLDG NO 1712	(ITB) INTERTIE BUILDING	FLOOR 1
----------------------------	---------------------------	---------------------------	-----------------	-------------------------	------------

DRAWINGS ARE NOT TO SCALE

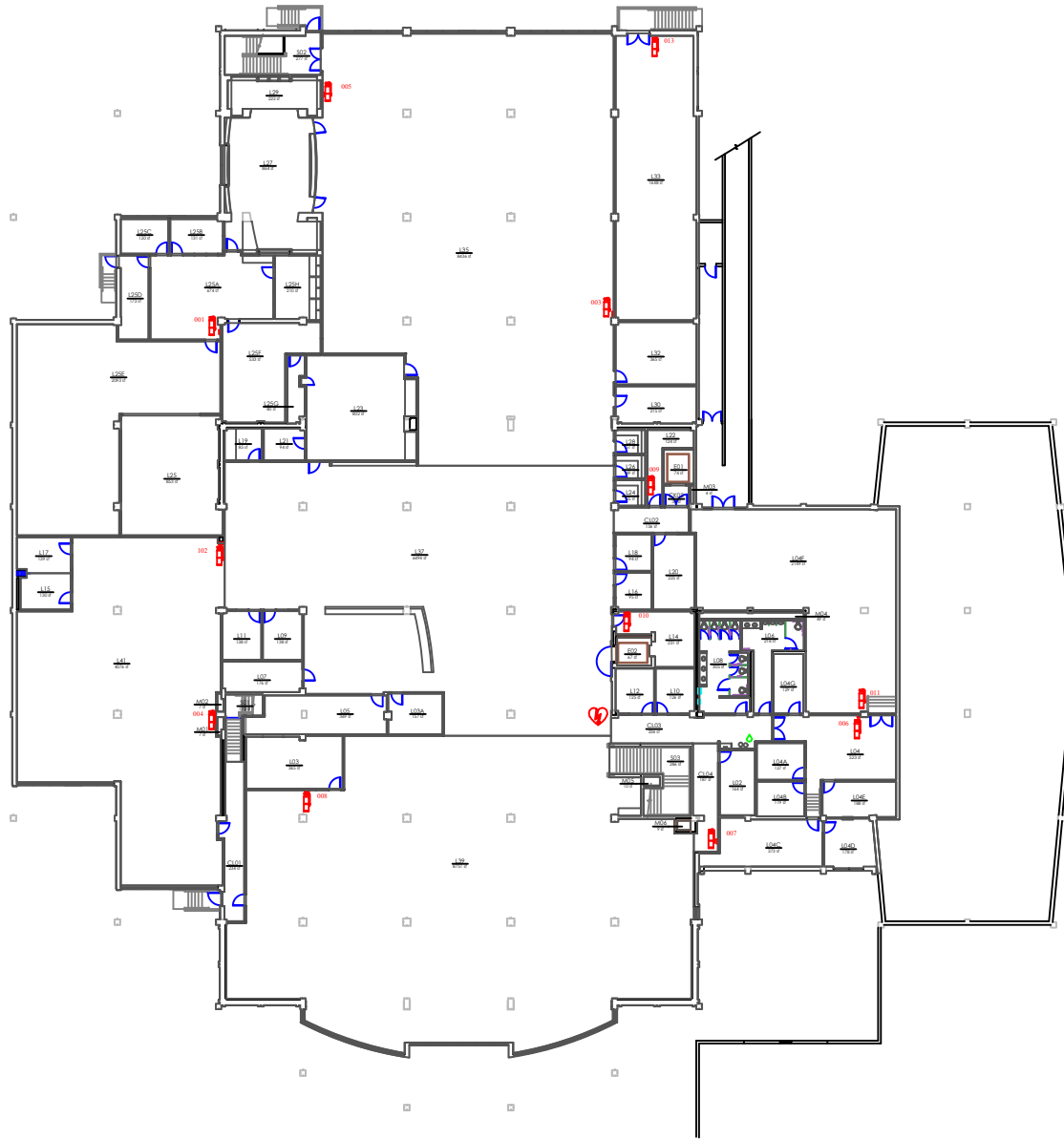
LOWER LEVEL
JFK LIBRARY

 FICM Code 210 Classroom
 FICM Code 110 Classroom



 = FIRE EXTINGUISHER  = AED  = FIRE DEP. CONNECTION  = LOCK BOX  = FIRE ALARM CONTROL PANEL  = SPRINKLER HEADER **R** = SPRINKLER RISER  = Bottle Filler

DATE REVISED 02/01/2022	ADDRESS 320 Media LN	Square Feet 48603	BLDG NO 1169	(JFK) JFK LIBRARY LOWER LEVER	FLOOR 0
----------------------------	-------------------------	----------------------	-----------------	----------------------------------	------------

DRAWINGS ARE NOT TO SCALE

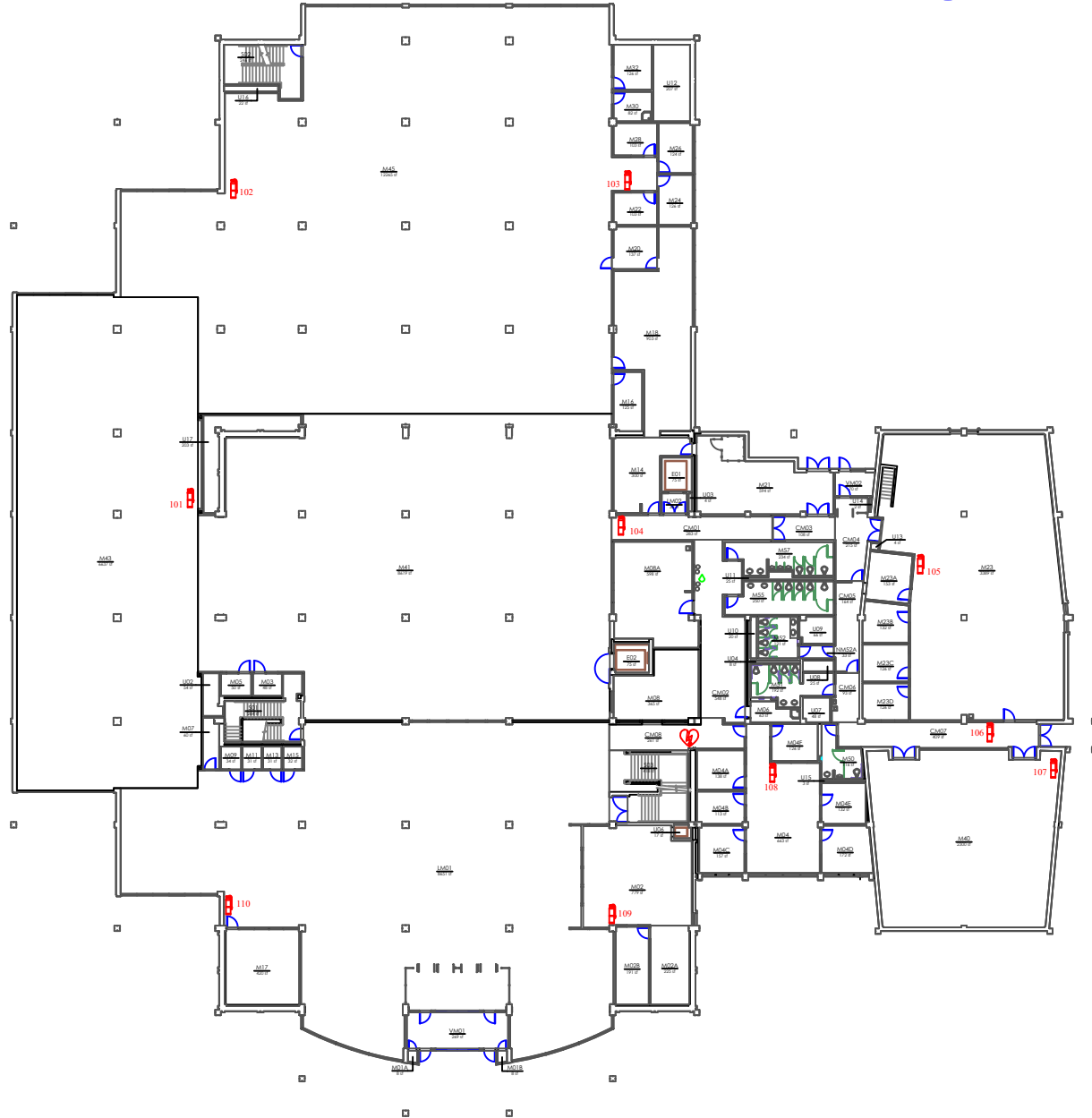
MAIN FLOOR
JFK LIBRARY

 FICM Code 210 Classroom
 FICM Code 110 Classroom

 = FIRE EXTINGUISHER  = AED  = FIRE DEP. CONNECTION  = LOCK BOX  = FIRE ALARM CONTROL PANEL  = SPRINKLER HEADER **R** = SPRINKLER RISER  = Bottle Filler

DATE REVISED
02/01/2022

ADDRESS
320 Media LN

Square Feet
56968



BLDG NO
1169

(JFK) JFK LIBRARY
FIRST FLOOR

FLOOR
1

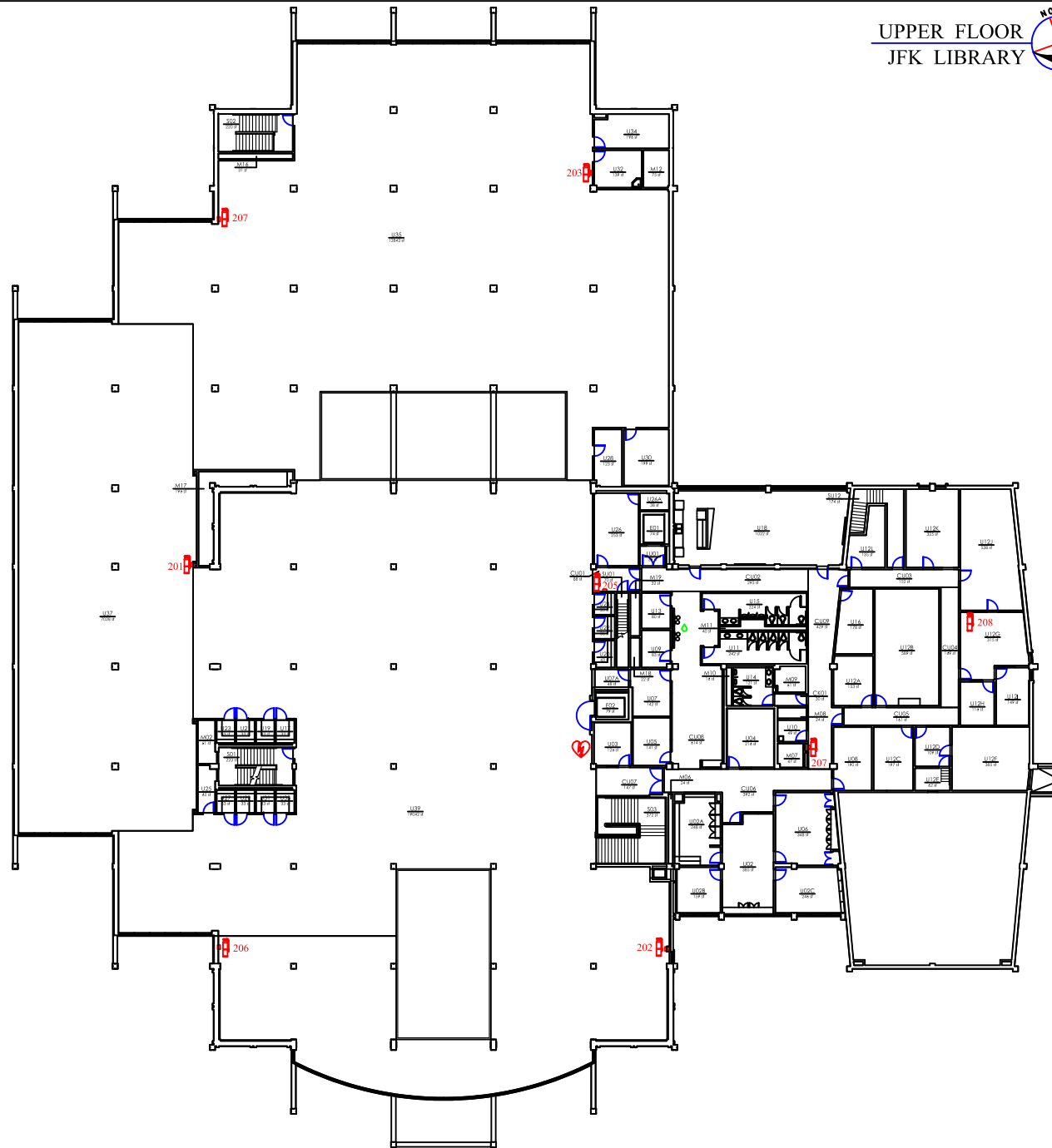
DRAWINGS ARE NOT TO SCALE



 FICM Code 210 Classroom
 FICM Code 110 Classroom

 = FIRE EXTINGUISHER  = AED  = FIRE DEP. CONNECTION  = LOCK BOX  = FIRE ALARM CONTROL PANEL  = SPRINKLER HEADER  = SPRINKLER RISER  = Bottle Filler

DATE REVISED
07/29/20

ADDRESS
320 Media LN

Square Feet
53850

BLDG NO
1169

(JFK) JFK LIBRARY
SECOND FLOOR

FLOOR
2

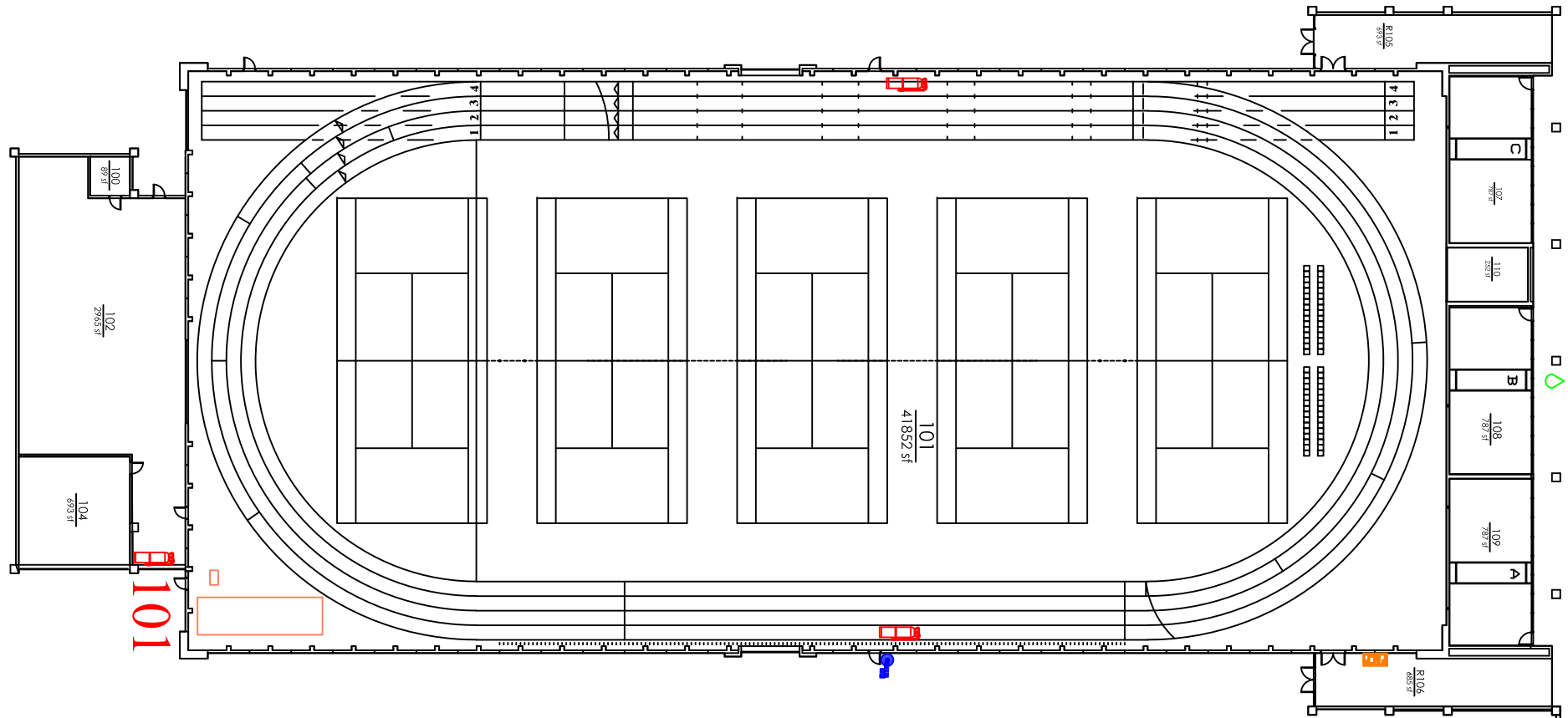

FICM Code 210 Classroom
 FICM Code 110 Classroom

= FIRE EXTINGUISHER = AED = FIRE DEP. CONNECTION = LOCK BOX = FIRE ALARM CONTROL PANEL = SPRINKLER HEADER **R** = SPRINKLER RISER = Bottle Filler

DATE REVISED
10/15/2020

ADDRESS
1380 Athletics LN



Square Feet
50957

BLDG NO
1335

(JTF) JIM THORPE FIELD HOUSE
FIRST FLOOR

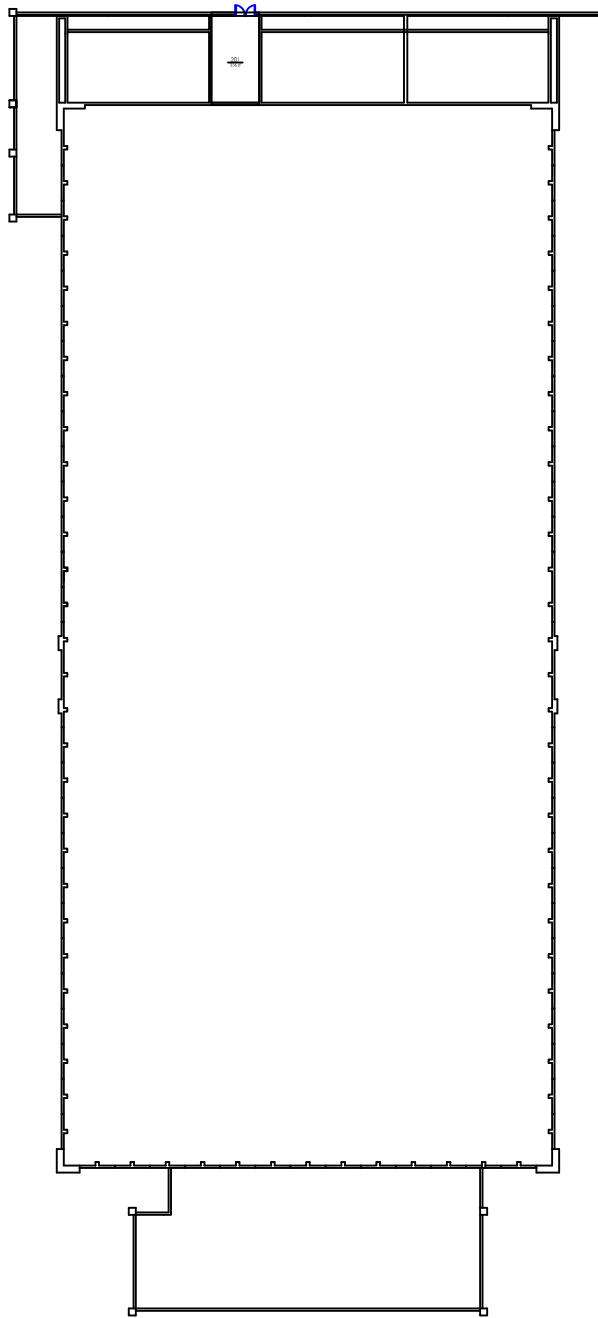
FLOOR
1





 FICM Code 210 Classroom
 FICM Code 110 Classroom

 = FIRE EXTINGUISHER  = AED  = FIRE DEP. CONNECTION  = LOCK BOX  = FIRE ALARM CONTROL PANEL  = SPRINKLER HEADER **R** = SPRINKLER RISER  = Bottle Filler

DATE REVISED 10/15/2020	ADDRESS 1380 Athletics LN	Square Feet 359	BLDG NO 1335	(JTF) JIM THORPE FIELD HOUSE SECOND FLOOR	FLOOR 2
----------------------------	------------------------------	--------------------	-----------------	--	------------

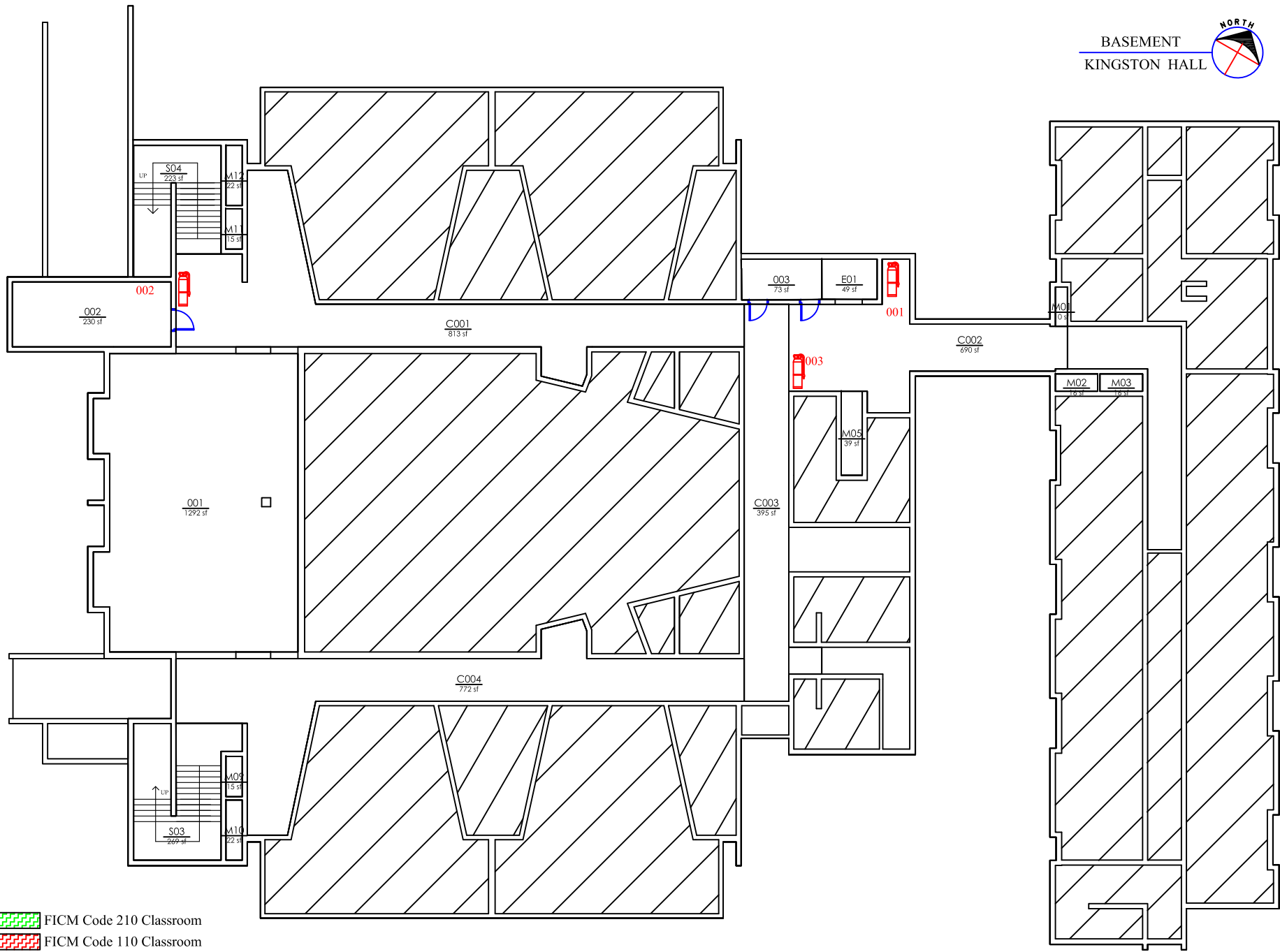
DRAWINGS ARE NOT TO SCALE



 FICM Code 210 Classroom
 FICM Code 110 Classroom

 = FIRE EXTINGUISHER  = AED  = FIRE DEP. CONNECTION  = LOCK BOX  = FIRE ALARM CONTROL PANEL  = SPRINKLER HEADER **R** = SPRINKLER RISER  = Bottle Filler

DATE REVISED
07/30/20

ADDRESS
510 C Street

Square Feet
17492

BLDG NO
1190

(KGS) KINGSTON HALL
BASEMENT

FLOOR
0

DRAWINGS ARE NOT TO SCALE

FIRST FLOOR
KINGSTON HALL

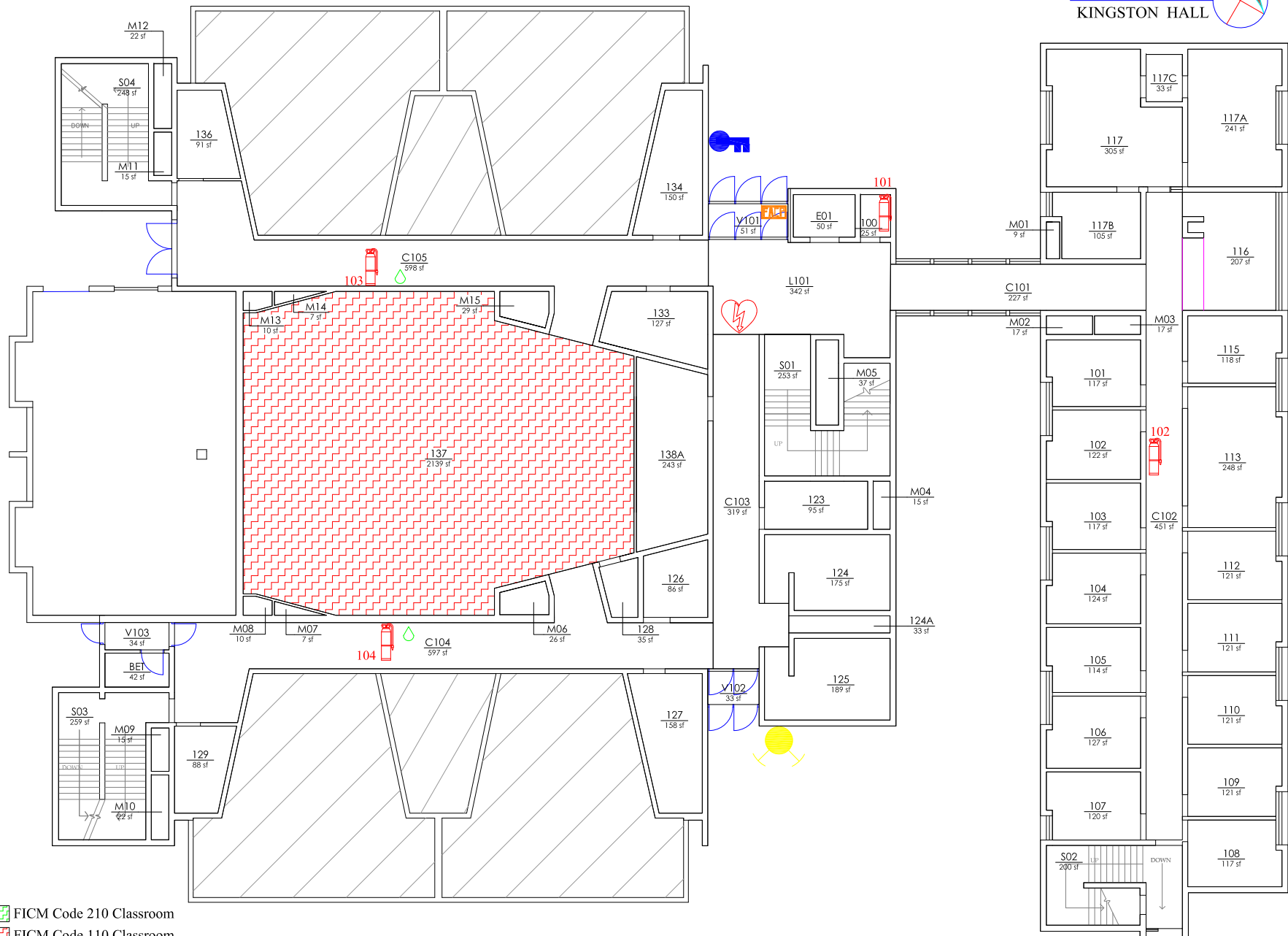

FICM Code 210 Classroom
 FICM Code 110 Classroom

= FIRE EXTINGUISHER = AED = FIRE DEP. CONNECTION = LOCK BOX = FIRE ALARM CONTROL PANEL = SPRINKLER HEADER = SPRINKLER RISER = Bottle Filler

DATE REVISED 02/01/2022	ADDRESS 510 C Street	Square Feet 11859	BLDG NO 1190	(KGS) KINGSTON HALL FIRST FLOOR	FLOOR 1
----------------------------	-------------------------	----------------------	-----------------	------------------------------------	------------

DRAWINGS ARE NOT TO SCALE

SECOND FLOOR
KINGSTON HALL

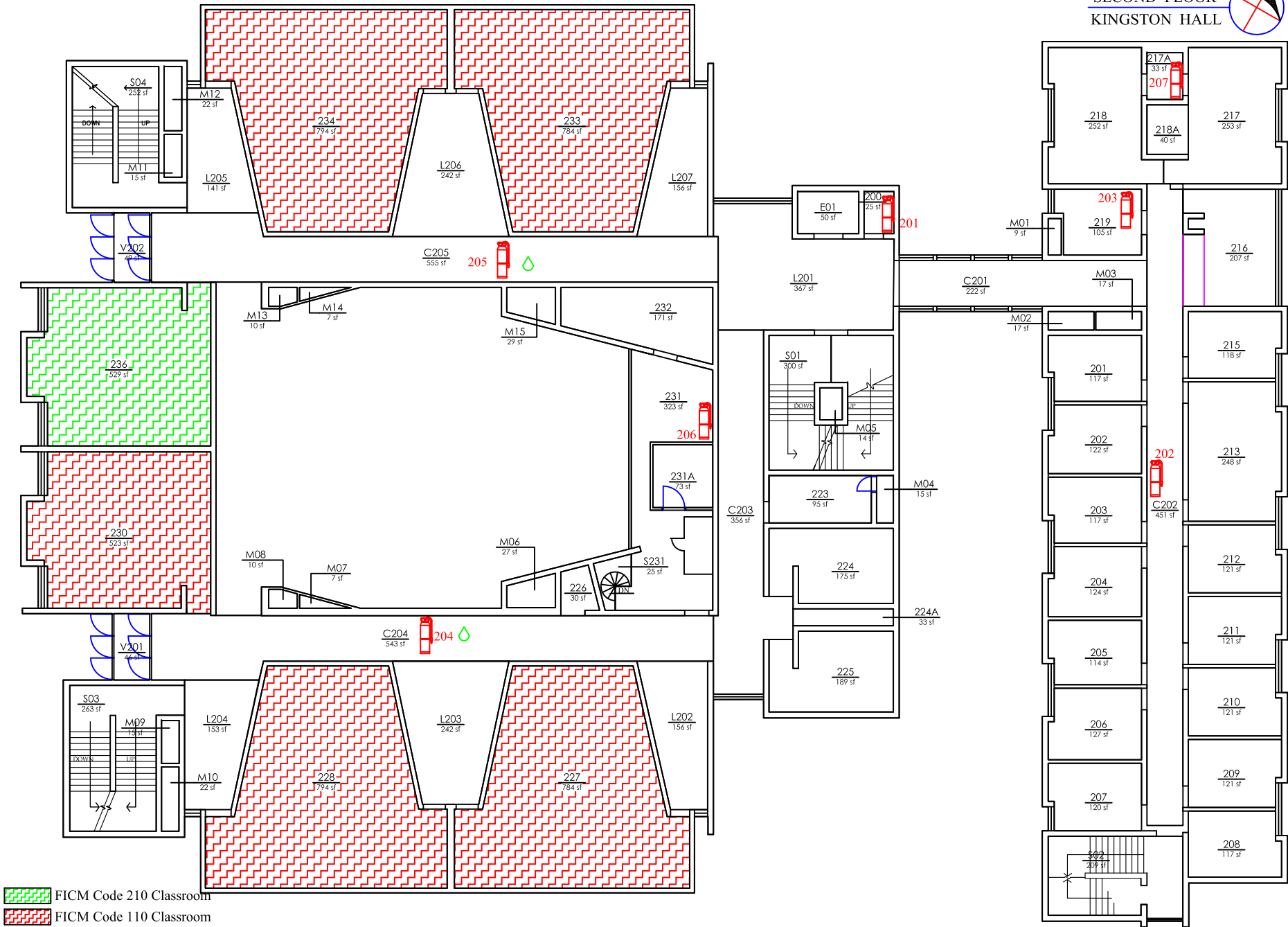

FICM Code 210 Classroom
 FICM Code 110 Classroom

= FIRE EXTINGUISHER = AED = FIRE DEP. CONNECTION = LOCK BOX = FIRE ALARM CONTROL PANEL = SPRINKLER HEADER **R** = SPRINKLER RISER = Bottle Filler

DATE REVISED 07/30/2020	ADDRESS 510 C Street	Square Feet 14742	BLDG NO 1190	(KGS) KINGSTON HALL SECOND FLOOR	FLOOR 2
----------------------------	-------------------------	----------------------	-----------------	-------------------------------------	------------

DRAWINGS ARE NOT TO SCALE

THIRD FLOOR
KINGSTON HALL



FICM Code 210 Classroom
 FICM Code 110 Classroom

= FIRE EXTINGUISHER = AED = FIRE DEP. CONNECTION = LOCK BOX = FIRE ALARM CONTROL PANEL = SPRINKLER HEADER **R** = SPRINKLER RISER = Bottle Filler

DATE REVISED
02/01/2022

ADDRESS
510 C Street

Square Feet
17182

BLDG NO
1190

(KGS) KINGSTON HALL
THIRD FLOOR

FLOOR
3





FICM Code 210 Classroom
 FICM Code 110 Classroom

= FIRE EXTINGUISHER = AED = FIRE DEP. CONNECTION = LOCK BOX = FIRE ALARM CONTROL PANEL = SPRINKLER HEADER **R** = SPRINKLER RISER = Bottle Filler

DATE REVISED 10/05/2020	ADDRESS 905 Elm Street	Square Feet 26009	BLDG NO 1475	(LAH) LOUISE ANDERSON HALL FIRST FLOOR	FLOOR 1
----------------------------	---------------------------	----------------------	-----------------	---	------------

DRAWINGS ARE NOT TO SCALE



-  FICM Code 210 Classroom
-  FICM Code 110 Classroom

SECOND FLOOR
LOUISE ANDERSON HALL



-  = FIRE EXTINGUISHER
-  = AED
-  = FIRE DEP. CONNECTION
-  = LOCK BOX
-  = FIRE ALARM CONTROL PANEL
-  = SPRINKLER HEADER
- R** = SPRINKLER RISER
-  = Bottle Filler

DATE REVISED
10/05/2020

ADDRESS
905 Elm Street

Square Feet
25617

BLDG NO
1475

(LAH) LOUISE ANDERSON HALL
SECOND FLOOR

FLOOR
2

DRAWINGS ARE NOT TO SCALE

THIRD FLOOR
LOUISE ANDERSON HALL



- FICM Code 210 Classroom
- FICM Code 110 Classroom



- = FIRE EXTINGUISHER
- = AED
- = FIRE DEP. CONNECTION
- = LOCK BOX
- = FIRE ALARM CONTROL PANEL
- = SPRINKLER HEADER
- = SPRINKLER RISER
- = Bottle Filler

DATE REVISED 10/05/2020	ADDRESS 905 Elm Street	Square Feet 20996	BLDG NO 1475	(LAH) LOUISE ANDERSON HALL THIRD FLOOR	FLOOR 3
----------------------------	---------------------------	----------------------	-----------------	---	------------

DRAWINGS ARE NOT TO SCALE

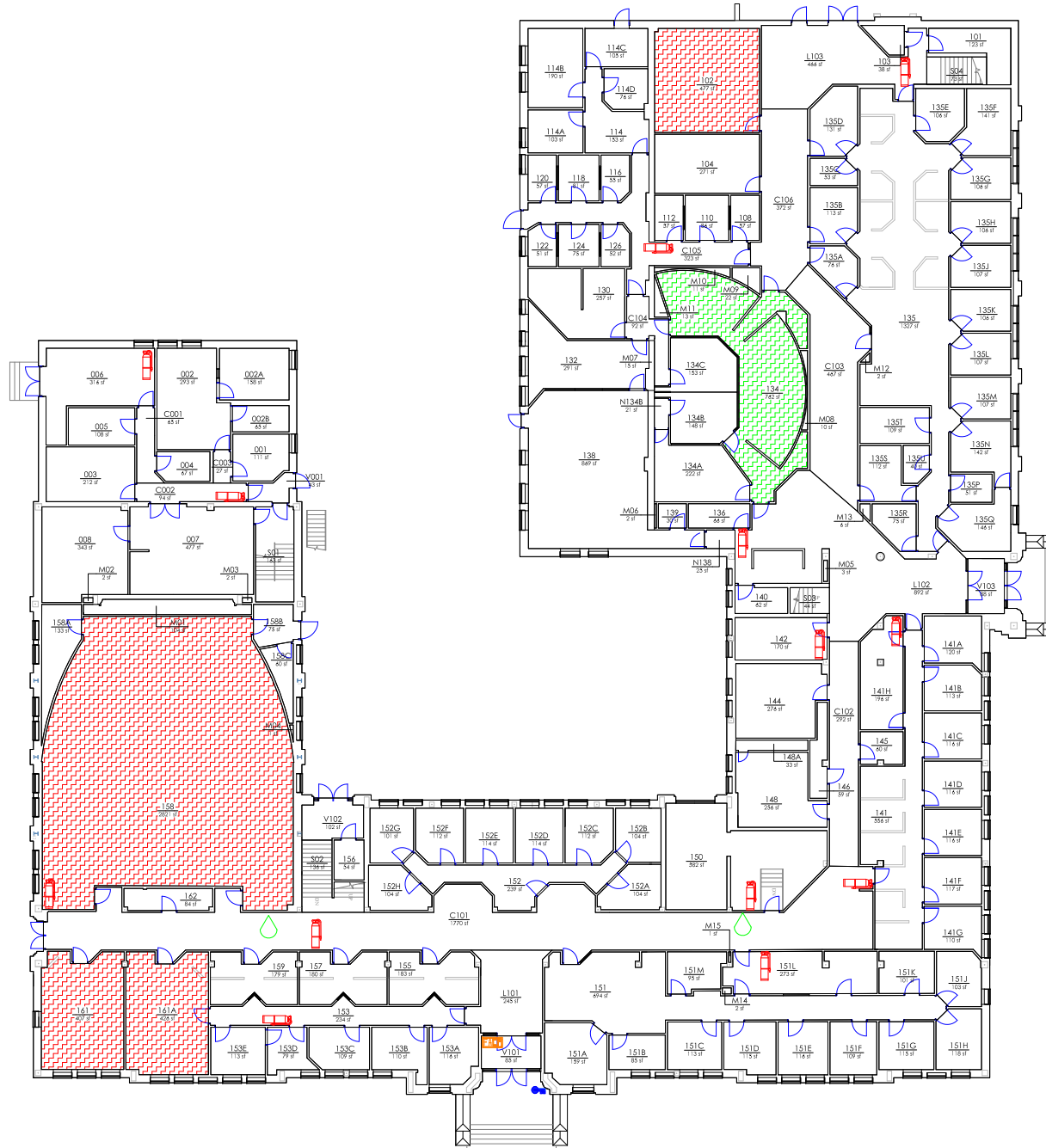
 **FIRST FLOOR**
MARTIN HALL



 FICM Code 210 Classroom
 FICM Code 110 Classroom

 = FIRE EXTINGUISHER  = AED  = FIRE DEP. CONNECTION  = LOCK BOX  = FIRE ALARM CONTROL PANEL  = SPRINKLER HEADER **R** = SPRINKLER RISER  = Bottle Filler

DATE REVISED
02/01/2022

ADDRESS
312 Eagle LN

Square Feet
31717

BLDG NO
1130



(MAR) MARTIN HALL
FIRST FLOOR

FLOOR
1

DRAWINGS ARE NOT TO SCALE

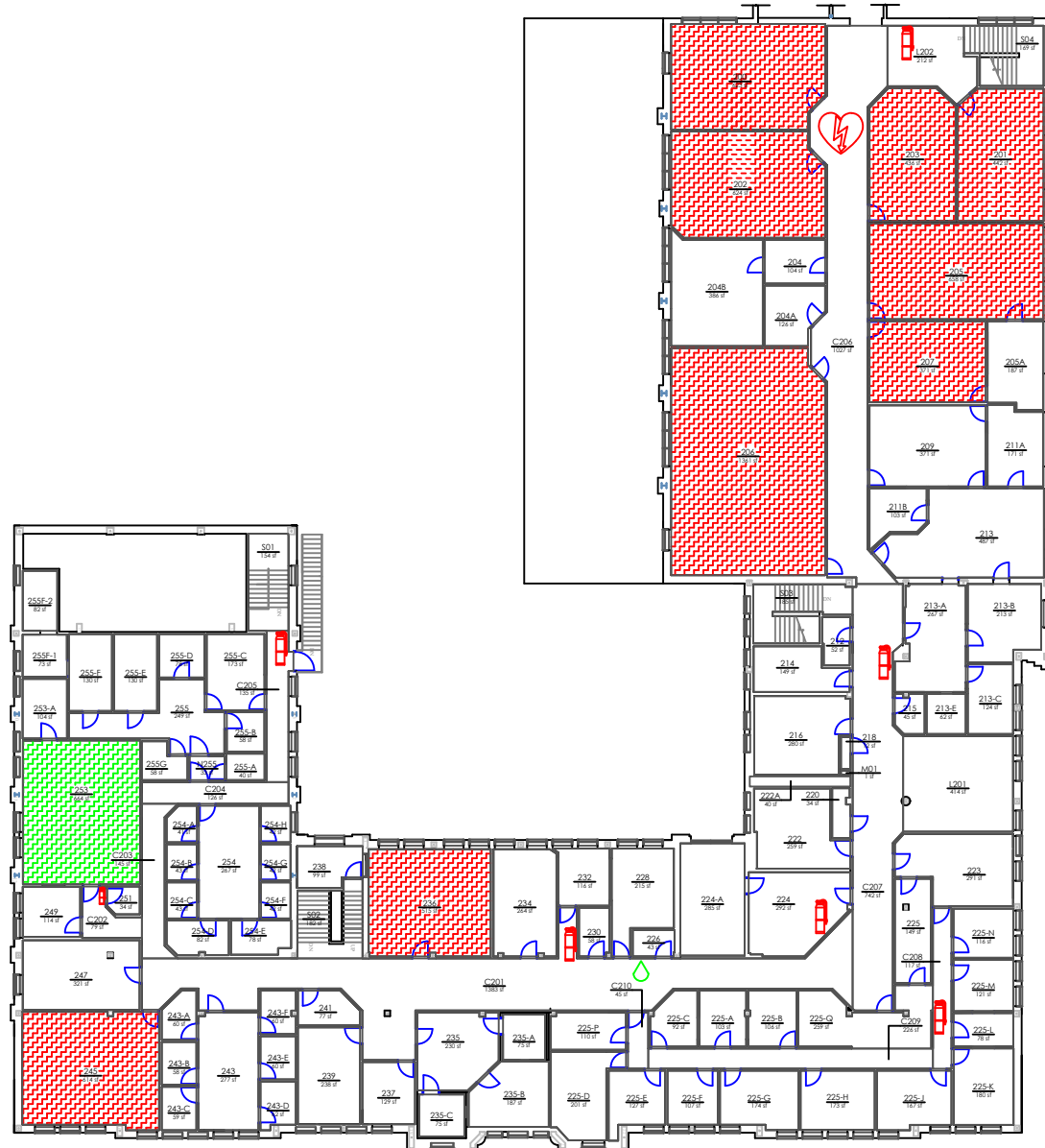
 SECOND FLOOR
MARTIN HALL





 FICM Code 210 Classroom
 FICM Code 110 Classroom

 = FIRE EXTINGUISHER  = AED  = FIRE DEP. CONNECTION  = LOCK BOX  = FIRE ALARM CONTROL PANEL  = SPRINKLER HEADER **R** = SPRINKLER RISER  = Bottle Filler

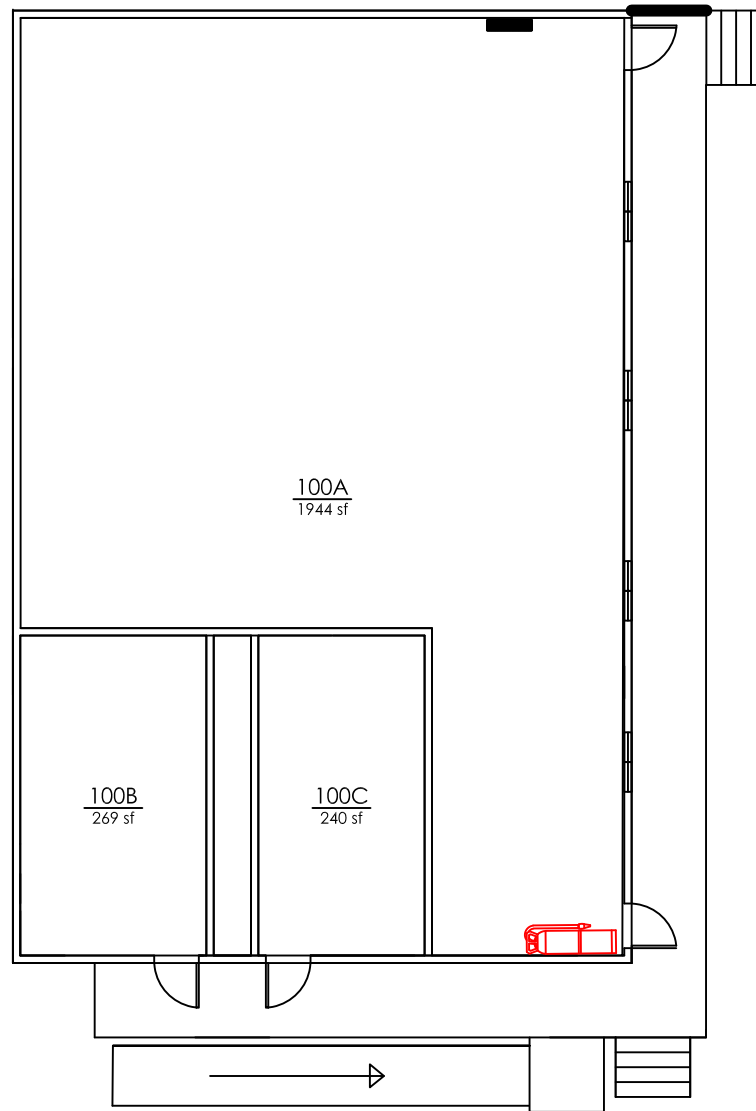
DATE REVISED	ADDRESS	Square Feet	BLDG NO	(MAR) MARTIN HALL SECOND FLOOR	FLOOR
02/01/2022	312 Eagles LN	26076	1130		2



MODULAR BUILDING COMPLEX BUILDING A



-  FICM Code 210 Classroom
-  FICM Code 110 Classroom

-  = FIRE EXTINGUISHER
-  = AED
-  = FIRE DEP. CONNECTION
-  = LOCK BOX
-  = FIRE ALARM CONTROL PANEL
-  = SPRINKLER HEADER
-  = SPRINKLER RISER
-  = Bottle Filler

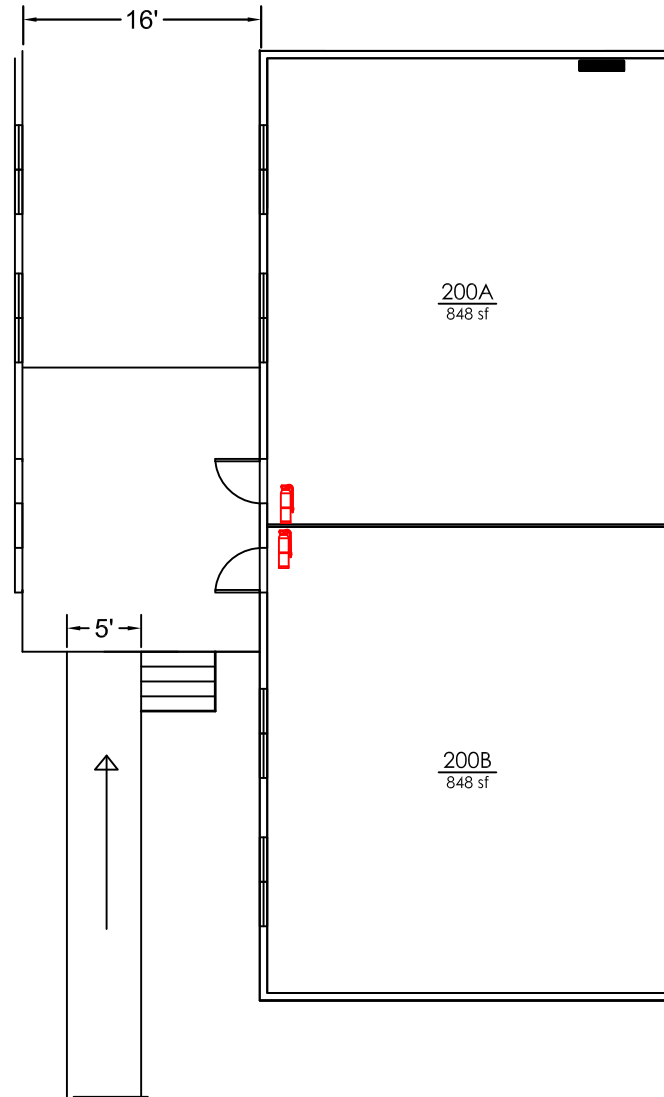
DATE REVISED 10/15/2020	ADDRESS 1255 Athletics LN	Square Feet 2453	BLDG NO 1331	(MBA) MODULAR BUILDING A	FLOOR 1
----------------------------	------------------------------	---------------------	-----------------	--------------------------	------------



MODULAR BUILDING COMPLEX BUILDING B

-  FICM Code 210 Classroom
-  FICM Code 110 Classroom

-  = FIRE EXTINGUISHER
-  = AED
-  = FIRE DEP. CONNECTION
-  = LOCK BOX
-  = FIRE ALARM CONTROL PANEL
-  = SPRINKLER HEADER
-  = SPRINKLER RISER
-  = Bottle Filler

DATE REVISED
10/15/2020

ADDRESS
1225 Athletics
LN

Square Feet
1696



BLDG NO
1332

(MBB) MODULAR BUILDING B

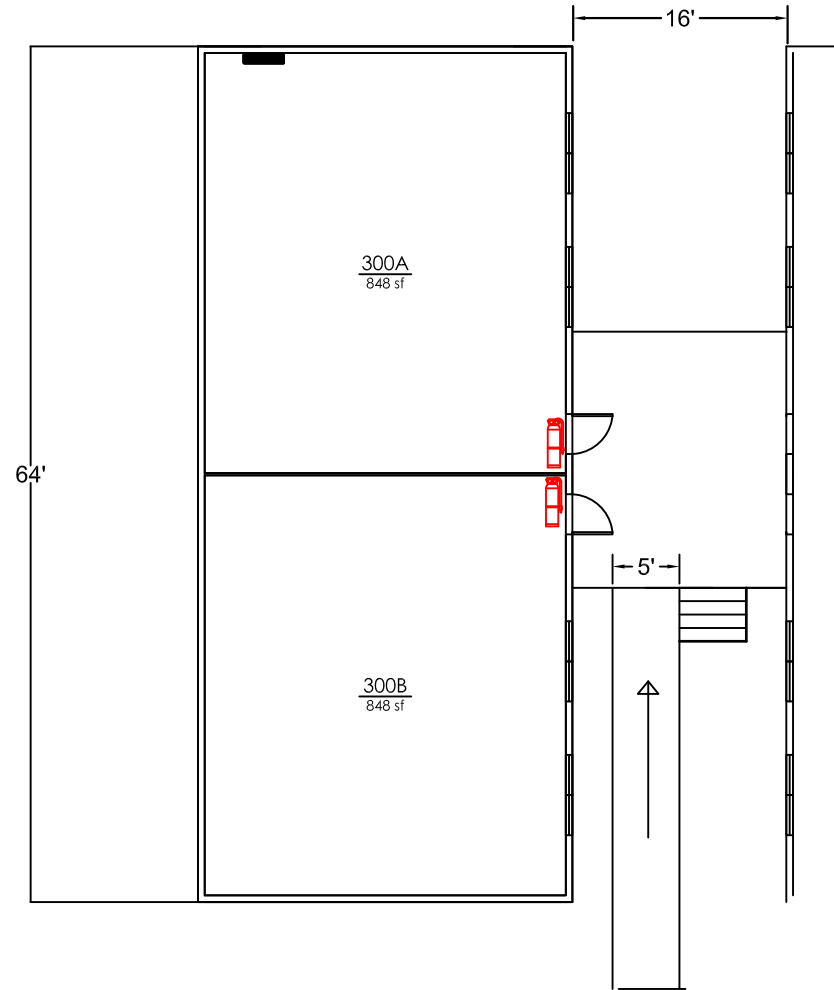
FLOOR
1



MODULAR BUILDING COMPLEX BUILDING C

 FICM Code 210 Classroom
 FICM Code 110 Classroom

 = FIRE EXTINGUISHER  = AED  = FIRE DEP. CONNECTION  = LOCK BOX  = FIRE ALARM CONTROL PANEL  = SPRINKLER HEADER **R** = SPRINKLER RISER  = Bottle Filler

DATE REVISED
10/15/2020

ADDRESS
1255 Athletics
LN



Square Feet
1696

BLDG NO
1333

(MBC) MODULAR BUILDING C

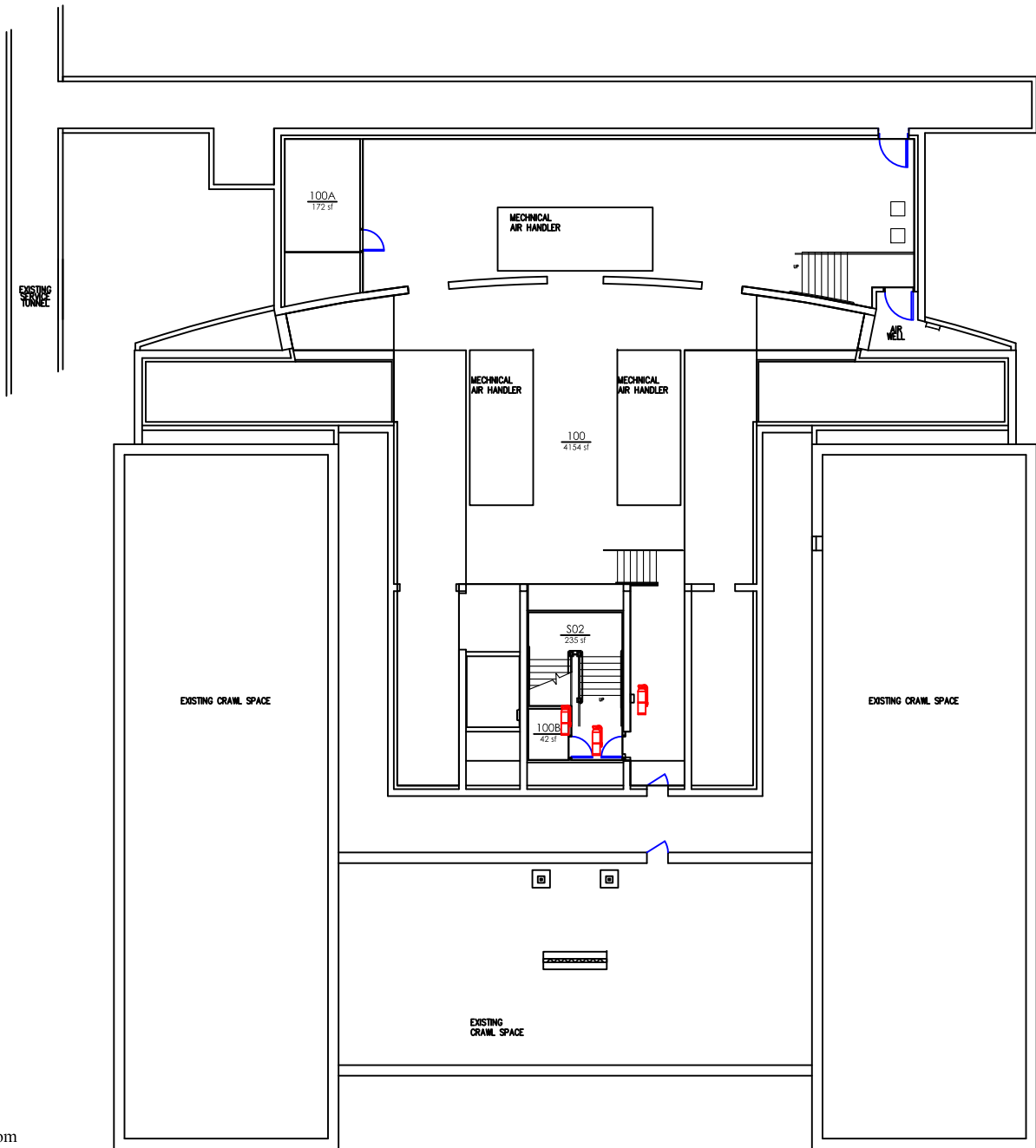
FLOOR
1



-  FICM Code 210 Classroom
-  FICM Code 110 Classroom

-  = FIRE EXTINGUISHER
-  = AED
-  = FIRE DEP. CONNECTION
-  = LOCK BOX
-  = FIRE ALARM CONTROL PANEL
-  = SPRINKLER HEADER
-  = SPRINKLER RISER
-  = Bottle Filler

DATE REVISED
09/15/2020

ADDRESS
532 Study LN

Square Feet
4691

BLDG NO
1118

(MON) MONROE HALL
BASEMENT

FLOOR
0

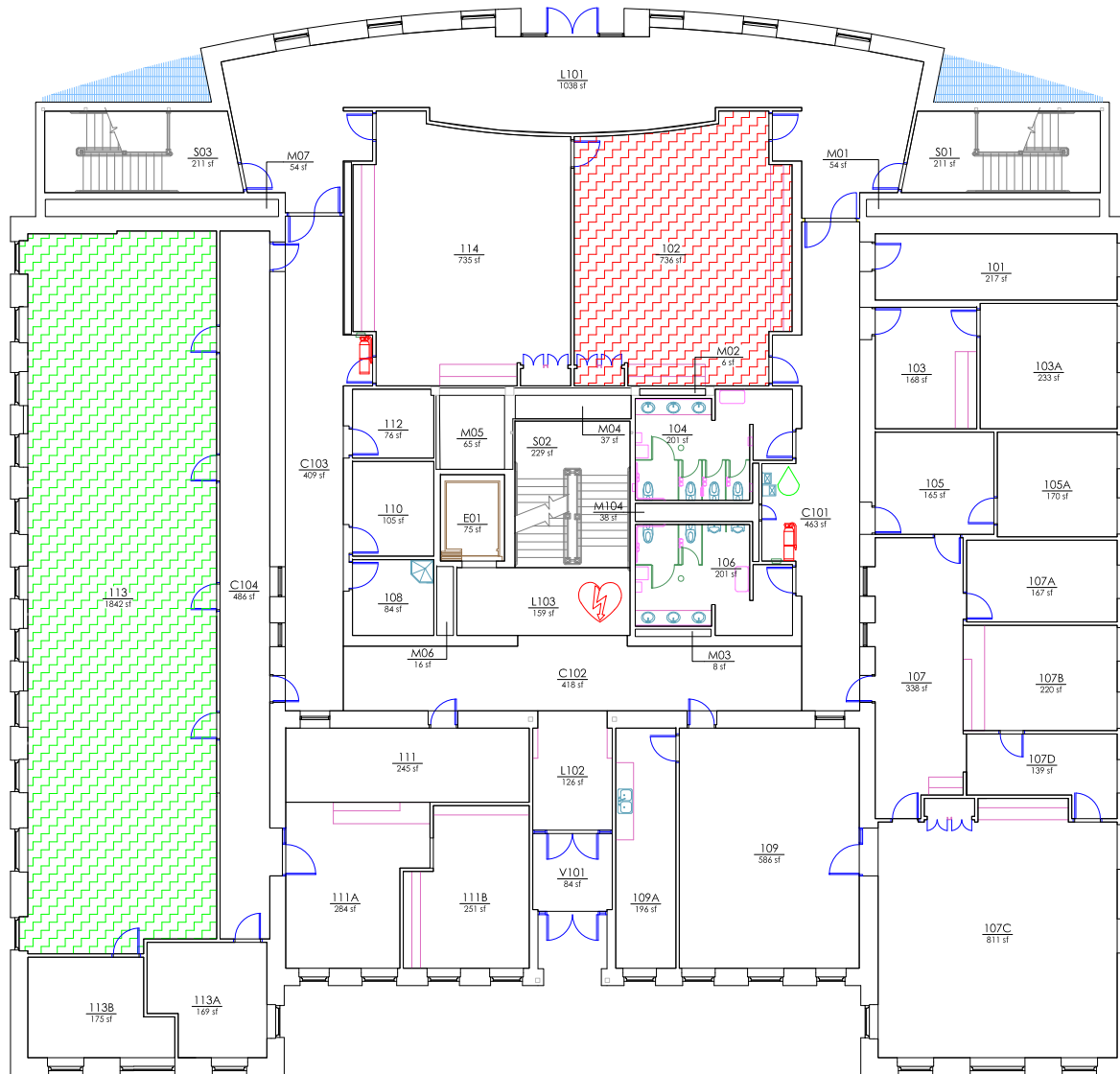

- FICM Code 210 Classroom
- FICM Code 110 Classroom

- = FIRE EXTINGUISHER
- = AED
- = FIRE DEP. CONNECTION
- = LOCK BOX
- = FIRE ALARM CONTROL PANEL
- = SPRINKLER HEADER
- = SPRINKLER RISER

DATE CREATED
02/01/2022

ADDRESS
532 Study LN



Square Feet
14768

AiM ID
1118

(MON) MONROE HALL
FIRST FLOOR

FLOOR
1



 FICM Code 210 Classroom
 FICM Code 110 Classroom

 = FIRE EXTINGUISHER  = AED  = FIRE DEP. CONNECTION  = LOCK BOX  = FIRE ALARM CONTROL PANEL  = SPRINKLER HEADER **R** = SPRINKLER RISER

DATE CREATED
02/01/2022

ADDRESS
532 Study LN

Square Feet
14867

AiM ID
1118

(MON) MONROE HALL
SECOND FLOOR

FLOOR
2

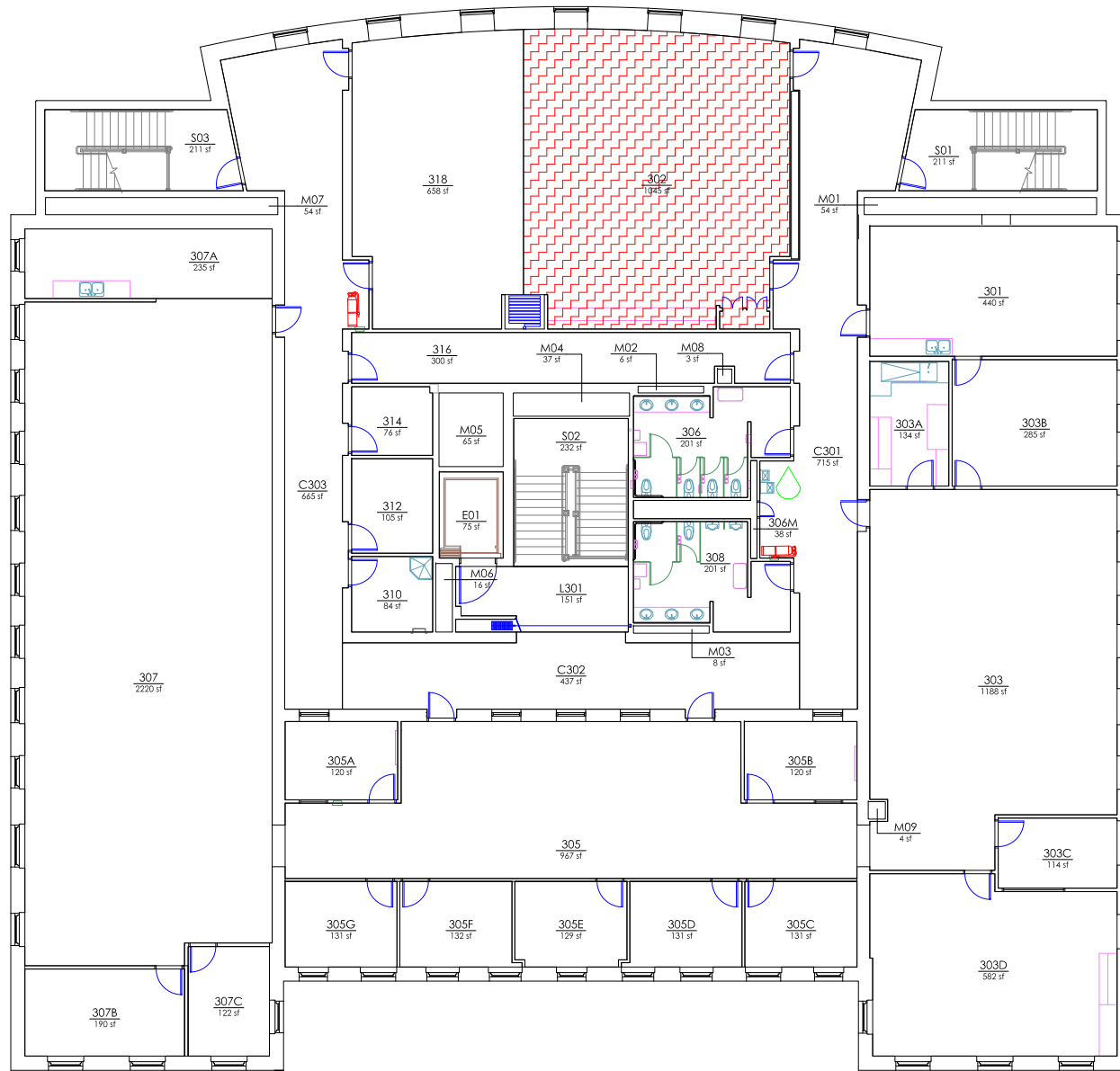

FICM Code 210 Classroom
 FICM Code 110 Classroom

= FIRE EXTINGUISHER = AED = FIRE DEP. CONNECTION = LOCK BOX = FIRE ALARM CONTROL PANEL = SPRINKLER HEADER = SPRINKLER RISER = Bottle Filler

DATE REVISED
02/01/2022

ADDRESS
532 Study LN

Square Feet
14867

BLDG NO
1118

(MON) MONROE HALL
THIRD FLOOR

FLOOR
3

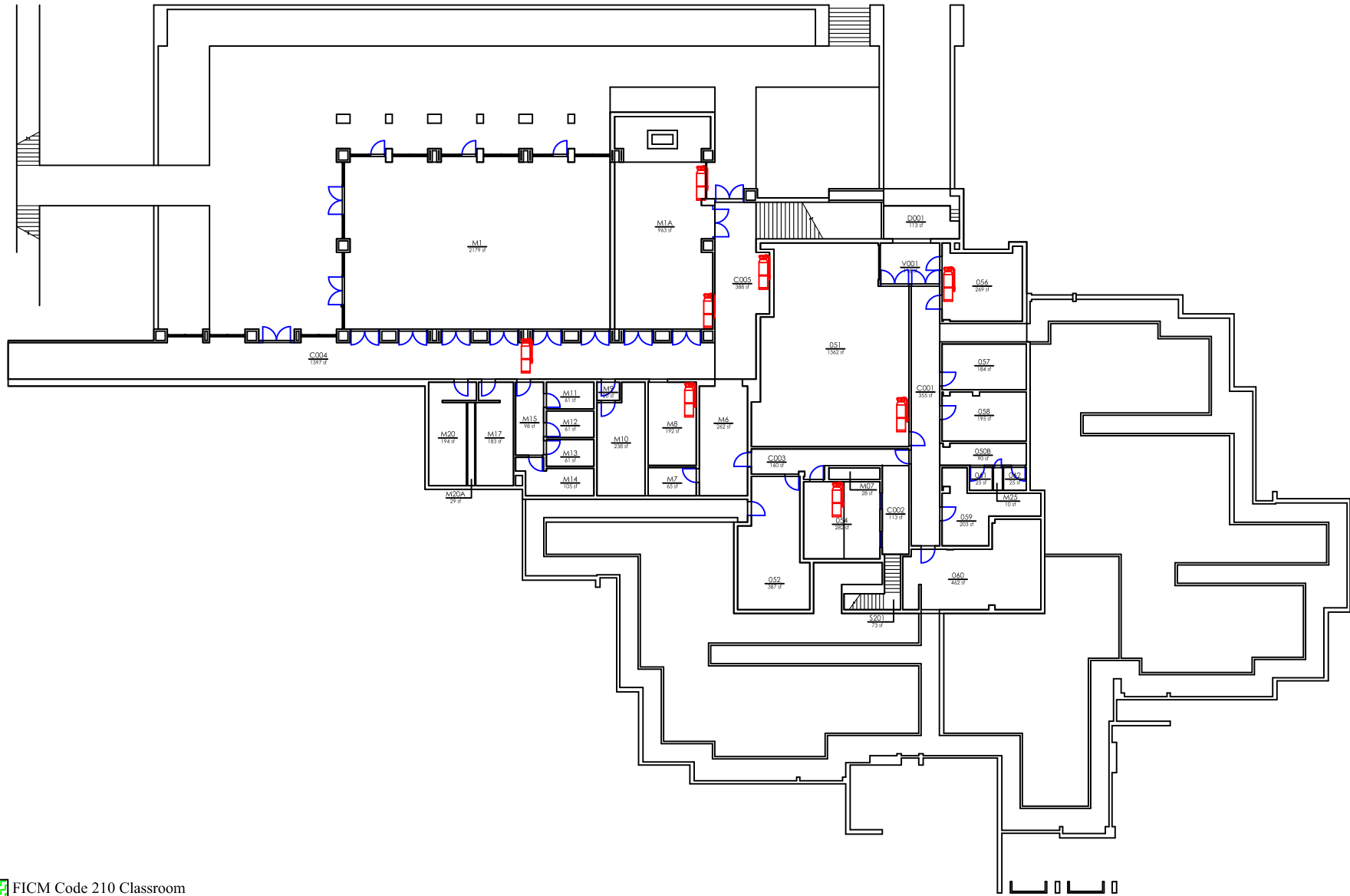



FICM Code 210 Classroom
 FICM Code 110 Classroom

= FIRE EXTINGUISHER = AED = FIRE DEP. CONNECTION = LOCK BOX = FIRE ALARM CONTROL PANEL = SPRINKLER HEADER **R** = SPRINKLER RISER = Bottle Filler

DATE REVISED 10/15/2020	ADDRESS 218 N. 10th ST	Square Feet 12693	BLDG NO 1463	(MOR) MORRISON HALL BASEMENT	FLOOR 0
----------------------------	---------------------------	----------------------	-----------------	---------------------------------	------------





 FICM Code 210 Classroom
 FICM Code 110 Classroom

 = FIRE EXTINGUISHER  = AED  = FIRE DEP. CONNECTION  = LOCK BOX  = FIRE ALARM CONTROL PANEL  = SPRINKLER HEADER **R** = SPRINKLER RISER  = Bottle Filler

DATE REVISED 10/16/2018	ADDRESS 218 N. 10th Street	Square Feet 4491	BLDG NO 1463	(MOR) MORRISON HALL FIRST FLOOR	FLOOR 1
----------------------------	-------------------------------	---------------------	-----------------	------------------------------------	------------



 FICM Code 210 Classroom
 FICM Code 110 Classroom

 = FIRE EXTINGUISHER  = AED  = FIRE DEP. CONNECTION  = LOCK BOX  = FIRE ALARM CONTROL PANEL  = SPRINKLER HEADER **R** = SPRINKLER RISER  = Bottle Filler

DATE REVISED
10/16/2020

ADDRESS
218 N. 10th Street



Square Feet
16409

BLDG NO
1463

(MOR) MORRISON HALL
LOBBY AND SECOND FLOOR

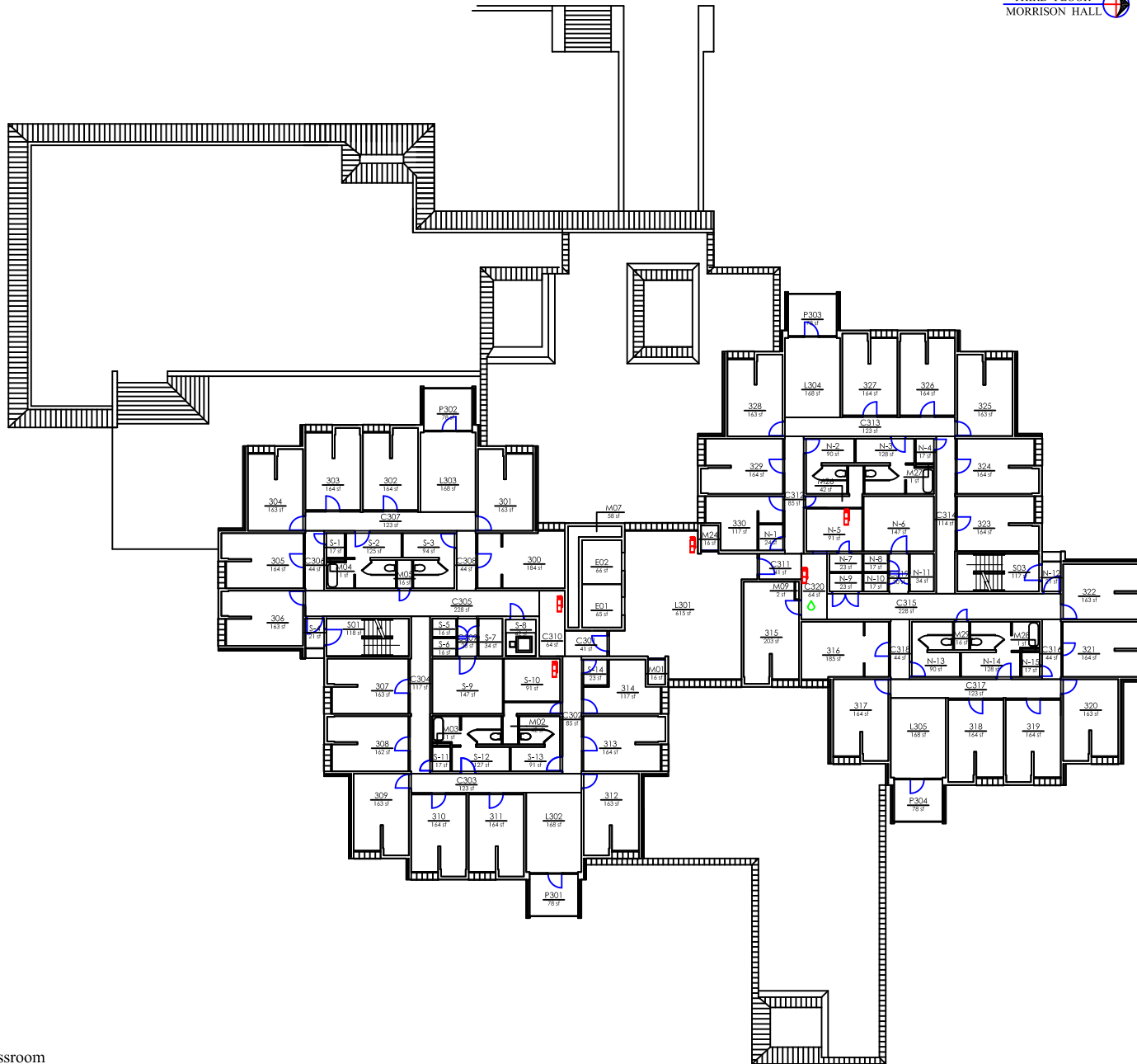
FLOOR
2





 FICM Code 210 Classroom
 FICM Code 110 Classroom

 = FIRE EXTINGUISHER  = AED  = FIRE DEP. CONNECTION  = LOCK BOX  = FIRE ALARM CONTROL PANEL  = SPRINKLER HEADER  = SPRINKLER RISER  = Bottle Filler

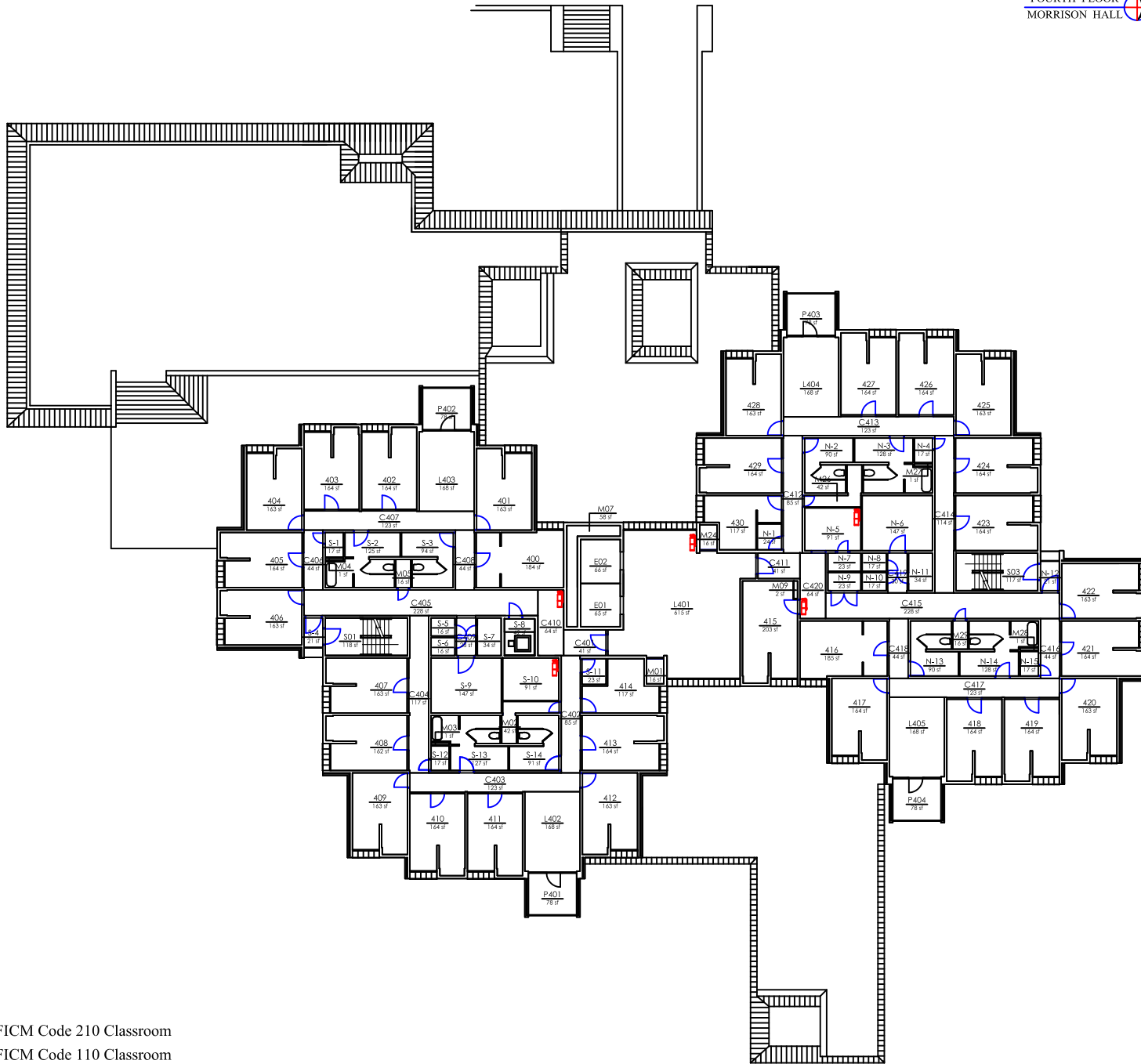
DATE REVISED 10/20/2020	ADDRESS 218 N. 10th Street	Square Feet 12286	BLDG NO 1463	(MOR) MORISON HALL THIRD FLOOR	FLOOR 3
----------------------------	-------------------------------	----------------------	-----------------	-----------------------------------	------------





 FICM Code 210 Classroom
 FICM Code 110 Classroom

 = FIRE EXTINGUISHER  = AED  = FIRE DEP. CONNECTION  = LOCK BOX  = FIRE ALARM CONTROL PANEL  = SPRINKLER HEADER **R** = SPRINKLER RISER  = Bottle Filler

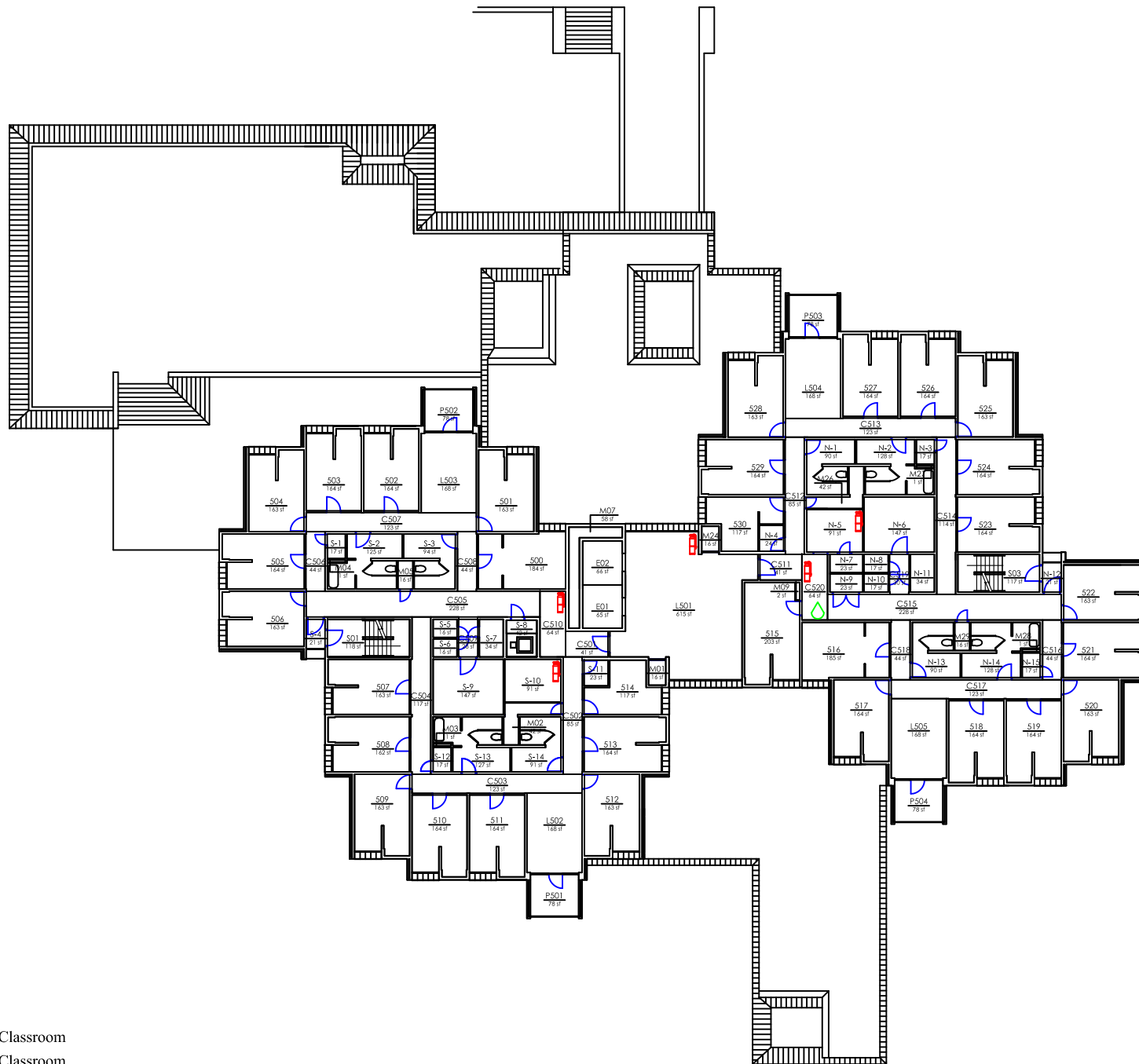
DATE REVISED	ADDRESS	Square Feet	BLDG NO	(MOR) MORRISON HALL FOURTH FLOOR	FLOOR
10/20/2020	218 N. 10th Street	12286	1463		4





 FICM Code 210 Classroom
 FICM Code 110 Classroom

 = FIRE EXTINGUISHER  = AED  = FIRE DEP. CONNECTION  = LOCK BOX  = FIRE ALARM CONTROL PANEL  = SPRINKLER HEADER **R** = SPRINKLER RISER  = Bottle Filler

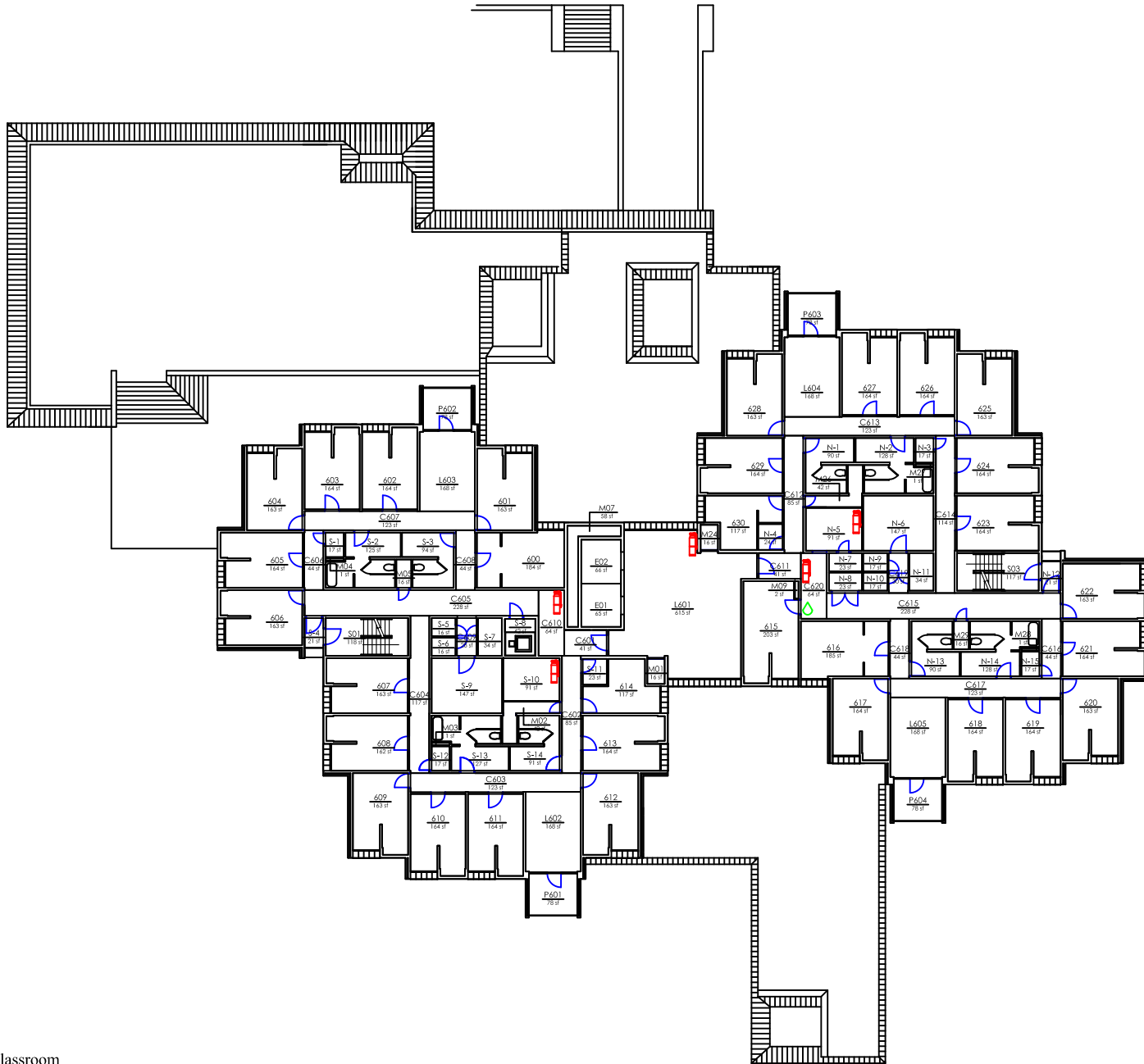
DATE REVISED	ADDRESS	Square Feet	BLDG NO	(MOR) MORRISON HALL FIFTH FLOOR		FLOOR
10/20/2020	218 N. 10th Street	12286	1463			5





 FICM Code 210 Classroom
 FICM Code 110 Classroom

 = FIRE EXTINGUISHER  = AED  = FIRE DEP. CONNECTION  = LOCK BOX  = FIRE ALARM CONTROL PANEL  = SPRINKLER HEADER  = SPRINKLER RISER  = Bottle Filler

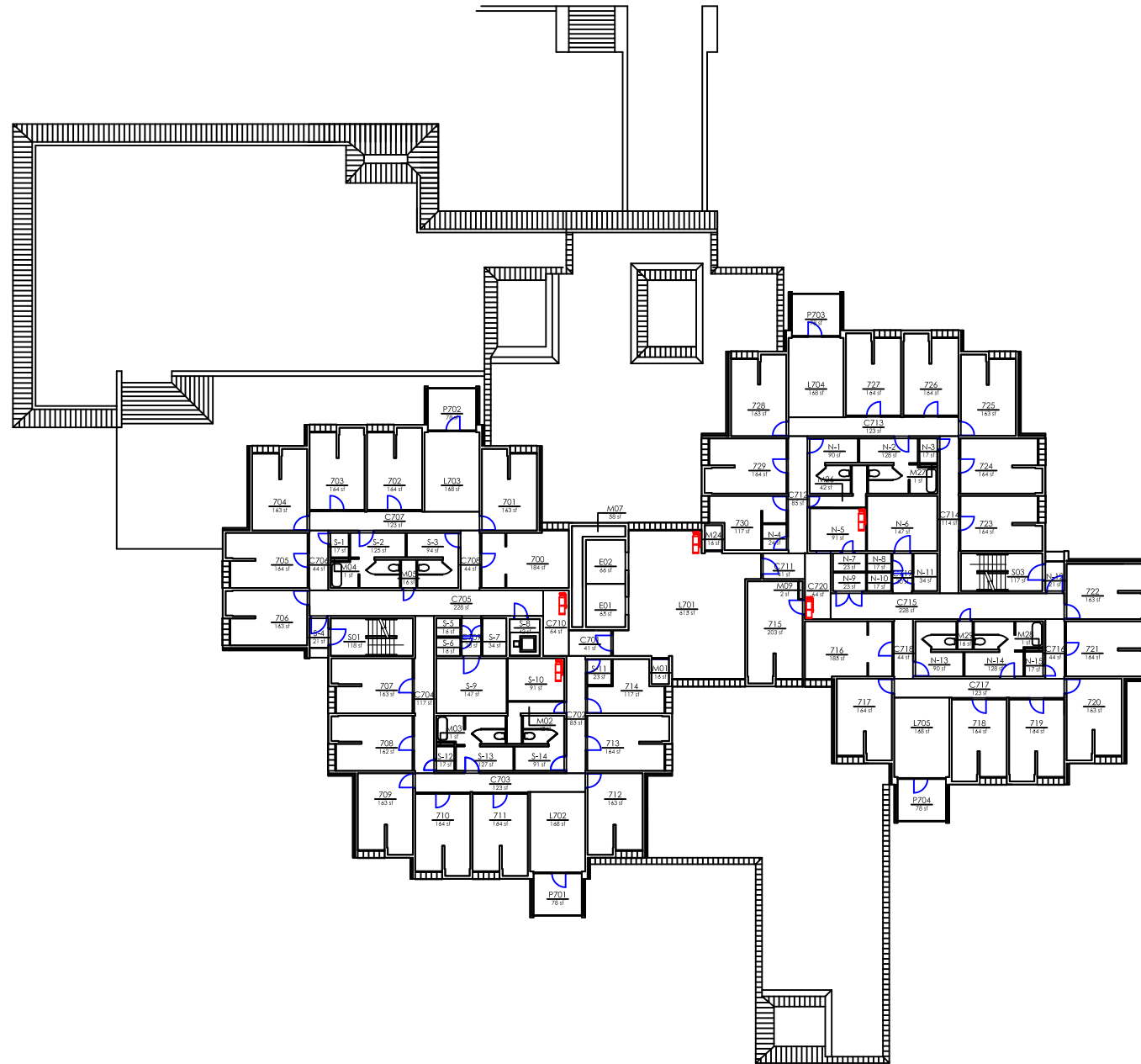
DATE REVISED	ADDRESS	Square Feet	BLDG NO	(MOR) MORRISON HALL SIXTH FLOOR	FLOOR
10/20/2020	218 N. 10th Street	12286	1643		6





 FICM Code 210 Classroom
 FICM Code 110 Classroom

 = FIRE EXTINGUISHER  = AED  = FIRE DEP. CONNECTION  = LOCK BOX  = FIRE ALARM CONTROL PANEL  = SPRINKLER HEADER **R** = SPRINKLER RISER  = Bottle Filler

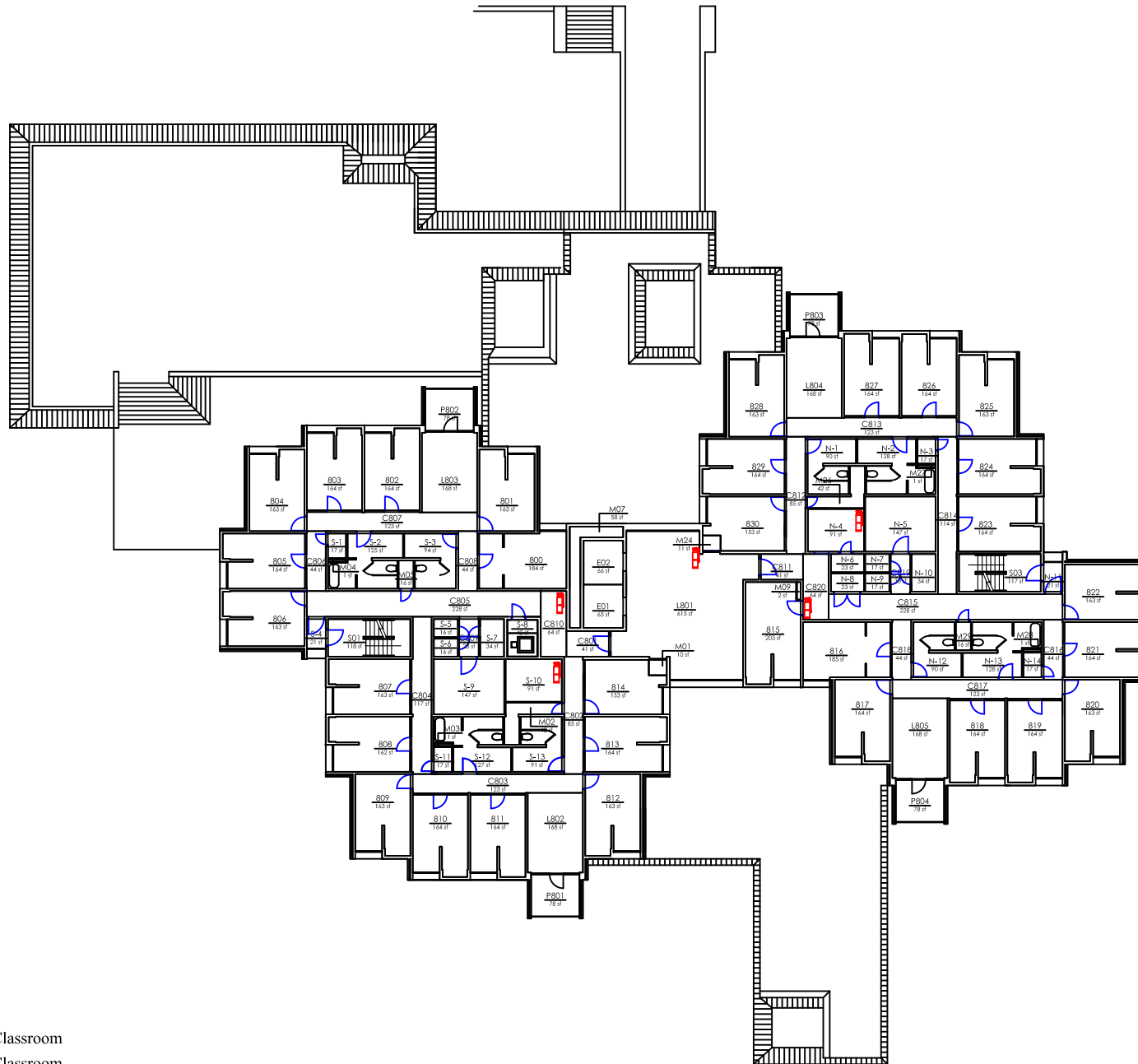
DATE REVISED	ADDRESS	Square Feet	BLDG NO	(MOR) MORRISON HALL		FLOOR
10/20/2020	218 N. 10th Street	12286	1463	SEVENTH FLOOR		7



 FICM Code 210 Classroom
 FICM Code 110 Classroom



 = FIRE EXTINGUISHER  = AED  = FIRE DEP. CONNECTION  = LOCK BOX  = FIRE ALARM CONTROL PANEL  = SPRINKLER HEADER  = SPRINKLER RISER  = Bottle Filler

DATE REVISED 10/20/2020	ADDRESS 218 N. 10th Street	Square Feet 12286	BLDG NO 1463	(MOR) MORRISON HALL EIGHTH FLOOR	FLOOR 8
----------------------------	-------------------------------	----------------------	-----------------	-------------------------------------	------------

DRAWINGS ARE NOT TO SCALE

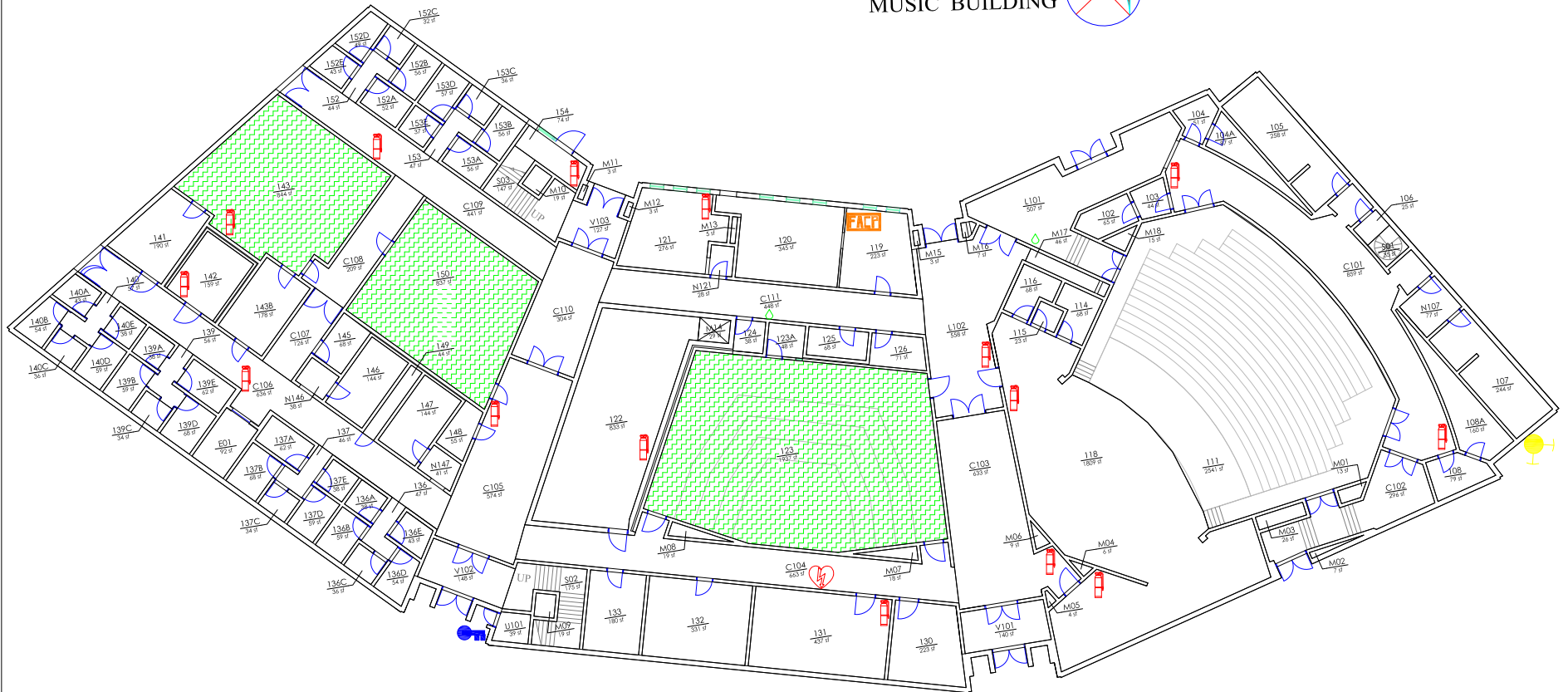
FIRST FLOOR
MUSIC BUILDING

 FICM Code 210 Classroom
 FICM Code 110 Classroom



 = FIRE EXTINGUISHER  = AED  = FIRE DEP. CONNECTION  = LOCK BOX  = FIRE ALARM CONTROL PANEL  = SPRINKLER HEADER **R** = SPRINKLER RISER  = Bottle Filler

DATE REVISED 02/01/2022	ADDRESS 20 7th Street	Square Feet 25245	BLDG NO 1139	(MUS) MUSIC BUILDING FIRST FLOOR	FLOOR 1
----------------------------	--------------------------	----------------------	-----------------	-------------------------------------	------------

DRAWINGS ARE NOT TO SCALE

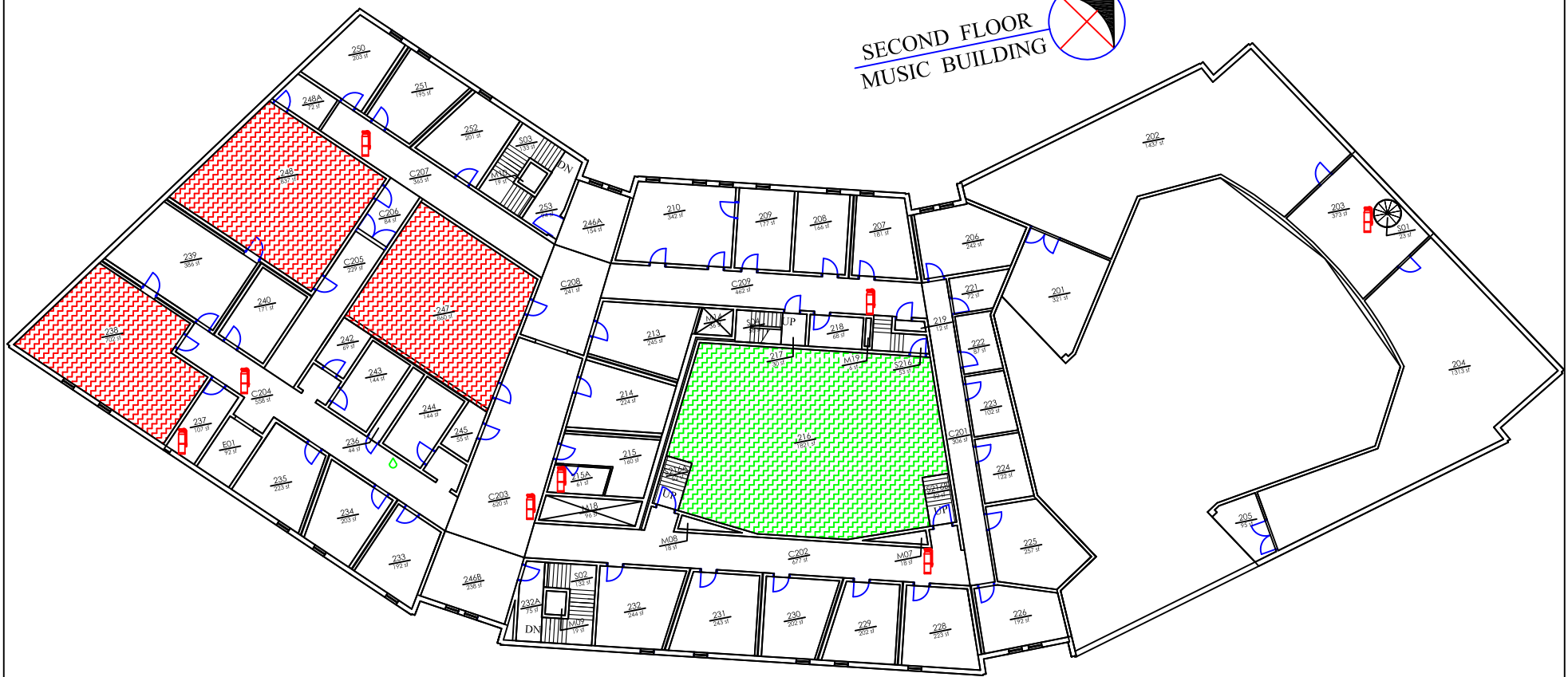
SECOND FLOOR MUSIC BUILDING



 FICM Code 210 Classroom
 FICM Code 110 Classroom

 = FIRE EXTINGUISHER  = AED  = FIRE DEP. CONNECTION  = LOCK BOX  = FIRE ALARM CONTROL PANEL  = SPRINKLER HEADER  = SPRINKLER RISER  = Bottle Filler

DATE REVISED 07/31/2020	ADDRESS 20 7th Street	Square Feet 21234	BLDG NO 1139	(MUS) MUSIC BUILDING SECOND FLOOR	FLOOR 2
----------------------------	--------------------------	----------------------	-----------------	--------------------------------------	------------

DRAWINGS ARE NOT TO SCALE

THIRD FLOOR MUSIC BUILDING

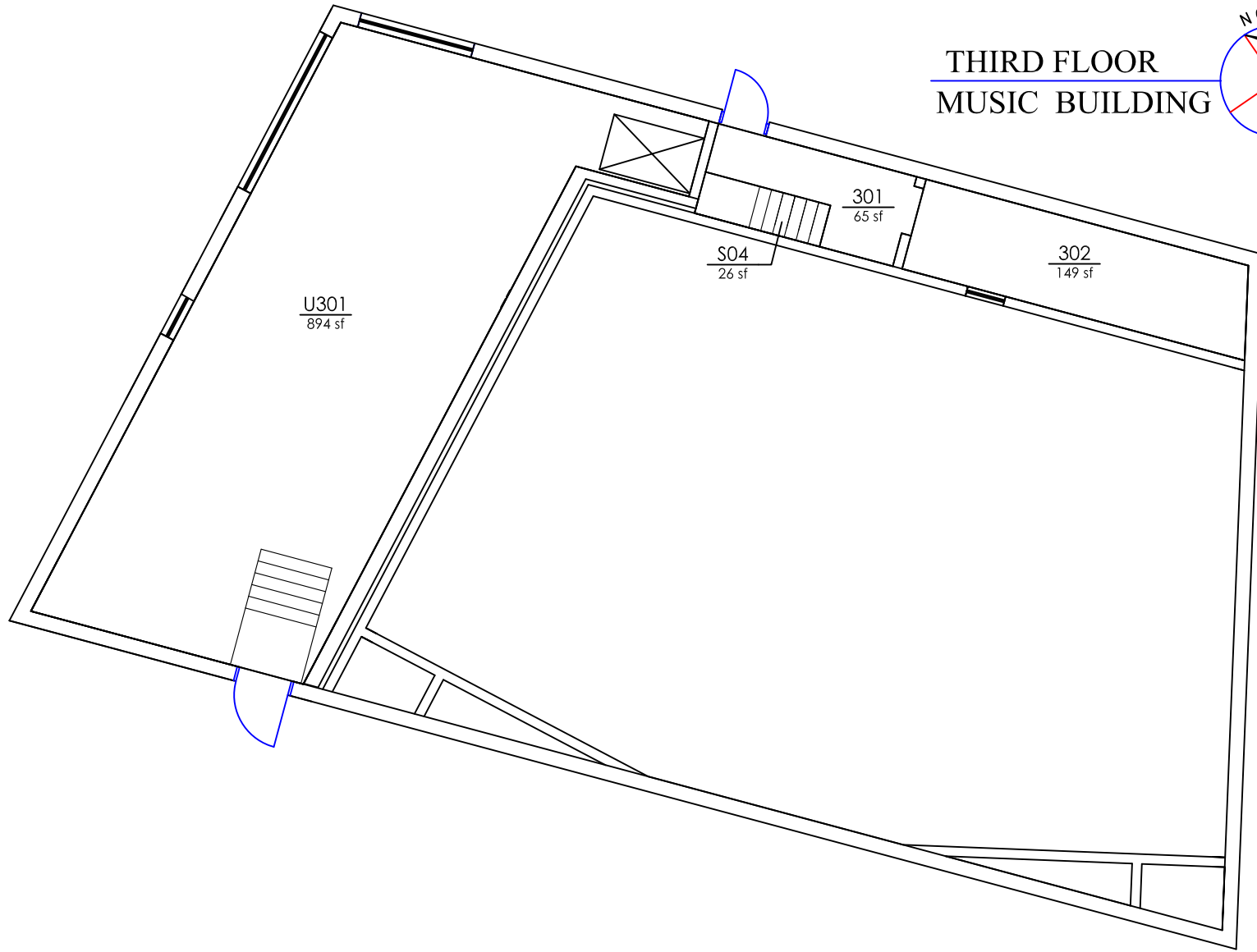
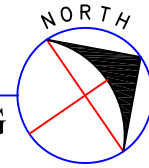

- FICM Code 210 Classroom
- FICM Code 110 Classroom

- = FIRE EXTINGUISHER
- = AED
- = FIRE DEP. CONNECTION
- = LOCK BOX
- = FIRE ALARM CONTROL PANEL
- = SPRINKLER HEADER
- = SPRINKLER RISER
- = Bottle Filler

DATE REVISED
07/31/2020

ADDRESS
20 7th Street

Square Feet
1139

BLDG NO
1139

(MUS) MUSIC BUILDING
THIRD FLOOR



FLOOR
3

DRAWINGS ARE NOT TO SCALE

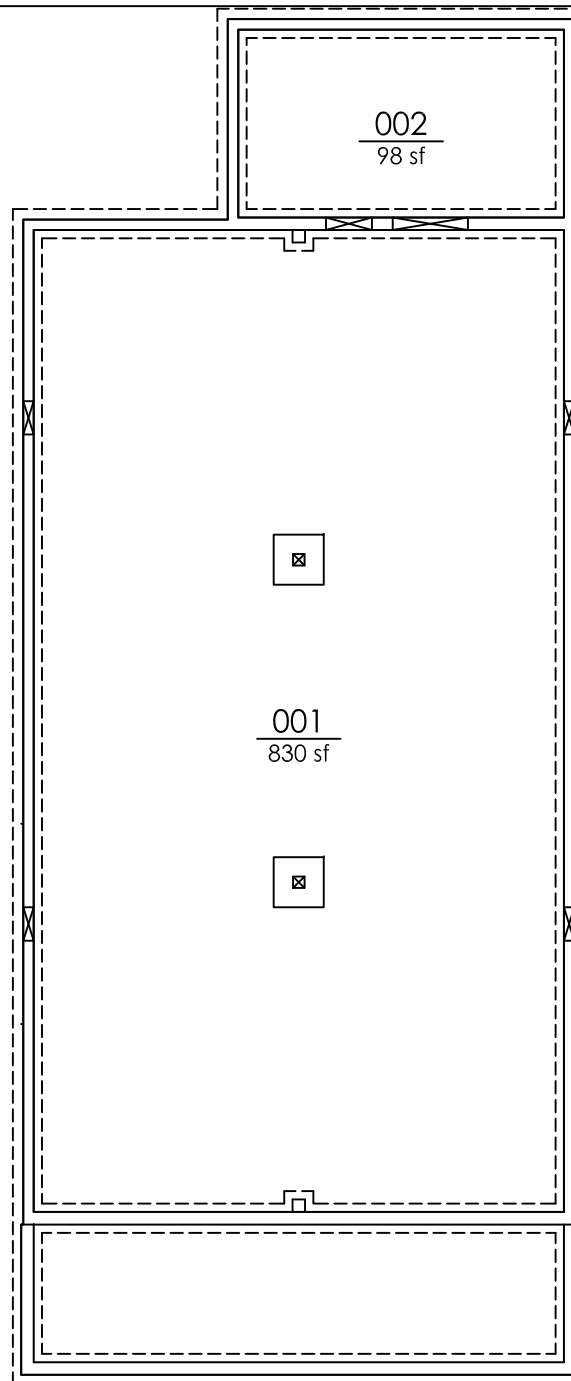

CRAWL SPACE ONE ROOM SCHOOLHOUSE



-  FICM Code 210 Classroom
-  FICM Code 110 Classroom

-  = FIRE EXTINGUISHER
-  = AED
-  = FIRE DEP. CONNECTION
-  = LOCK BOX
-  = FIRE ALARM CONTROL PANEL
-  = SPRINKLER HEADER
-  = SPRINKLER RISER
-  = Bottle Filler

DATE REVISED
07/31/2020

ADDRESS
339 Media LN

Square Feet
1010

BLDG NO
1127

(ORS) ONE ROOM SCHOOL HOUSE
CRAWL SPACE



FLOOR
0

DRAWINGS ARE NOT TO SCALE

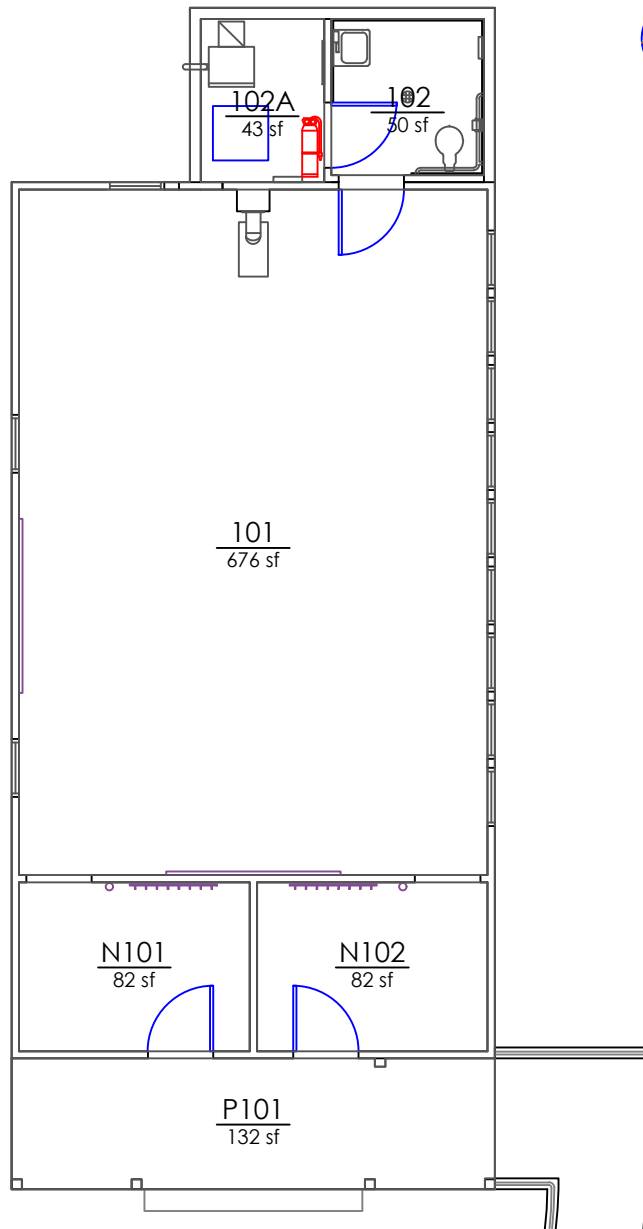

MAIN FLOOR
ONE ROOM SCHOOLHOUSE





 FICM Code 210 Classroom
 FICM Code 110 Classroom

 = FIRE EXTINGUISHER  = AED  = FIRE DEP. CONNECTION  = LOCK BOX  = FIRE ALARM CONTROL PANEL  = SPRINKLER HEADER **R** = SPRINKLER RISER  = Bottle Filler

DATE REVISED 02/01/2022	ADDRESS 339 Media LN	Square Feet 1136	BLDG NO 1127	(ORS) ONE ROOM SCHOOL HOUSE FIRST FLOOR	FLOOR 1
----------------------------	-------------------------	---------------------	-----------------	--	------------

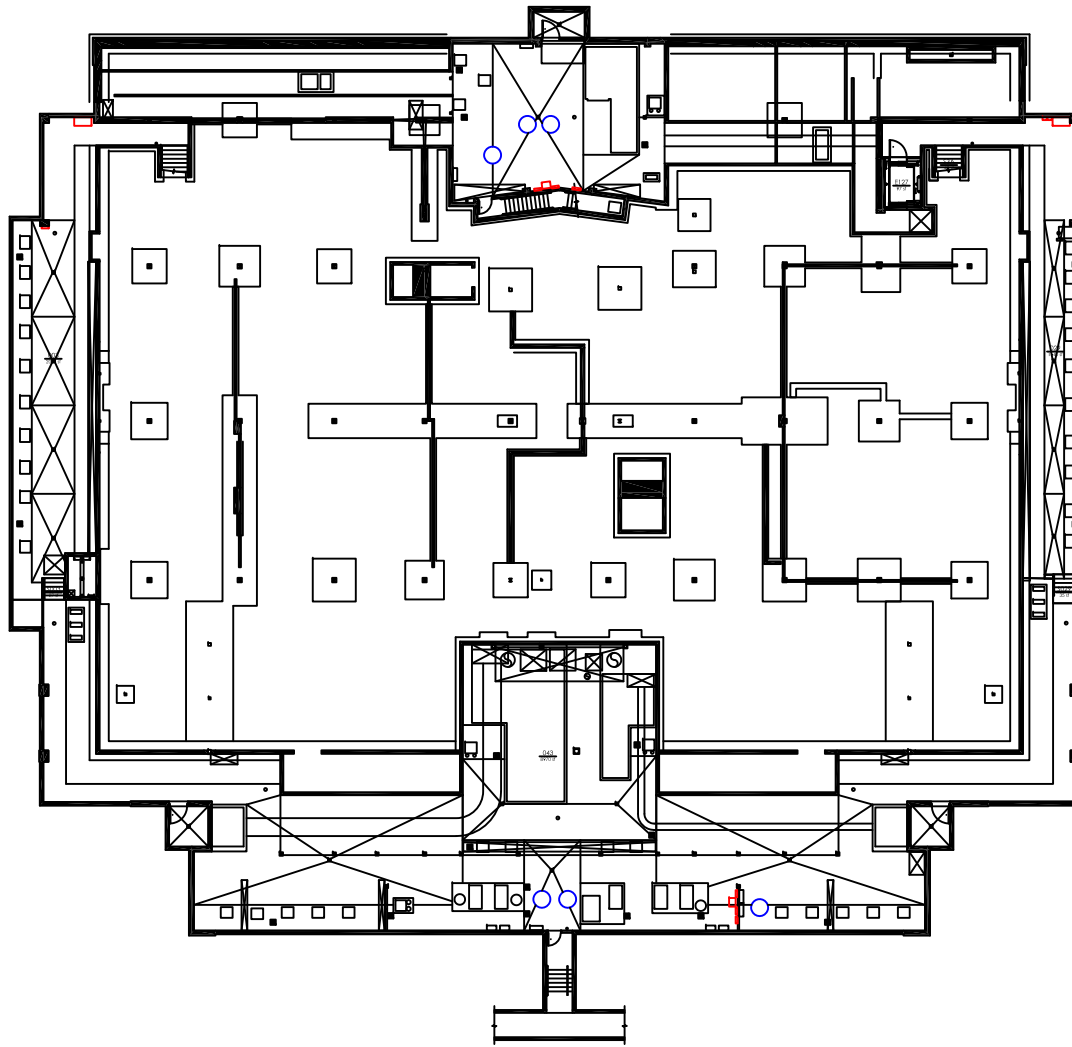
DRAWINGS ARE NOT TO SCALE





 FICM Code 210 Classroom
 FICM Code 110 Classroom

 = FIRE EXTINGUISHER  = AED  = FIRE DEP. CONNECTION  = LOCK BOX  = FIRE ALARM CONTROL PANEL  = SPRINKLER HEADER **R** = SPRINKLER RISER  = Bottle Filler

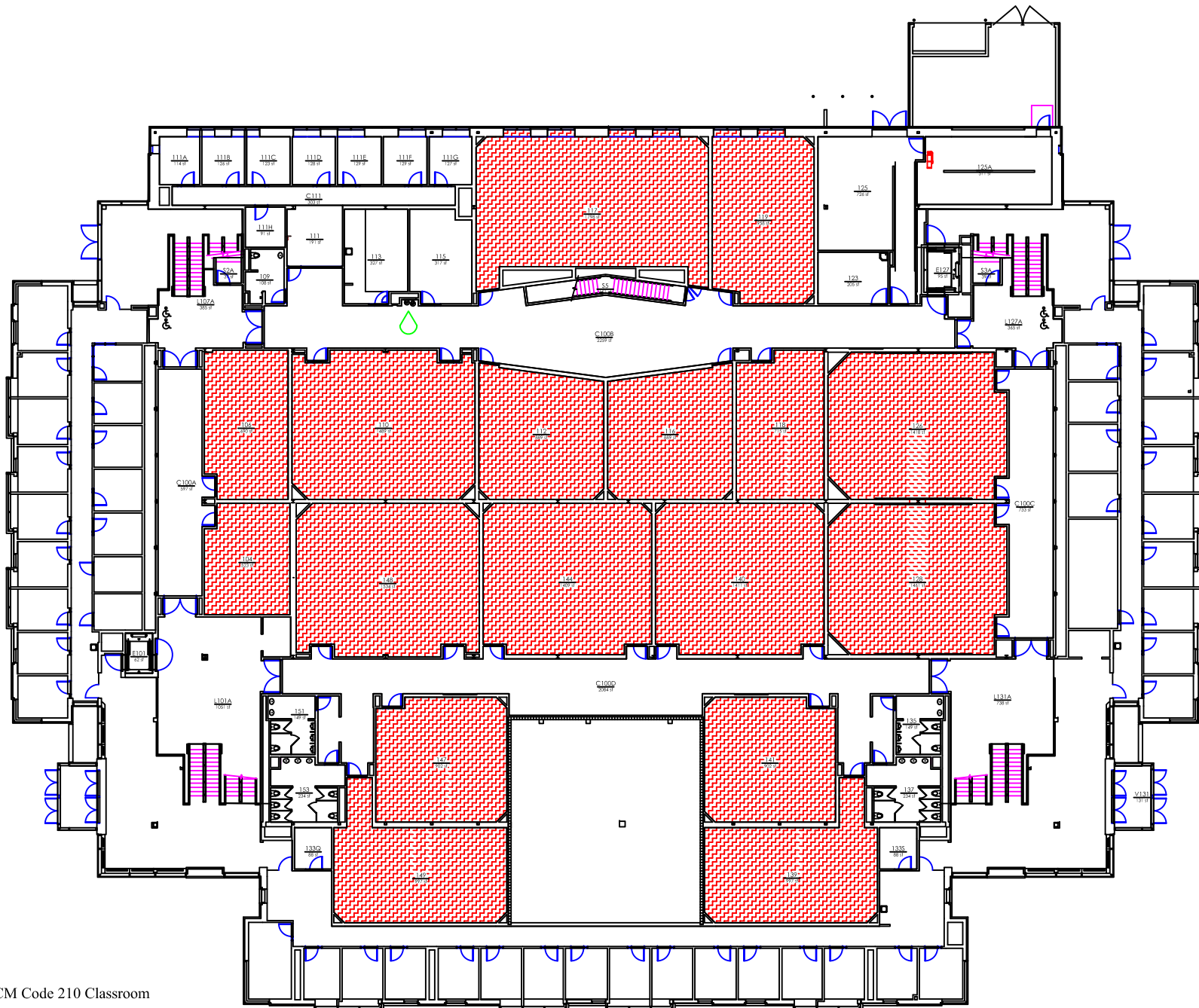
DATE REVISED	ADDRESS	Square Feet	BLDG NO	(PAT) PATTERSON HALL BASEMENT	FLOOR
09/18/2020	530 Quad LN	1713			0



-  FICM Code 210 Classroom
-  FICM Code 110 Classroom

-  = FIRE EXTINGUISHER
-  = AED
-  = FIRE DEP. CONNECTION
-  = LOCK BOX
-  = FIRE ALARM CONTROL PANEL
-  = SPRINKLER HEADER
- R** = SPRINKLER RISER
-  = Bottle Filler

DATE REVISED
09/18/2020

ADDRESS
530 Quad LN

Square Feet
53674

BLDG NO
1713

(PAT) PATTERSON HALL
FIRST FLOOR CLASSROOMS

FLOOR
1

DRAWINGS ARE NOT TO SCALE

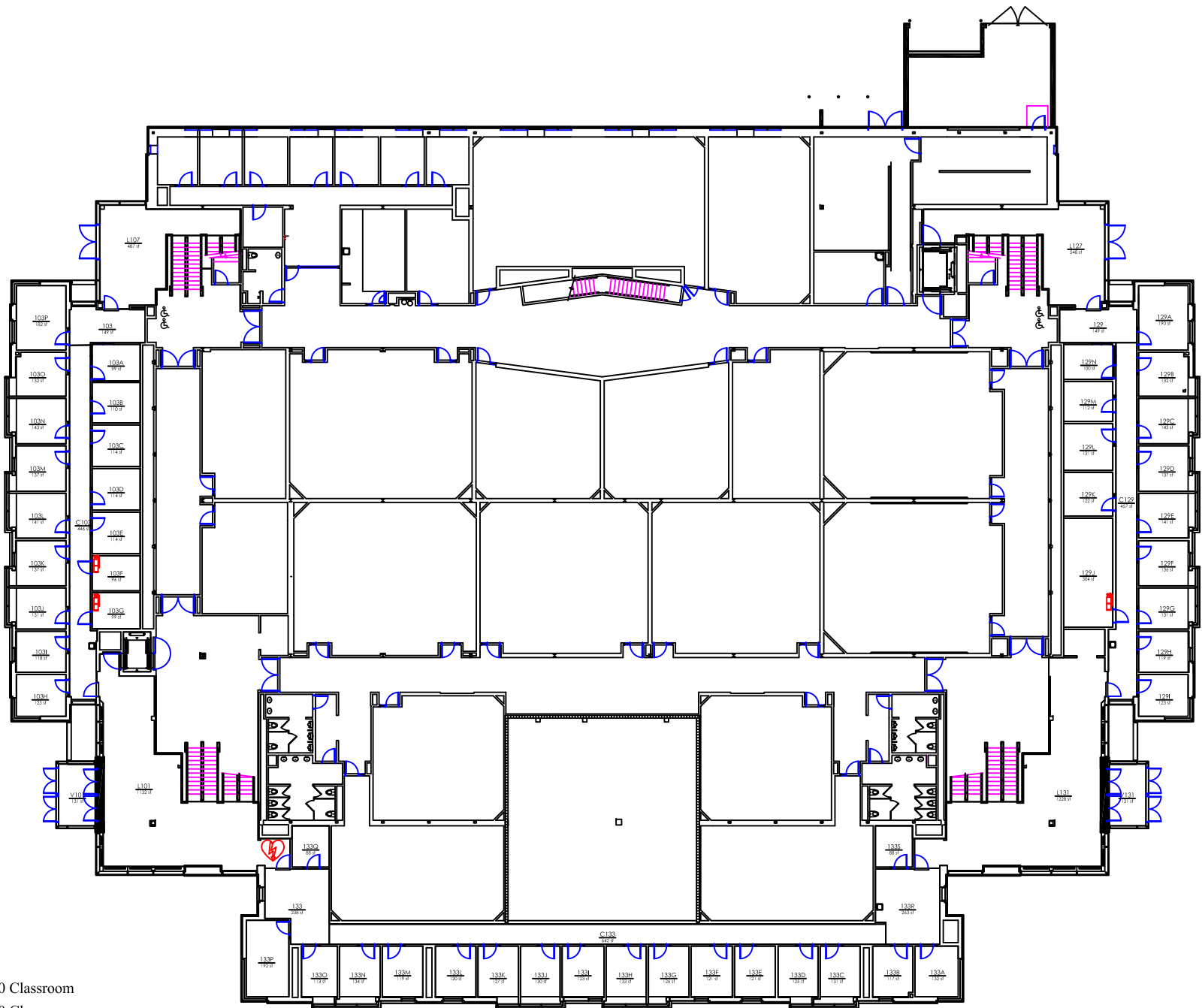



FICM Code 210 Classroom
 FICM Code 110 Classroom

= FIRE EXTINGUISHER = AED = FIRE DEP. CONNECTION = LOCK BOX = FIRE ALARM CONTROL PANEL = SPRINKLER HEADER = SPRINKLER RISER = Bottle Filler

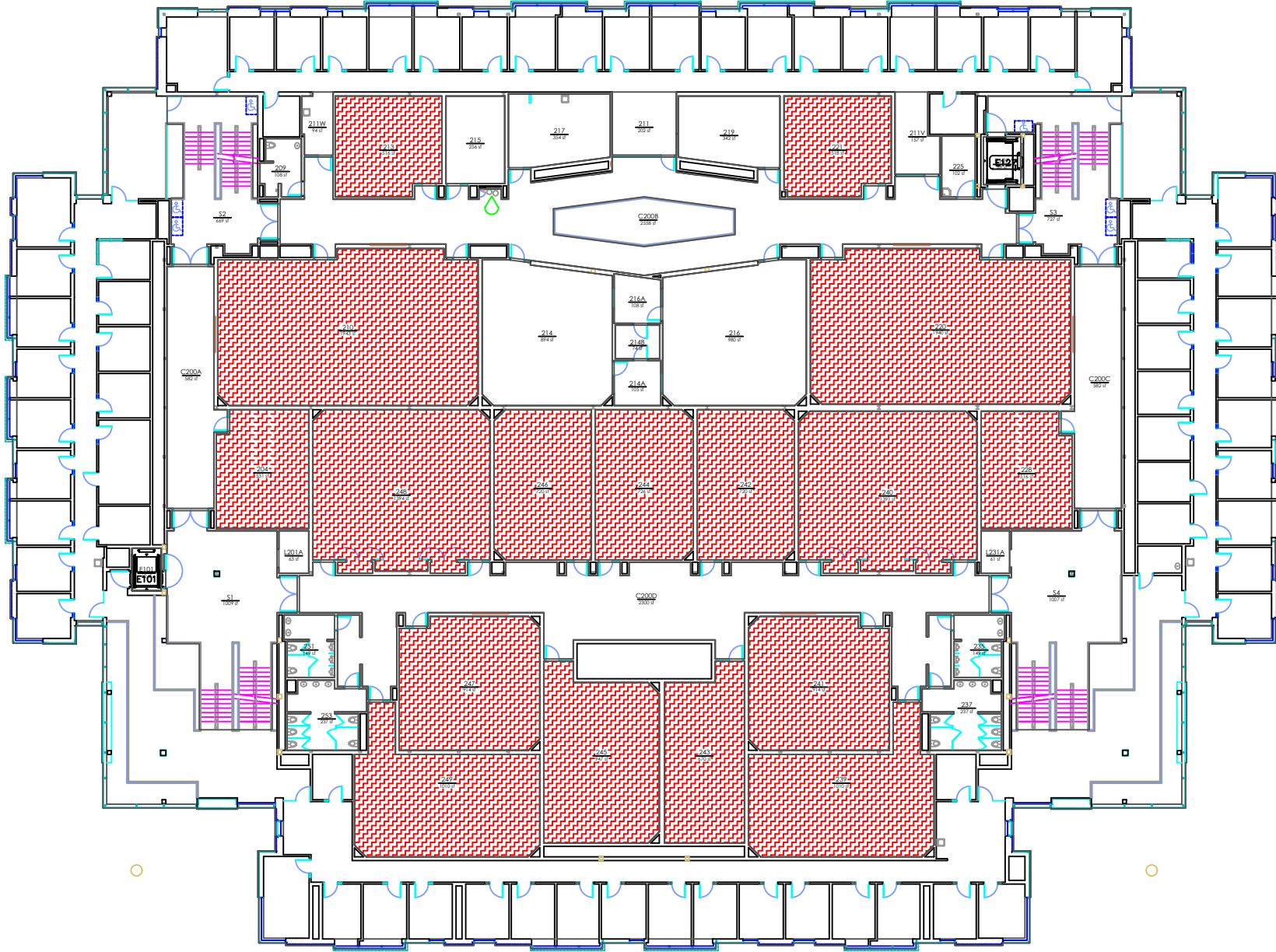
DATE REVISED 09/18/2020	ADDRESS 530 Quad LN	Square Feet 53674	BLDG NO 1713	(PAT) PATTERSON HALL FIRST FLOOR OFFICES	FLOOR 1.5
----------------------------	------------------------	----------------------	-----------------	---	--------------





 FICM Code 210 Classroom
 FICM Code 110 Classroom

 = FIRE EXTINGUISHER  = AED  = FIRE DEP. CONNECTION  = LOCK BOX  = FIRE ALARM CONTROL PANEL  = SPRINKLER HEADER **R** = SPRINKLER RISER  = Bottle Filler

DATE REVISED 02/01/2022	ADDRESS 530 Quad LN	Square Feet 52281	BLDG NO 1713	(PAT) PATTERSON HALL SECOND FLOOR CLASSROOMS	FLOOR 2
----------------------------	------------------------	----------------------	-----------------	---	------------

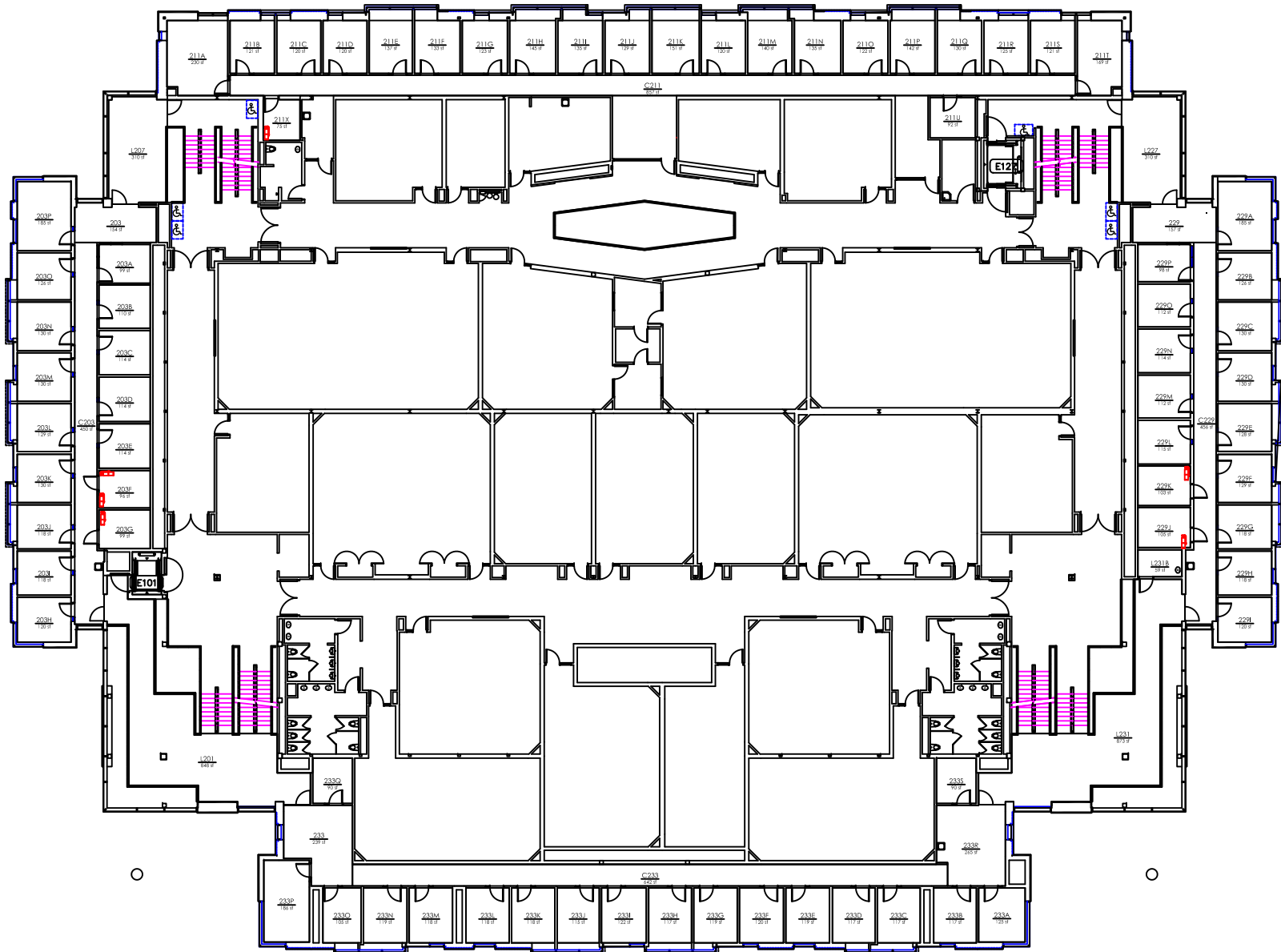
DRAWINGS ARE NOT TO SCALE





 FICM Code 210 Classroom
 FICM Code 110 Classroom

 = FIRE EXTINGUISHER  = AED  = FIRE DEP. CONNECTION  = LOCK BOX  = FIRE ALARM CONTROL PANEL  = SPRINKLER HEADER **R** = SPRINKLER RISER  = Bottle Filler

DATE REVISED 09/18/2020	ADDRESS 530 Quad LN	Square Feet 52281	BLDG NO 1713	(PAT) PATTERSON HALL SECOND FLOOR OFFICES	FLOOR 2.5
----------------------------	------------------------	----------------------	-----------------	--	--------------

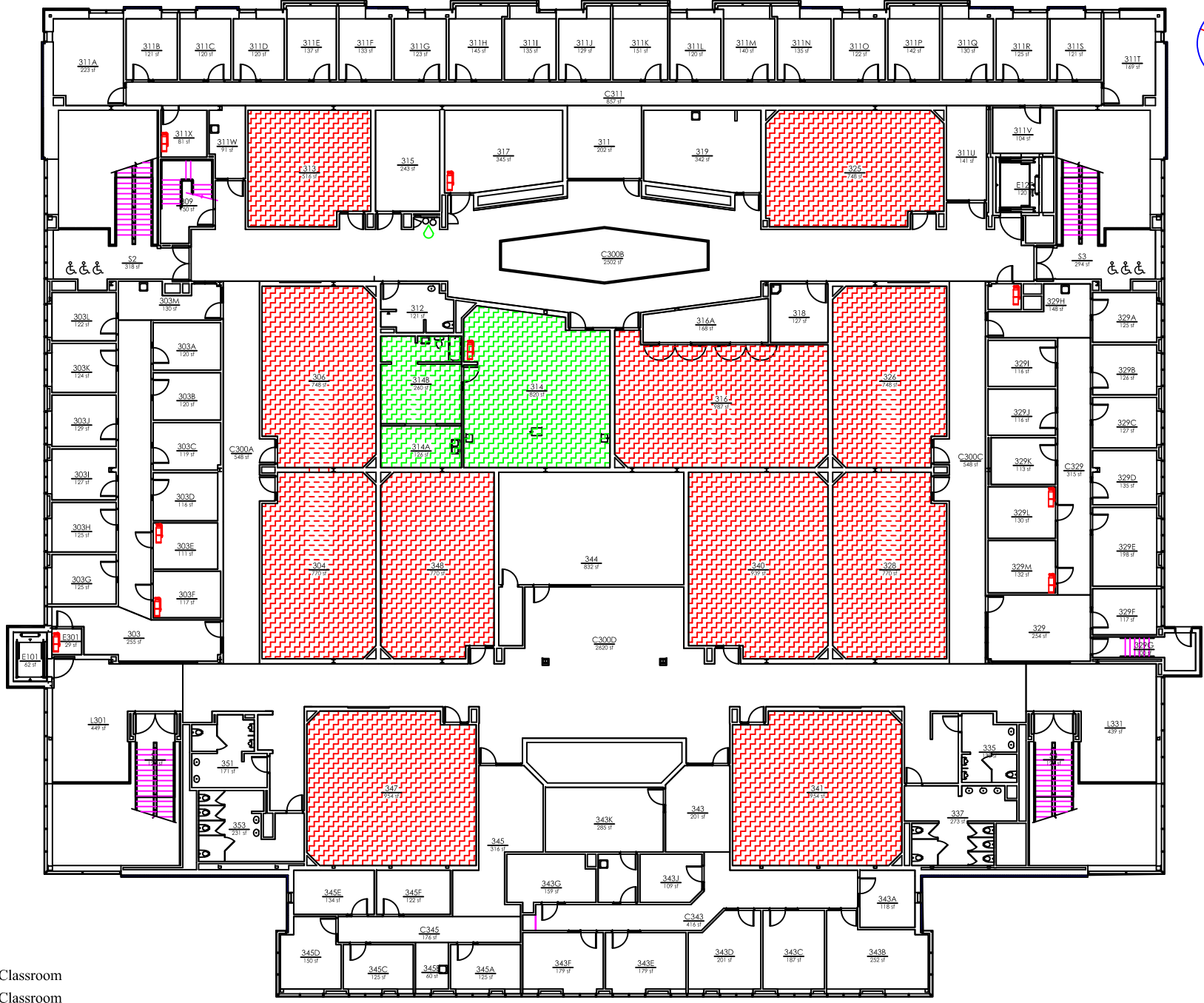
DRAWINGS ARE NOT TO SCALE



 FICM Code 210 Classroom
 FICM Code 110 Classroom

 = FIRE EXTINGUISHER  = AED  = FIRE DEP. CONNECTION  = LOCK BOX  = FIRE ALARM CONTROL PANEL  = SPRINKLER HEADER  = SPRINKLER RISER  = Bottle Filler

DATE REVISED
09/18/2020

ADDRESS
530 Quad LN

Square Feet
39581



BLDG NO
1713

(PAT) PATTERSON HALL
THIRD FLOOR

FLOOR
3

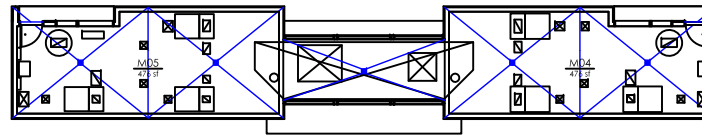
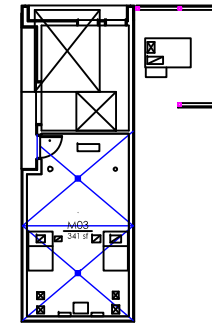
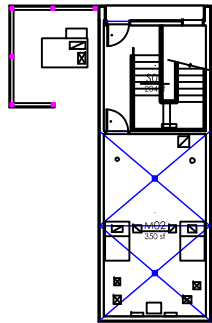
DRAWINGS ARE NOT TO SCALE



-  FICM Code 210 Classroom
-  FICM Code 110 Classroom

-  = FIRE EXTINGUISHER
-  = AED
-  = FIRE DEP. CONNECTION
-  = LOCK BOX
-  = FIRE ALARM CONTROL PANEL
-  = SPRINKLER HEADER
-  = SPRINKLER RISER
-  = Bottle Filler



DATE REVISED	ADDRESS	Square Feet	BLDG NO	(PAT) PATTERSON HALL PENTHOUSE	FLOOR
02/08/2021	530 Quad LN		1175		4

DRAWINGS ARE NOT TO SCALE

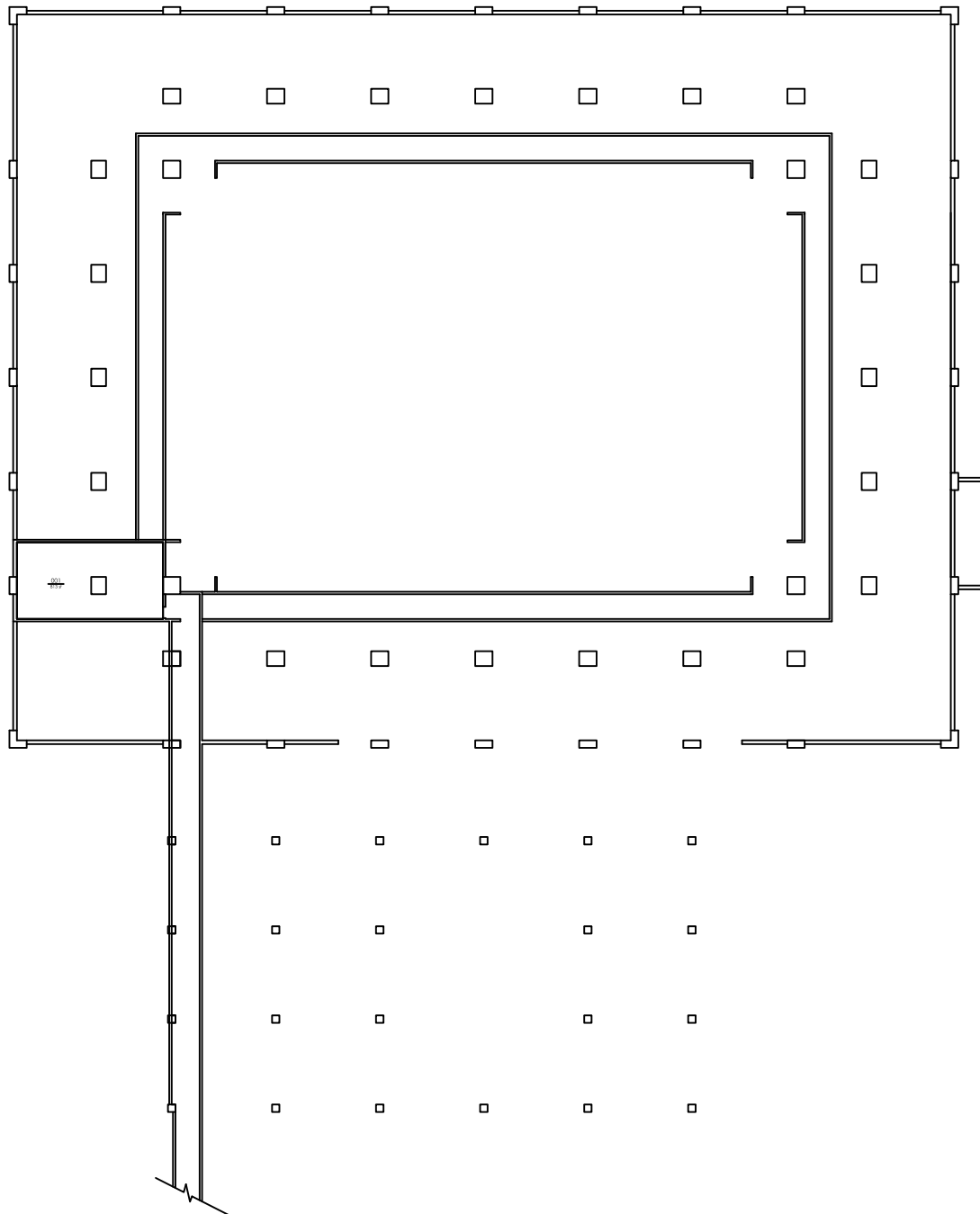

BASEMENT
PAVILION



 FICM Code 210 Classroom
 FICM Code 110 Classroom

 = FIRE EXTINGUISHER  = AED  = FIRE DEP. CONNECTION  = LOCK BOX  = FIRE ALARM CONTROL PANEL  = SPRINKLER HEADER **R** = SPRINKLER RISER  = Bottle Filler

DATE REVISED
10/21/2020

ADDRESS
1375 Swoop LN



Square Feet
813

BLDG NO
1345

(PAV) PAVILION
BASEMENT

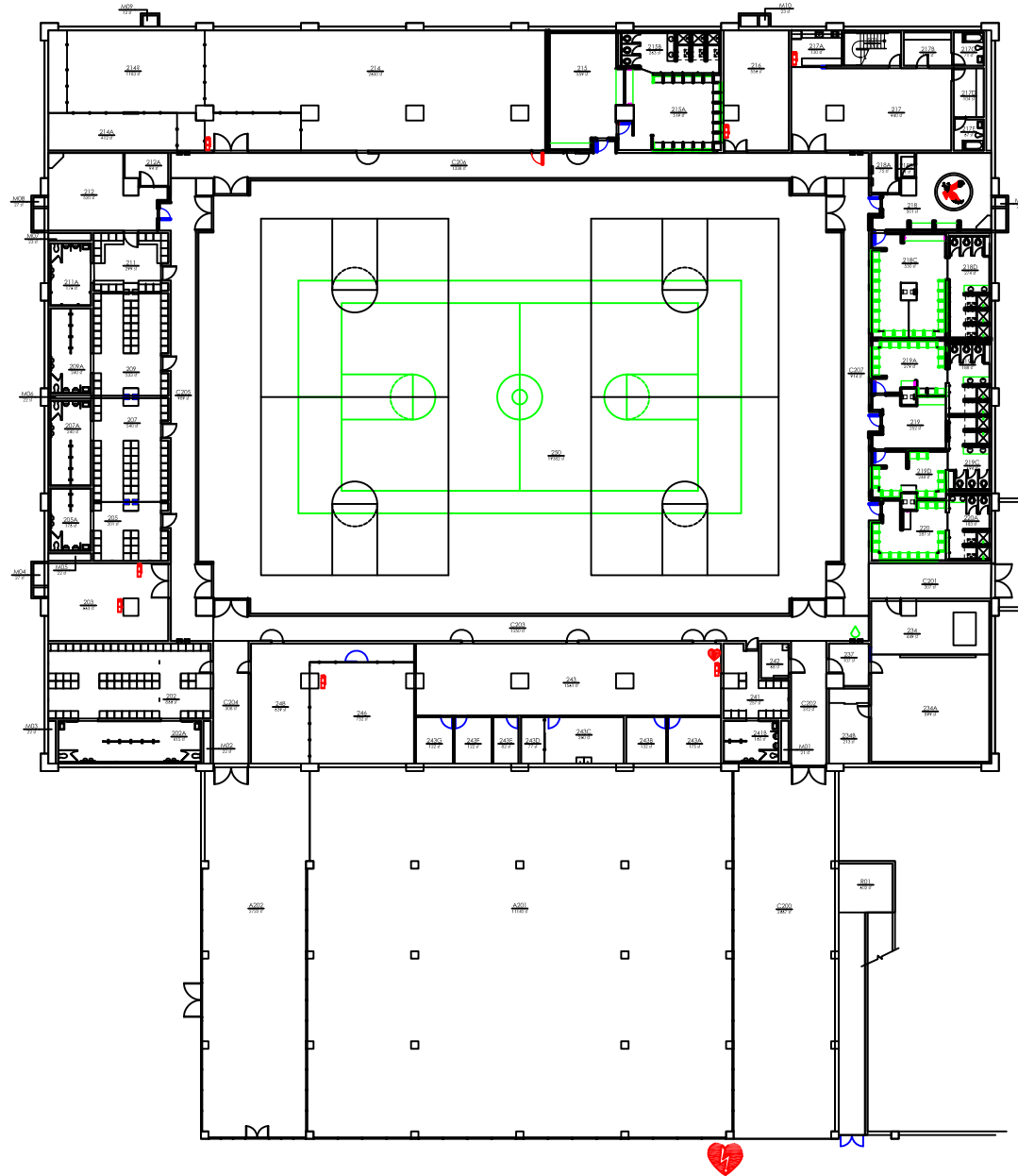
FLOOR
0



 FICM Code 210 Classroom
 FICM Code 110 Classroom



 = FIRE EXTINGUISHER  = AED  = FIRE DEP. CONNECTION  = LOCK BOX  = FIRE ALARM CONTROL PANEL  = SPRINKLER HEADER **R** = SPRINKLER RISER  = Bottle Filler

DATE REVISED 10/21/2020	ADDRESS 1375 Swoop LN	Square Feet 67747	BLDG NO 1345	(PAV) PAVILION FIRST FLOOR-COURT LEVEL	FLOOR 1
----------------------------	--------------------------	----------------------	-----------------	---	------------

DRAWINGS ARE NOT TO SCALE

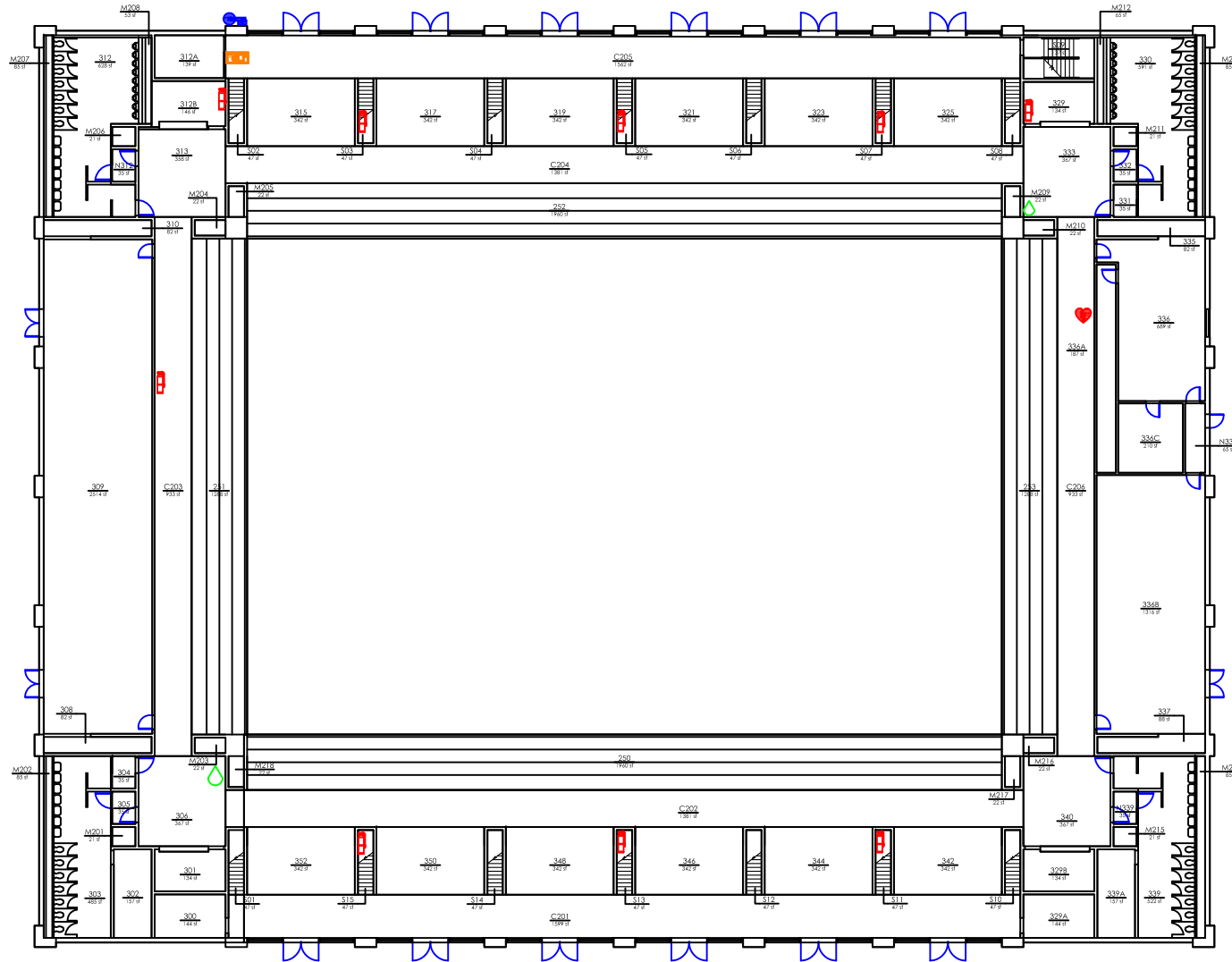
**SECOND FLOOR
PAVILION**



-  FICM Code 210 Classroom
-  FICM Code 110 Classroom

-  = FIRE EXTINGUISHER
-  = AED
-  = FIRE DEP. CONNECTION
-  = LOCK BOX
-  = FIRE ALARM CONTROL PANEL
-  = SPRINKLER HEADER
-  = SPRINKLER RISER
-  = Bottle Filler

DATE REVISED	ADDRESS	Square Feet	BLDG NO	(PAV) PAVILION SECOND FLOOR	FLOOR 2
10/21/2020	1375 Swoop LN	32601	1345		

DRAWINGS ARE NOT TO SCALE



THIRD FLOOR
PAVILION

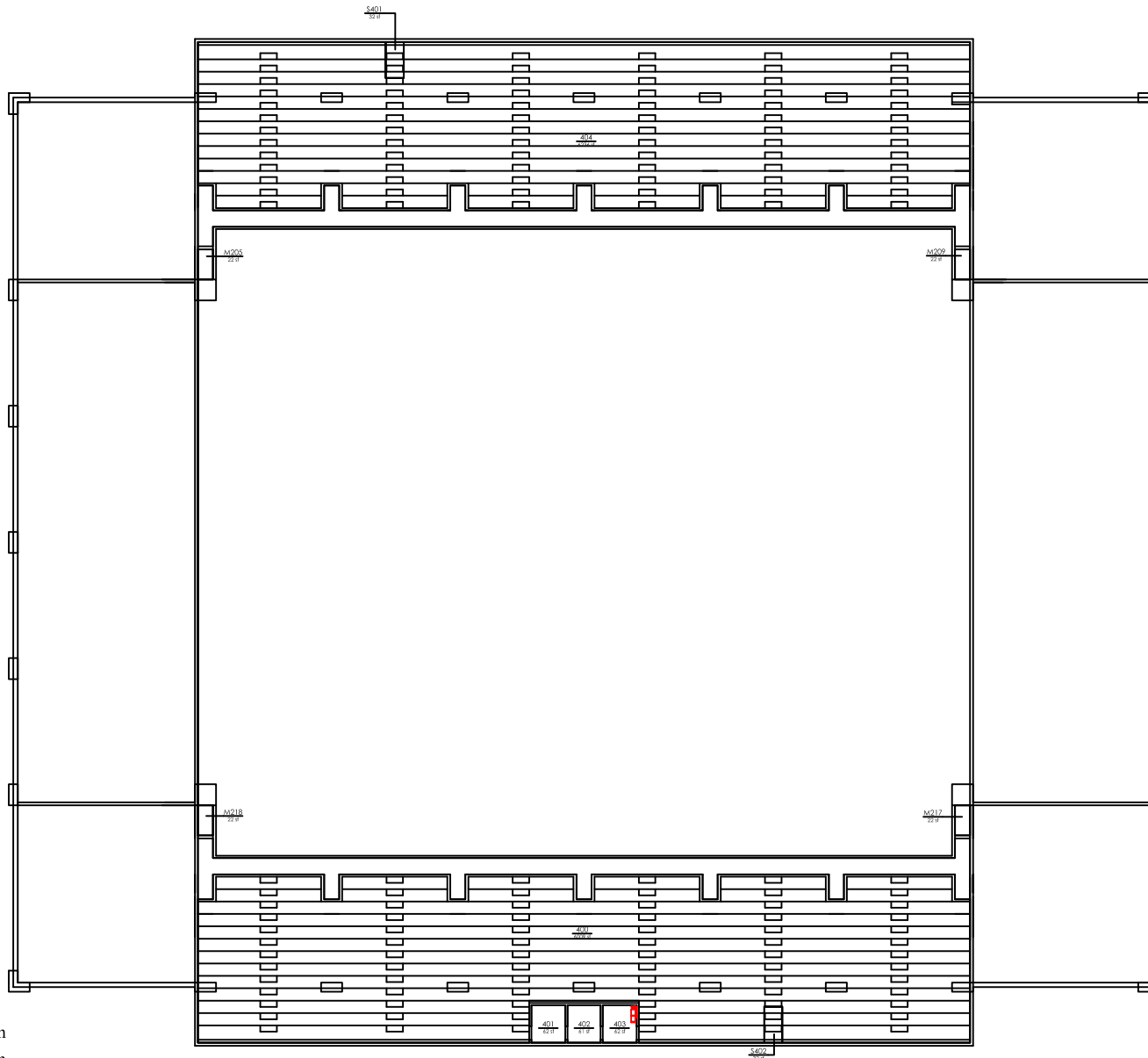

- FICM Code 210 Classroom
- FICM Code 110 Classroom

- = FIRE EXTINGUISHER
- = AED
- = FIRE DEP. CONNECTION
- = LOCK BOX
- = FIRE ALARM CONTROL PANEL
- = SPRINKLER HEADER
- = SPRINKLER RISER
- = Bottle Filler

DATE REVISED
10/21/2020

ADDRESS
1375 Swoop LN

Square Feet
14205



BLDG NO
1345

(PAV) PAVILION
THIRD FLOOR

FLOOR
3

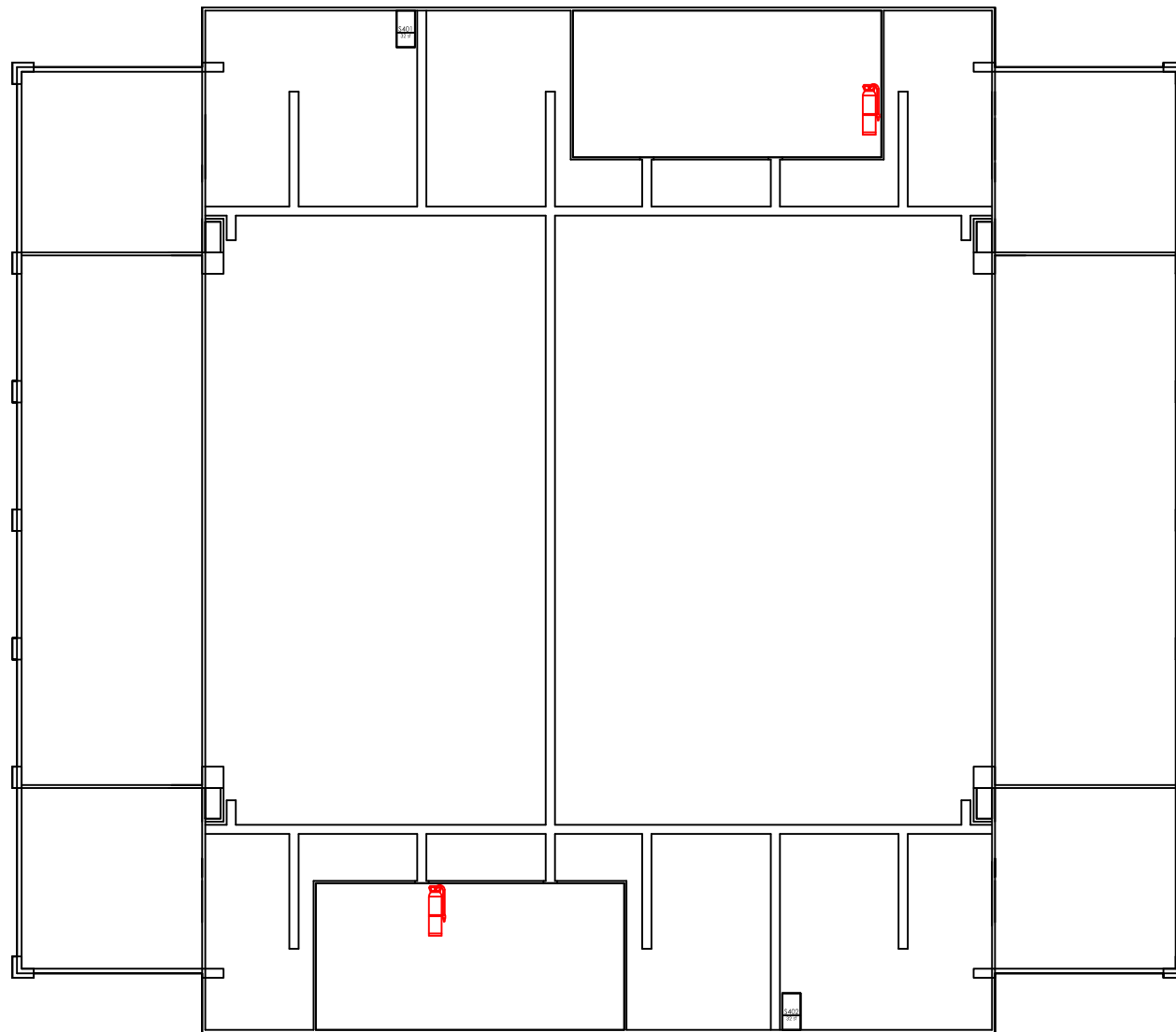
DRAWINGS ARE NOT TO SCALE



 FICM Code 210 Classroom
 FICM Code 110 Classroom

 = FIRE EXTINGUISHER  = AED  = FIRE DEP. CONNECTION  = LOCK BOX  = FIRE ALARM CONTROL PANEL  = SPRINKLER HEADER **R** = SPRINKLER RISER  = Bottle Filler

DATE REVISED 10/21/2020	ADDRESS 1375 Swoop LN	Square Feet 54560	BLDG NO 1345	(PAV) PAVILION FOURTH FLOOR	FLOOR 4
----------------------------	--------------------------	----------------------	-----------------	--------------------------------	------------

DRAWINGS ARE NOT TO SCALE

MAIN FLOOR
WOODWARD FIELD PRESSBOX

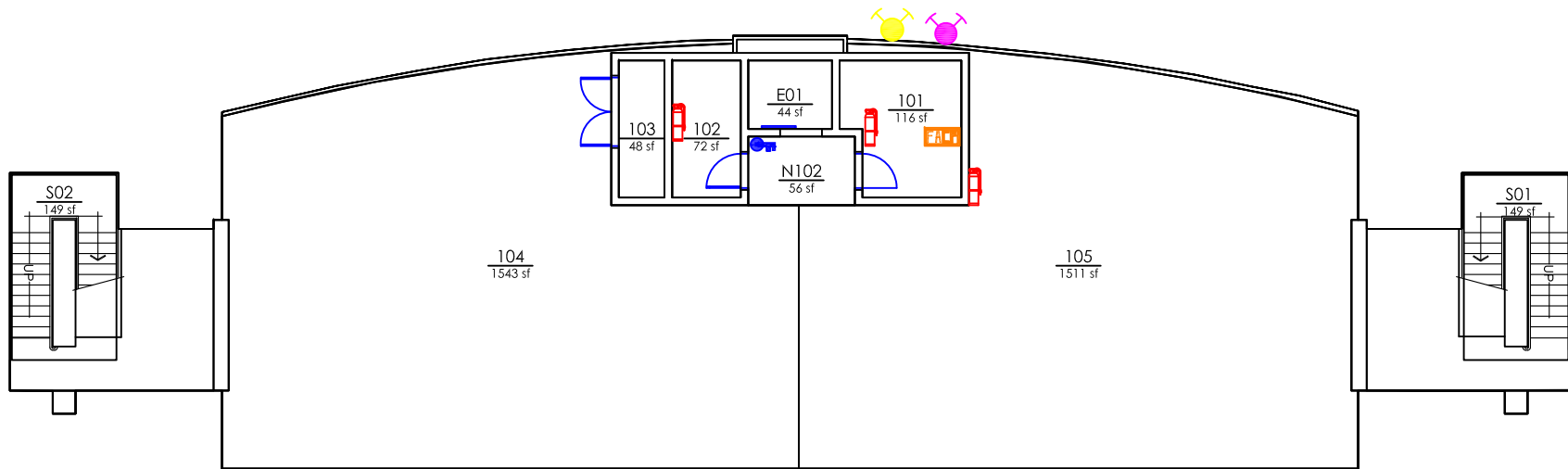



- FICM Code 210 Classroom
- FICM Code 110 Classroom

- = FIRE EXTINGUISHER
- = AED
- = FIRE DEP. CONNECTION
- = LOCK BOX
- = FIRE ALARM CONTROL PANEL
- = SPRINKLER HEADER
- = SPRINKLER RISER
- = Bottle Filler

DATE REVISED	ADDRESS	Square Feet	BLDG NO	(PBS) ROOS FIELD PRESSBOX FIRST FLOOR	FLOOR
10/21/2020	1281 Playfield LN	4166	1385		1

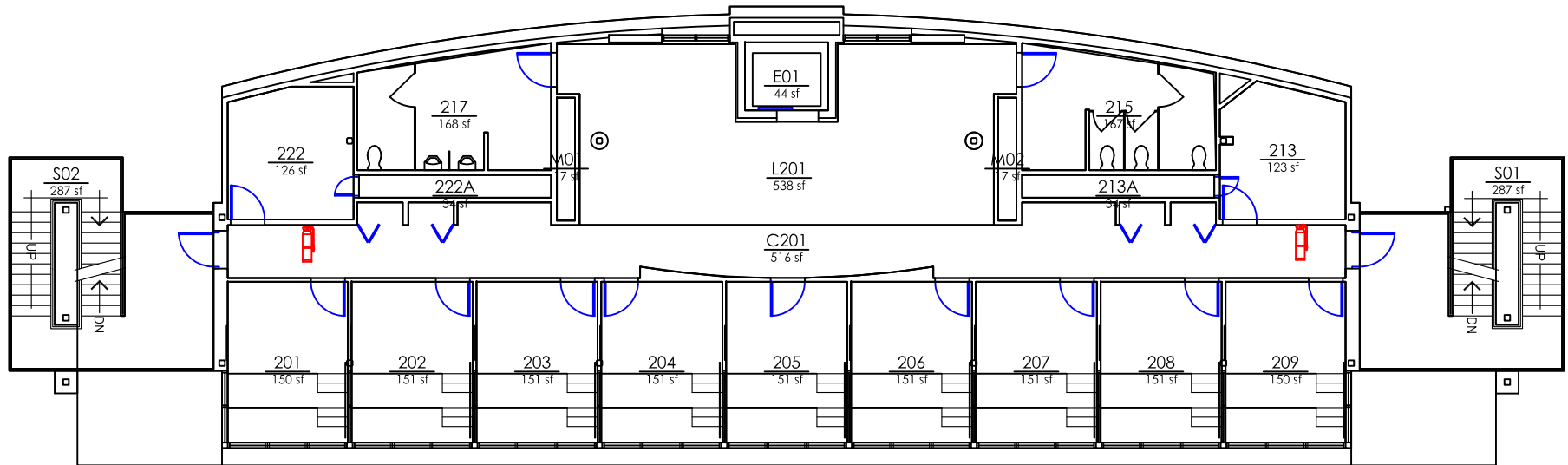
SECOND FLOOR
 WOODWARD FIELD PRESSBOX 



 FICM Code 210 Classroom
 FICM Code 110 Classroom

 = FIRE EXTINGUISHER  = AED  = FIRE DEP. CONNECTION  = LOCK BOX  = FIRE ALARM CONTROL PANEL  = SPRINKLER HEADER **R** = SPRINKLER RISER  = Bottle Filler

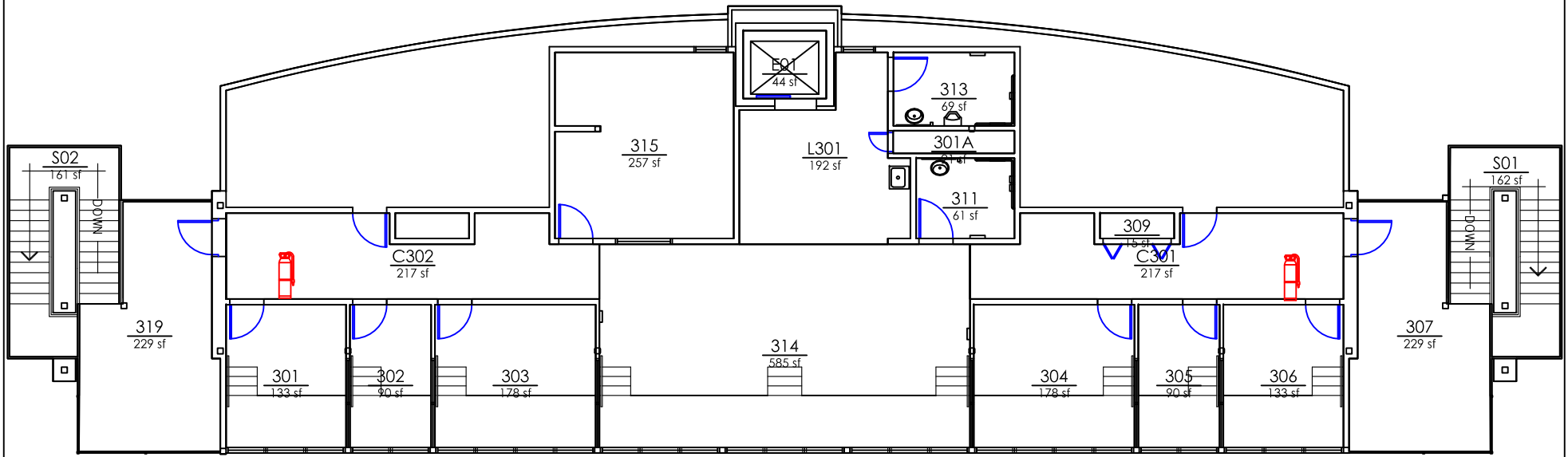

DATE REVISED	ADDRESS	Square Feet	BLDG NO	(PBS) ROOS FIELD PRESSBOX SECOND FLOOR	FLOOR 2
10/21/2020	1281 Playfield LN	4227	1385		

DRAWINGS ARE NOT TO SCALE



THIRD FLOOR
WOODWARD FIELD PRESSBOX



-  FICM Code 210 Classroom
-  FICM Code 110 Classroom

-  = FIRE EXTINGUISHER
-  = AED
-  = FIRE DEP. CONNECTION
-  = LOCK BOX
-  = FIRE ALARM CONTROL PANEL
-  = SPRINKLER HEADER
-  = SPRINKLER RISER
-  = Bottle Filler

DATE REVISED
10/21/2020

ADDRESS
1281 Playfield LN

Square Feet
4494

BLDG NO
1385

(PBS) ROOS FEILD PRESSBOX
THIRD FLOOR



FLOOR
3

DRAWINGS ARE NOT TO SCALE

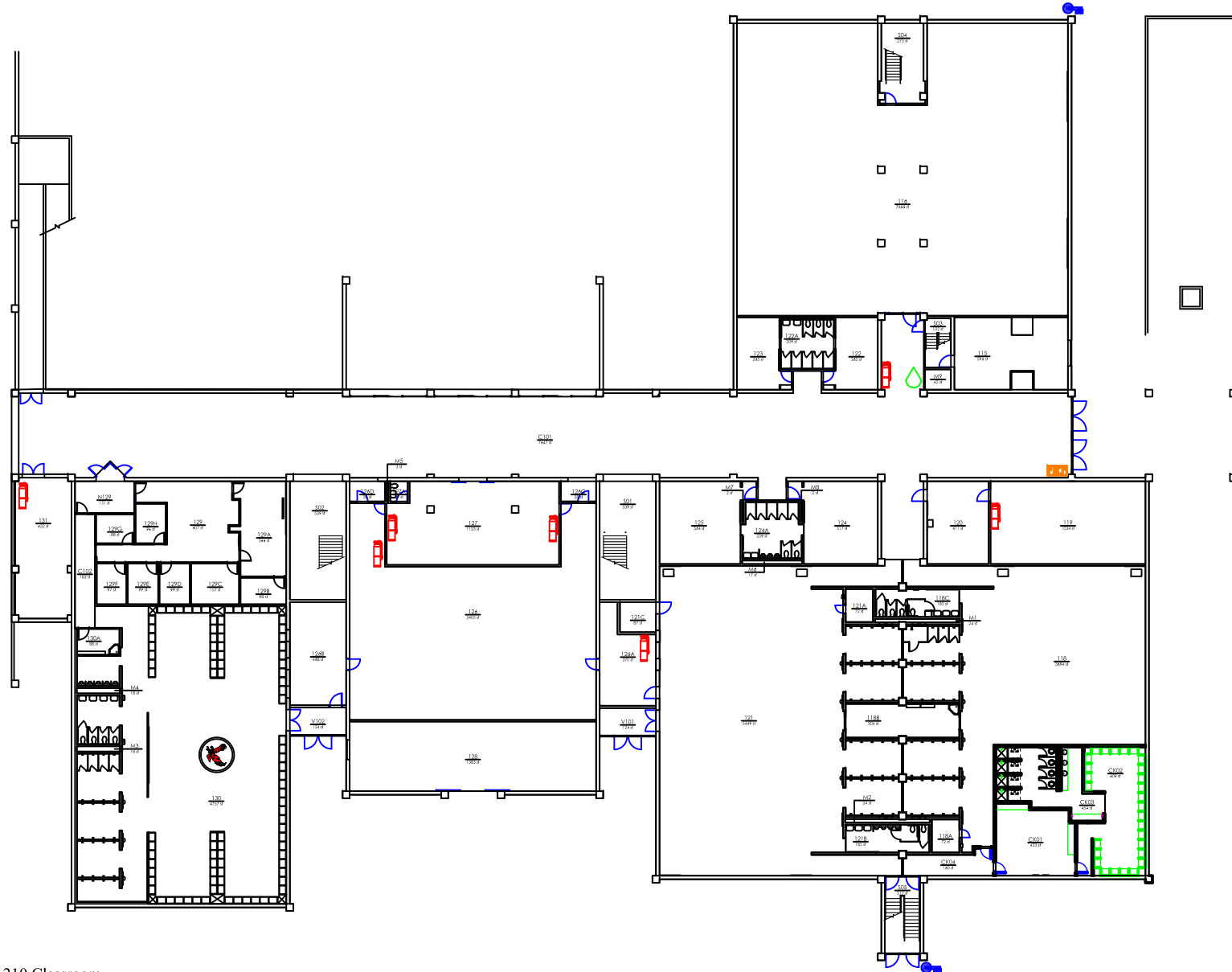

LOWER LEVEL
P. E. ACTIVITIES



 FICM Code 210 Classroom
 FICM Code 110 Classroom

 = FIRE EXTINGUISHER  = AED  = FIRE DEP. CONNECTION  = LOCK BOX  = FIRE ALARM CONTROL PANEL  = SPRINKLER HEADER **R** = SPRINKLER RISER  = Bottle Filler

DATE REVISED
10/05/2020

ADDRESS
1275 Swoop LN

Square Feet
50974

BLDG NO
1303

(PEA) P.E. ACTIVITIES
LOWER FLOOR

FLOOR
1

DRAWINGS ARE NOT TO SCALE



UPPER FLOOR
P. E. ACTIVITIES

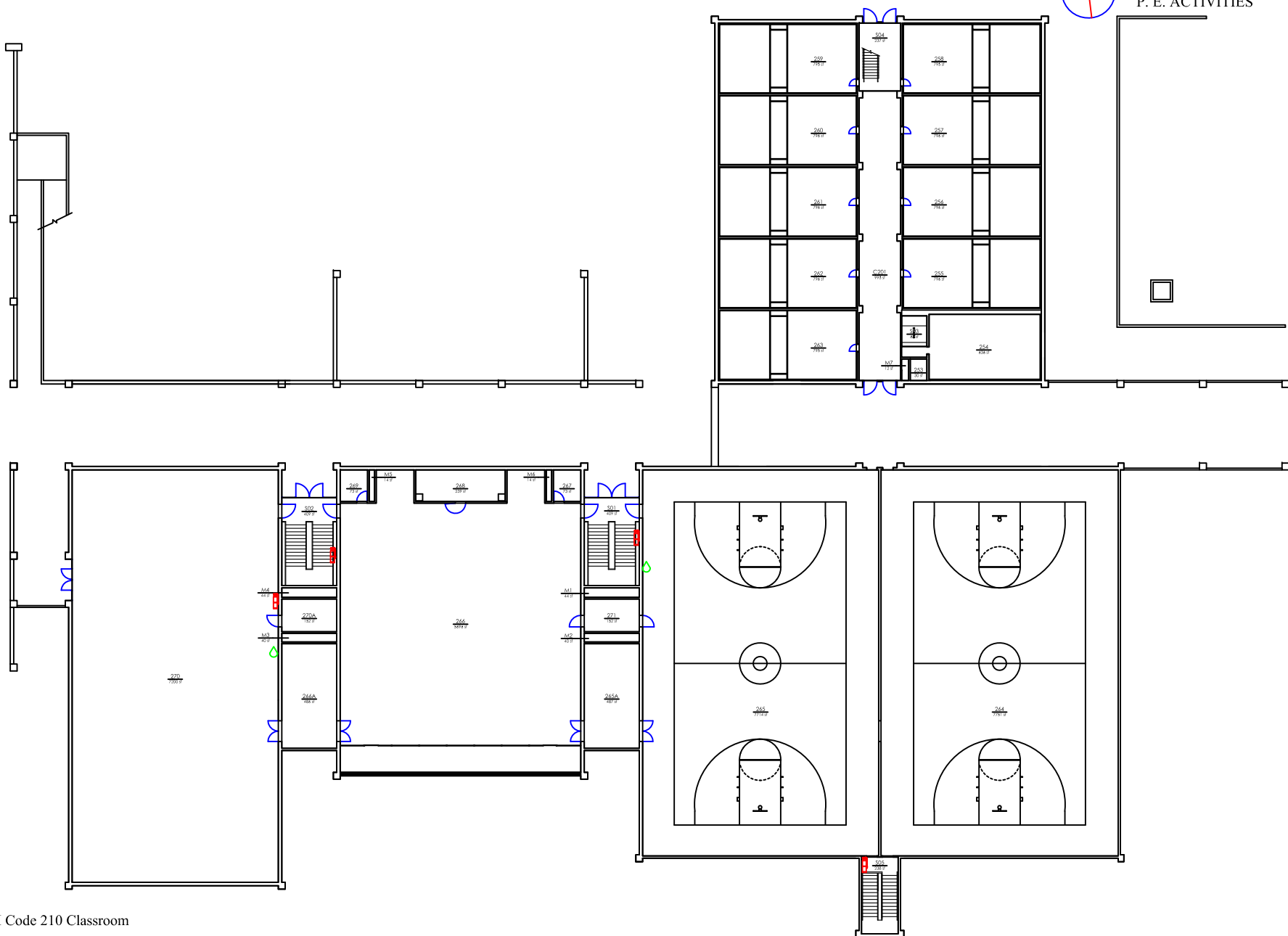

- FICM Code 210 Classroom
- FICM Code 110 Classroom

- = FIRE EXTINGUISHER
- = AED
- = FIRE DEP. CONNECTION
- = LOCK BOX
- = FIRE ALARM CONTROL PANEL
- = SPRINKLER HEADER
- R** = SPRINKLER RISER
- = Bottle Filler

DATE REVISED
10/05/2020

ADDRESS
1275 Swoop LN

Square Feet
42885

BLDG NO
1303



(PEA) P.E. ACTIVITIES
UPPER FLOOR

FLOOR
2

DRAWINGS ARE NOT TO SCALE

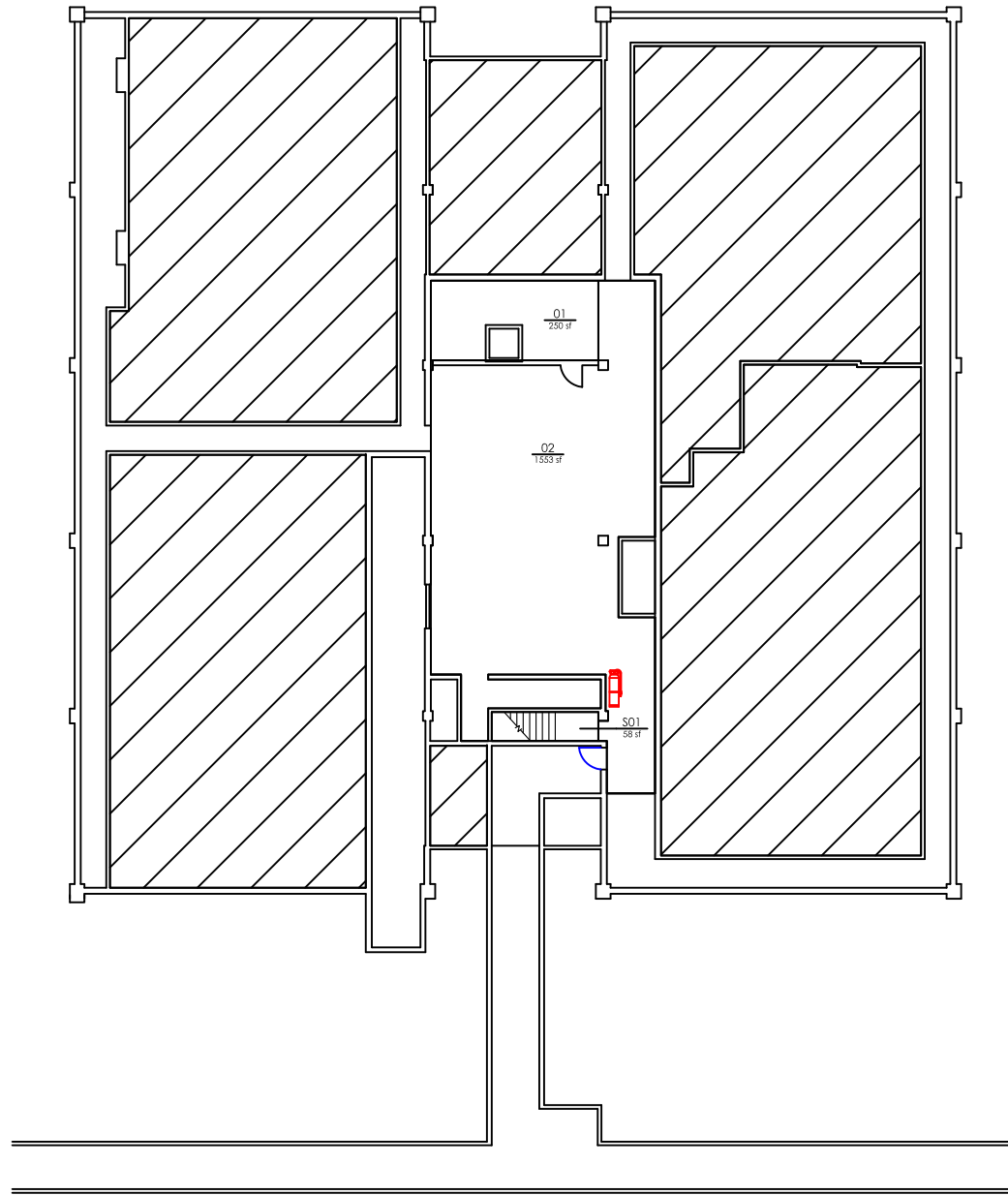
BASEMENT
P.E. CLASSROOM



-  FICM Code 210 Classroom
-  FICM Code 110 Classroom

-  = FIRE EXTINGUISHER
-  = AED
-  = FIRE DEP. CONNECTION
-  = LOCK BOX
-  = FIRE ALARM CONTROL PANEL
-  = SPRINKLER HEADER
-  = SPRINKLER RISER
-  = Bottle Filler

DATE REVISED 08/07/2020	ADDRESS 1106 Washington Street	Square Feet 1942	BLDG NO 1325	(PEC) P.E. CLASSROOM BASEMENT	FLOOR 0
----------------------------	-----------------------------------	---------------------	-----------------	----------------------------------	------------

DRAWINGS ARE NOT TO SCALE

FIRST FLOOR
P.E. CLASSROOM

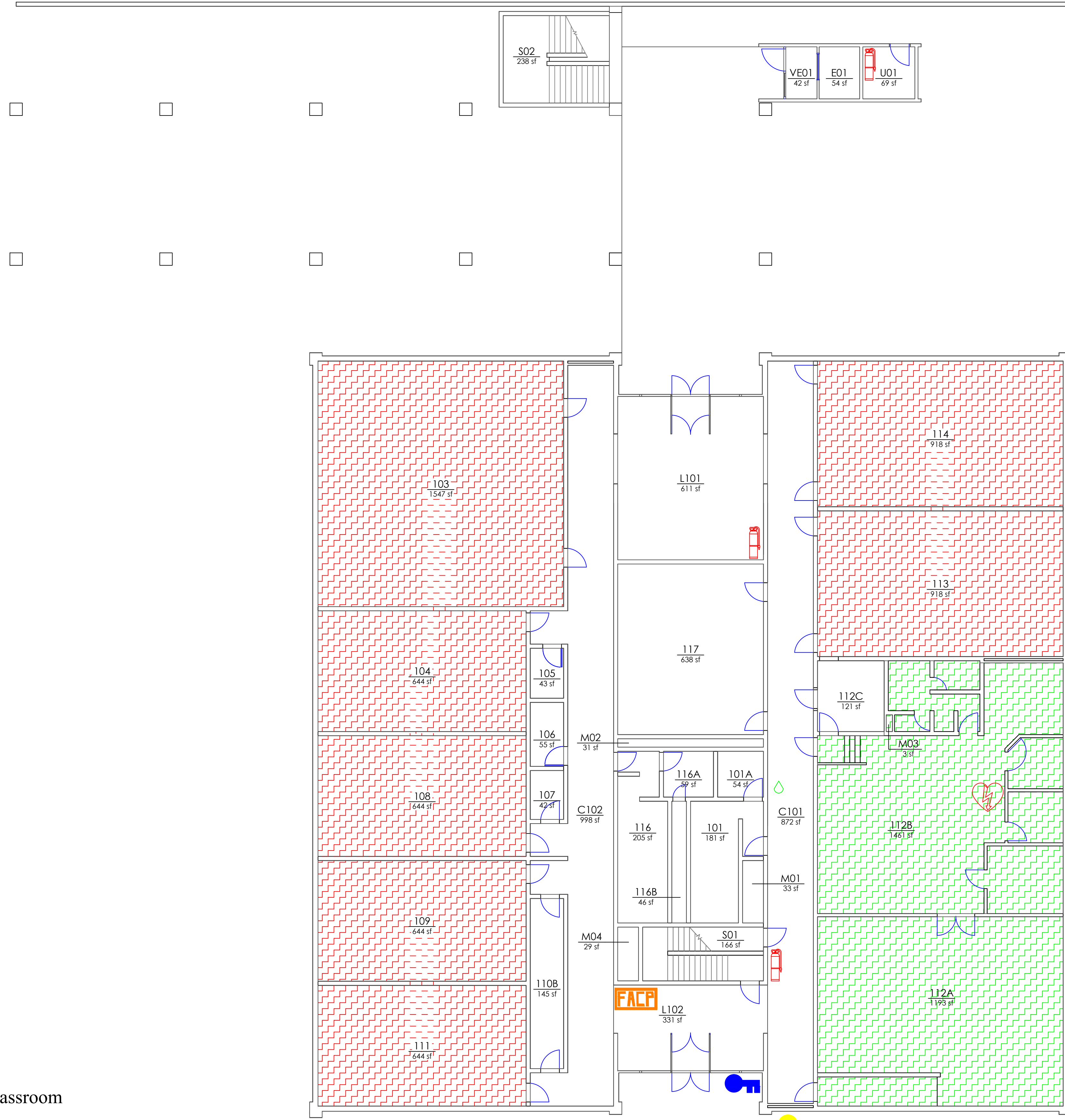
 FICM Code 210 Classroom
 FICM Code 110 Classroom

 = FIRE EXTINGUISHER  = AED  = FIRE DEP. CONNECTION  = LOCK BOX  = FIRE ALARM CONTROL PANEL  = SPRINKLER HEADER  = SPRINKLER RISER  = Bottle Filler

DATE REVISED 02/01/2022	ADDRESS 1106 Washington Street	Square Feet 14884	BLDG NO 1325	(PEC) P.E CLASSROOM FIRST FLOOR	FLOOR 1
-----------------------------------	--	-----------------------------	------------------------	--	-------------------

DRAWINGS ARE NOT TO SCALE

SECOND FLOOR
P.E. CLASSROOM





- FICM Code 210 Classroom
- FICM Code 110 Classroom

- = FIRE EXTINGUISHER
- = AED
- = FIRE DEP. CONNECTION
- = LOCK BOX
- = FIRE ALARM CONTROL PANEL
- = SPRINKLER HEADER
- = SPRINKLER RISER
- = Bottle Filler

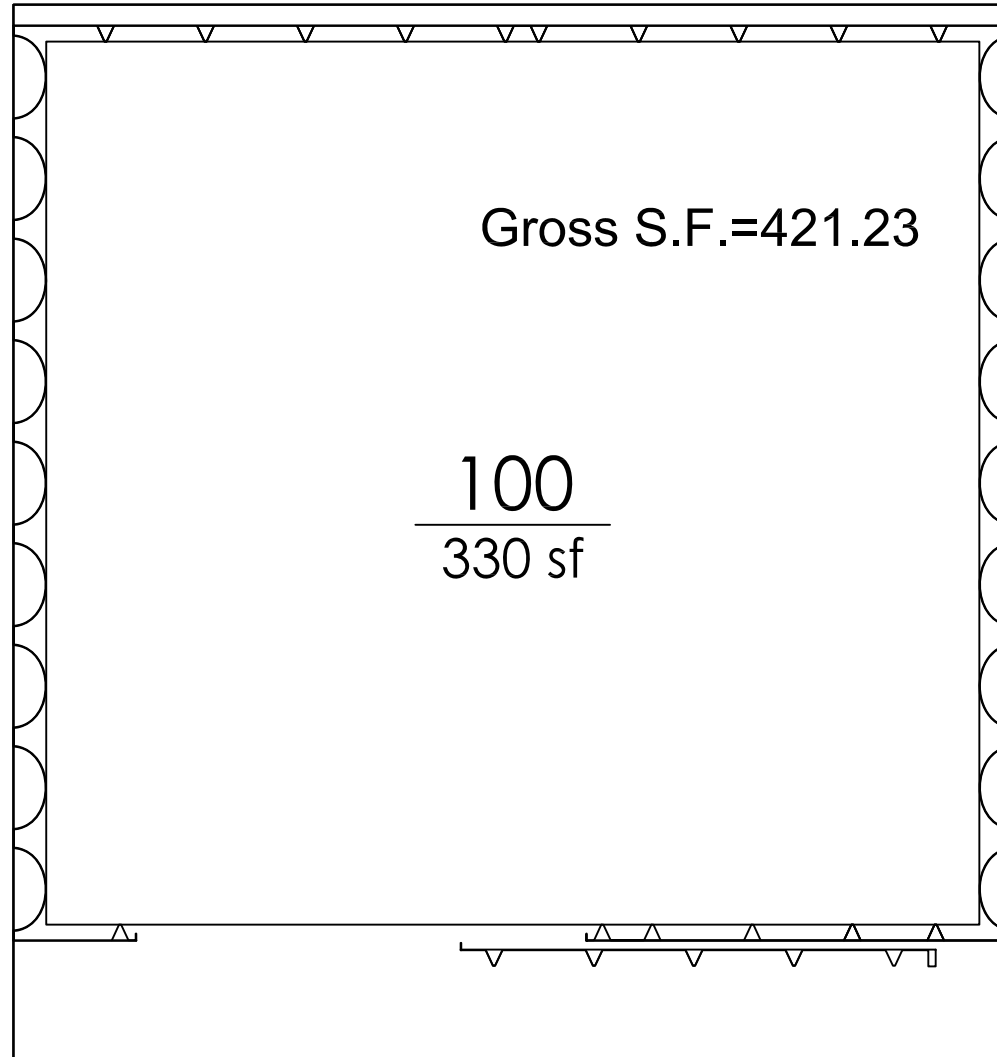
DATE REVISED 08/11/2020	ADDRESS 1106 Washington Street	Square Feet 15022	BLDG NO 1325	(PEC) P.E. CLASSROOM SECOND FLOOR	FLOOR 2
----------------------------	-----------------------------------	----------------------	-----------------	--------------------------------------	------------





-  FICM Code 210 Classroom
-  FICM Code 110 Classroom

-  = FIRE EXTINGUISHER
-  = AED
-  = FIRE DEP. CONNECTION
-  = LOCK BOX
-  = FIRE ALARM CONTROL PANEL
-  = SPRINKLER HEADER
-  = SPRINKLER RISER
-  = Bottle Filler

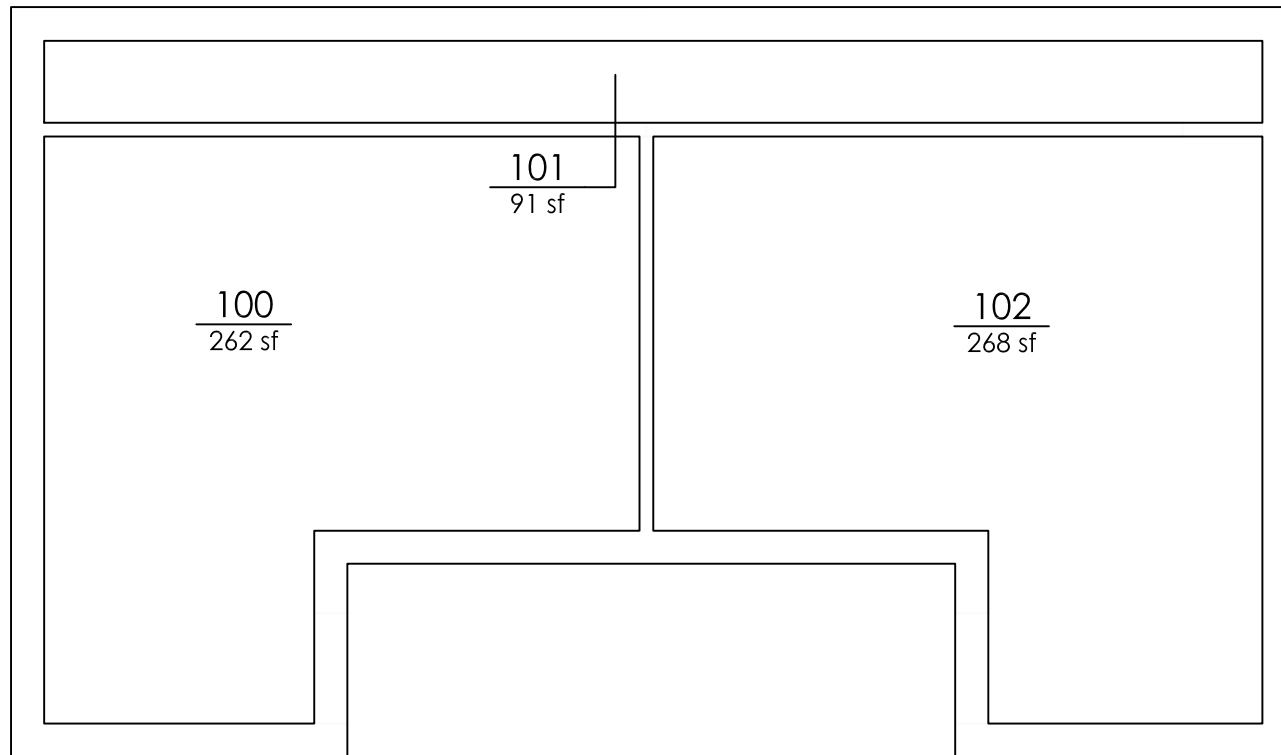
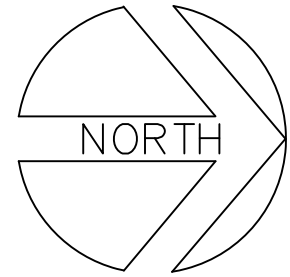
DATE REVISED 10/22/2020	ADDRESS 1124 Playfield LN	Square Feet	BLDG NO 1375	(PES) P.E. STORAGE	FLOOR 1
----------------------------	------------------------------	-------------	-----------------	--------------------	------------



 FICM Code 210 Classroom
 FICM Code 110 Classroom

 = FIRE EXTINGUISHER  = AED  = FIRE DEP. CONNECTION  = LOCK BOX  = FIRE ALARM CONTROL PANEL  = SPRINKLER HEADER **R** = SPRINKLER RISER  = Bottle Filler

DATE REVISED	ADDRESS	Square Feet	BLDG NO	(PLT) PRACTICE FIELD TOILETS FLOOR PLAN		FLOOR
10/22/2020	1140 Playfield LN	773	1395			1

DRAWINGS ARE NOT TO SCALE



**BASEMENT
PLANT UTILITIES**

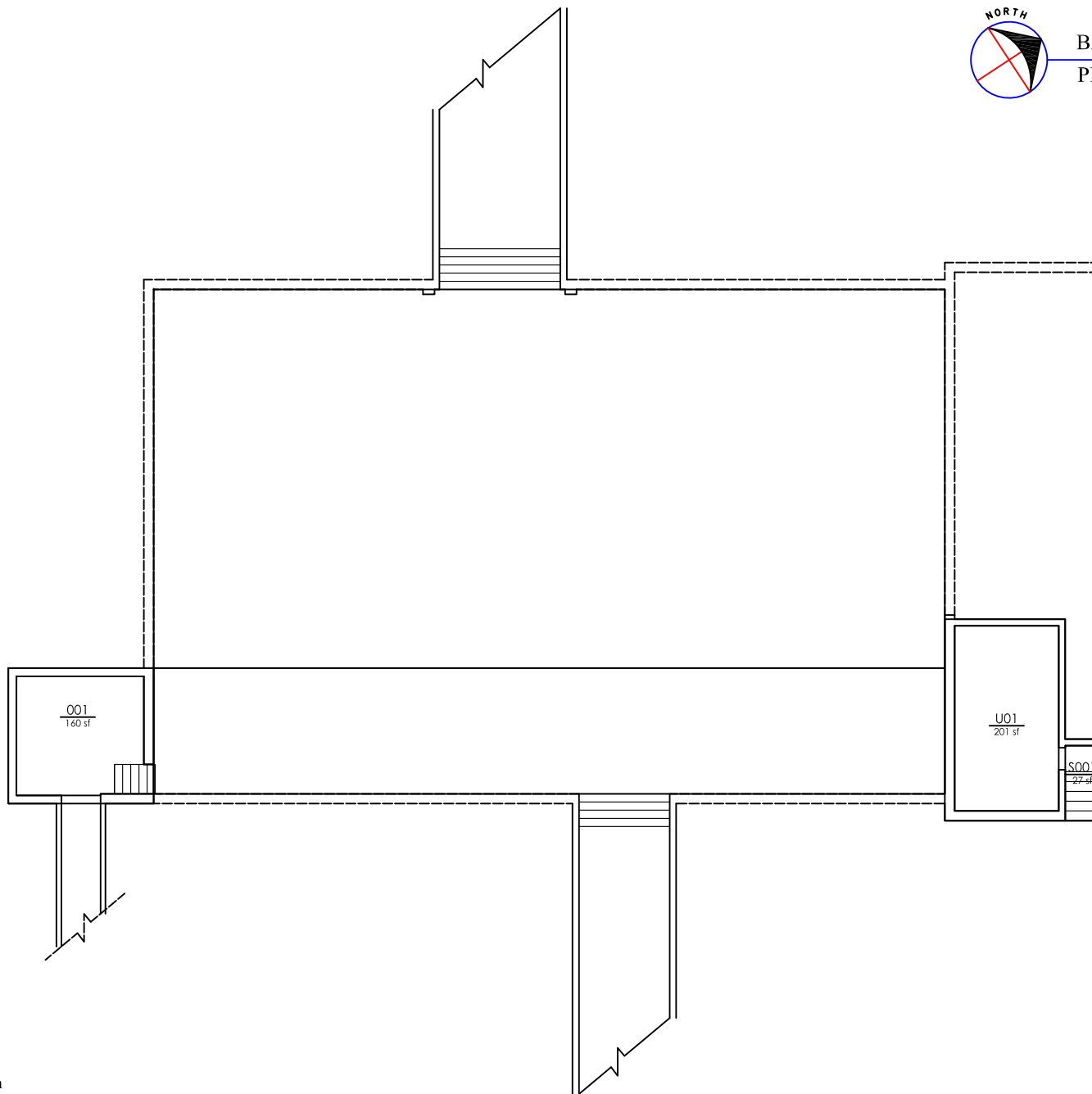

- FICM Code 210 Classroom
- FICM Code 110 Classroom

- = FIRE EXTINGUISHER
- = AED
- = FIRE DEP. CONNECTION
- = LOCK BOX
- = FIRE ALARM CONTROL PANEL
- = SPRINKLER HEADER
- = SPRINKLER RISER
- = Bottle Filler

DATE REVISED
10/22/2020

ADDRESS
515 Study LN

Square Feet
493

BLDG NO
1106

(PLU) PLANT UTILITIES
BASEMENT



FLOOR
0

DRAWINGS ARE NOT TO SCALE

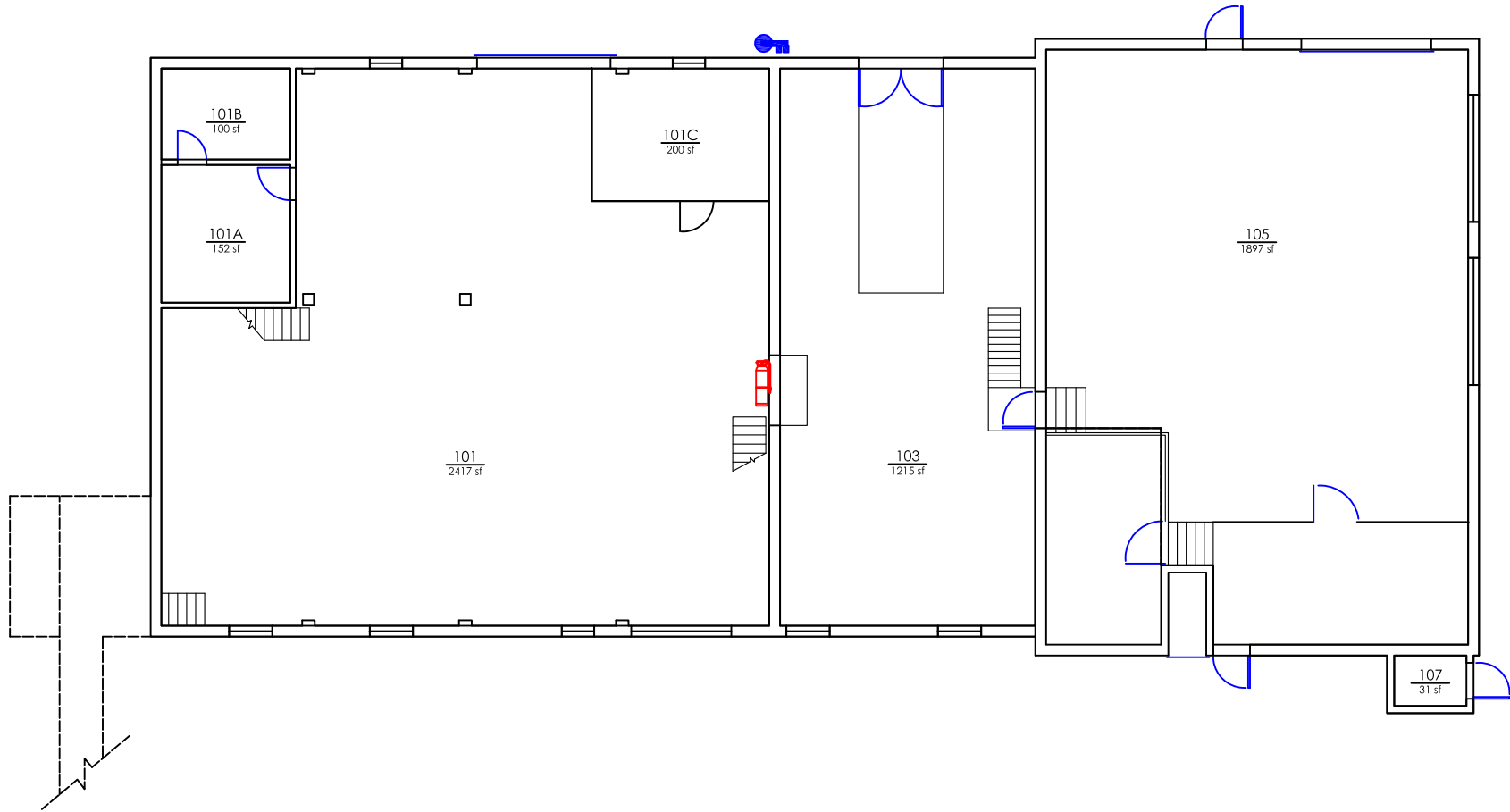

MAIN FLOOR
PLANT UTILITIES



 FICM Code 210 Classroom
 FICM Code 110 Classroom

 = FIRE EXTINGUISHER  = AED  = FIRE DEP. CONNECTION  = LOCK BOX  = FIRE ALARM CONTROL PANEL  = SPRINKLER HEADER  = SPRINKLER RISER  = Bottle Filler

DATE REVISED
10/22/2020

ADDRESS
515 Study LN

Square Feet
6469

BLDG NO
1106

(PLU) PLANT UTILITIES
FIRST FLOOR

FLOOR
1

DRAWINGS ARE NOT TO SCALE



SECOND FLOOR
PLANT UTILITIES

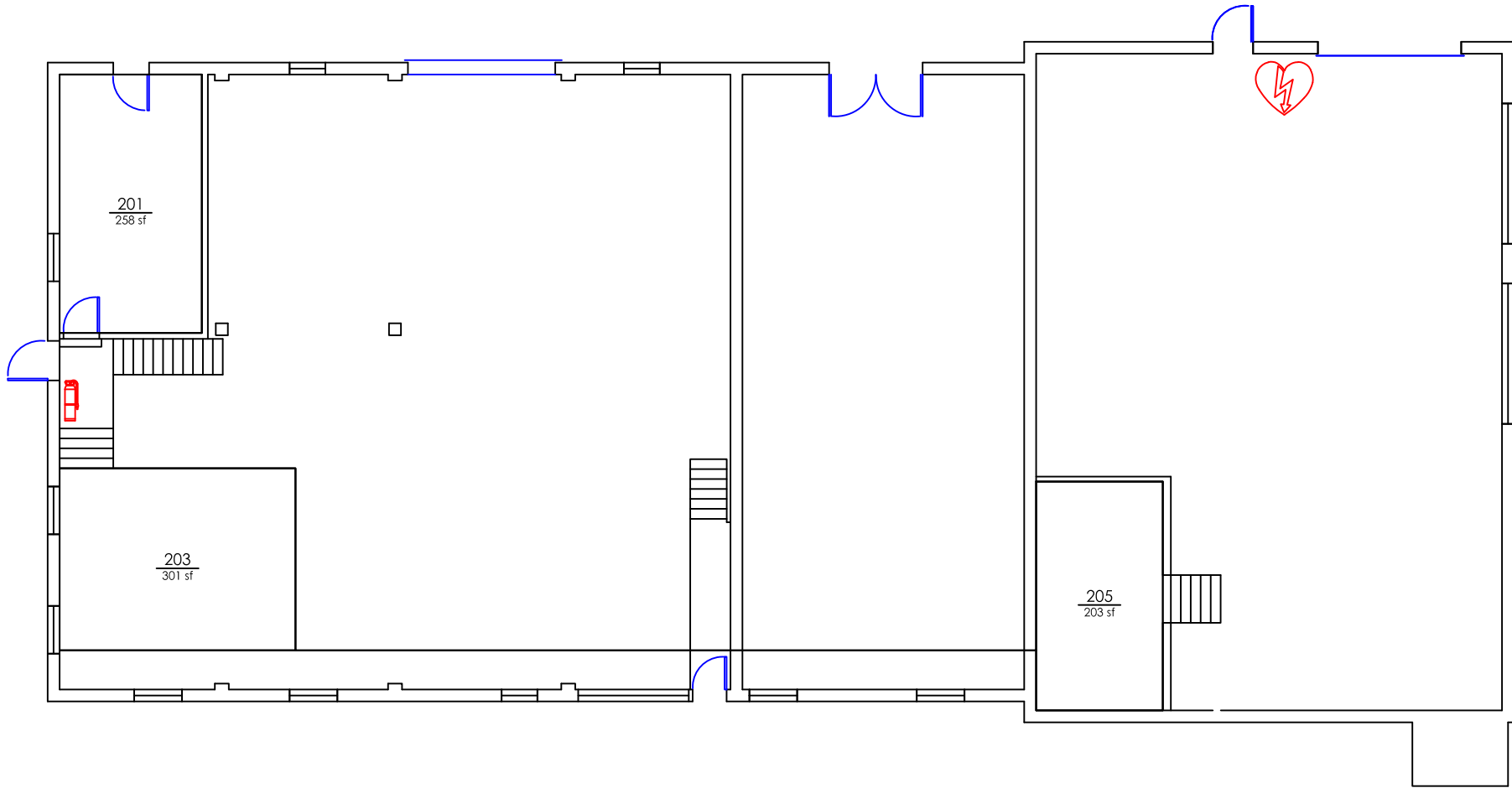

- FICM Code 210 Classroom
- FICM Code 110 Classroom

- = FIRE EXTINGUISHER
- = AED
- = FIRE DEP. CONNECTION
- = LOCK BOX
- = FIRE ALARM CONTROL PANEL
- = SPRINKLER HEADER
- = SPRINKLER RISER
- = Bottle Filler

DATE REVISED
10/22/2020

ADDRESS
515 Study LN

Square Feet
762

BLDG NO
1106



(PLU) PLANT UTILITIES
SECOND FLOOR

FLOOR
2

DRAWINGS ARE NOT TO SCALE

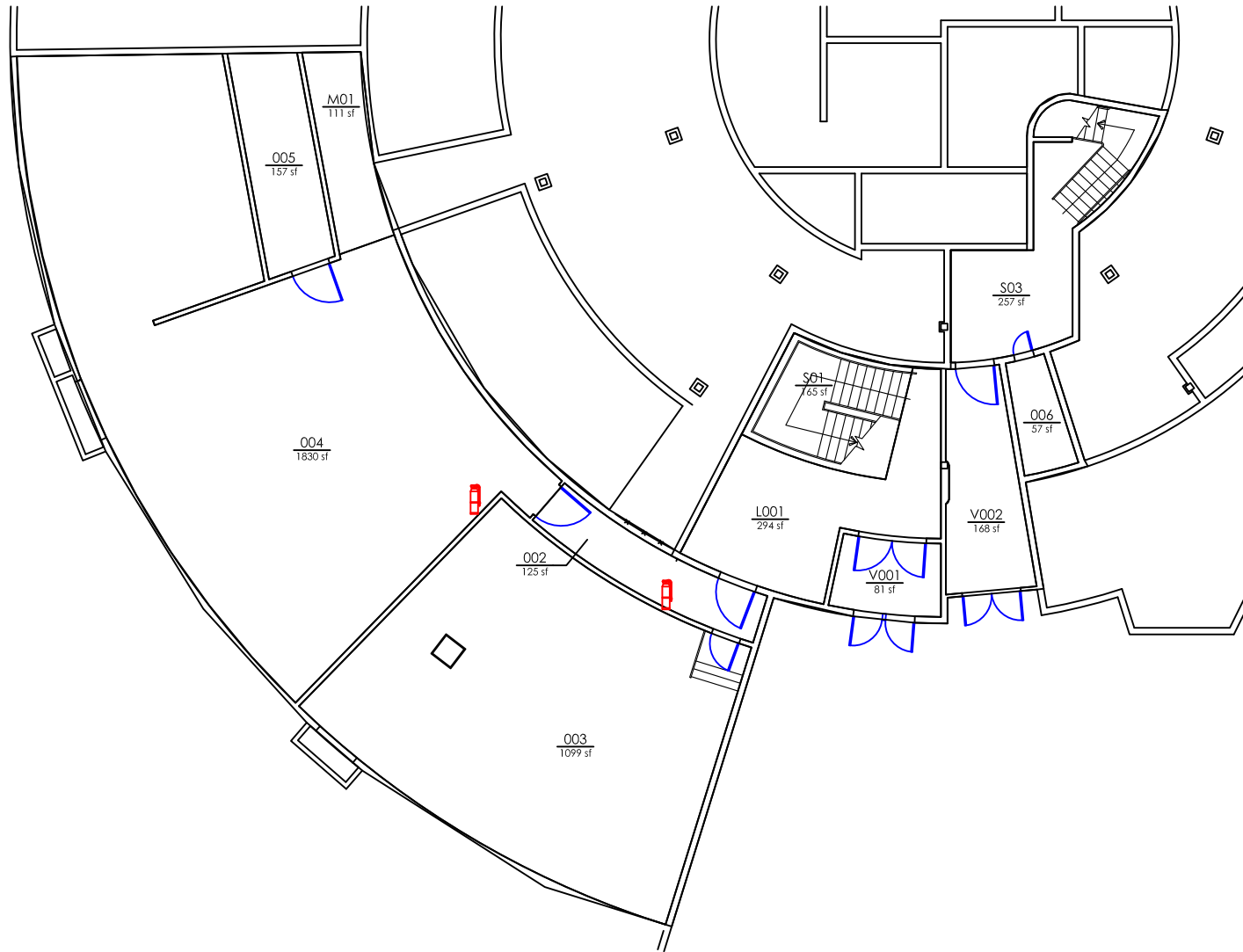
BASEMENT & ENTRY FLOOR
PEARCE HALL



-  FICM Code 210 Classroom
-  FICM Code 110 Classroom



-  = FIRE EXTINGUISHER
-  = AED
-  = FIRE DEP. CONNECTION
-  = LOCK BOX
-  = FIRE ALARM CONTROL PANEL
-  = SPRINKLER HEADER
-  = SPRINKLER RISER
-  = Bottle Filler

DATE REVISED	ADDRESS	Square Feet	BLDG NO	(PRC) PEARCE HALL BASEMENT ENTRY FLOOR	FLOOR
10/23/2020	1112 Elm Street	4640	1170		0

DRAWINGS ARE NOT TO SCALE

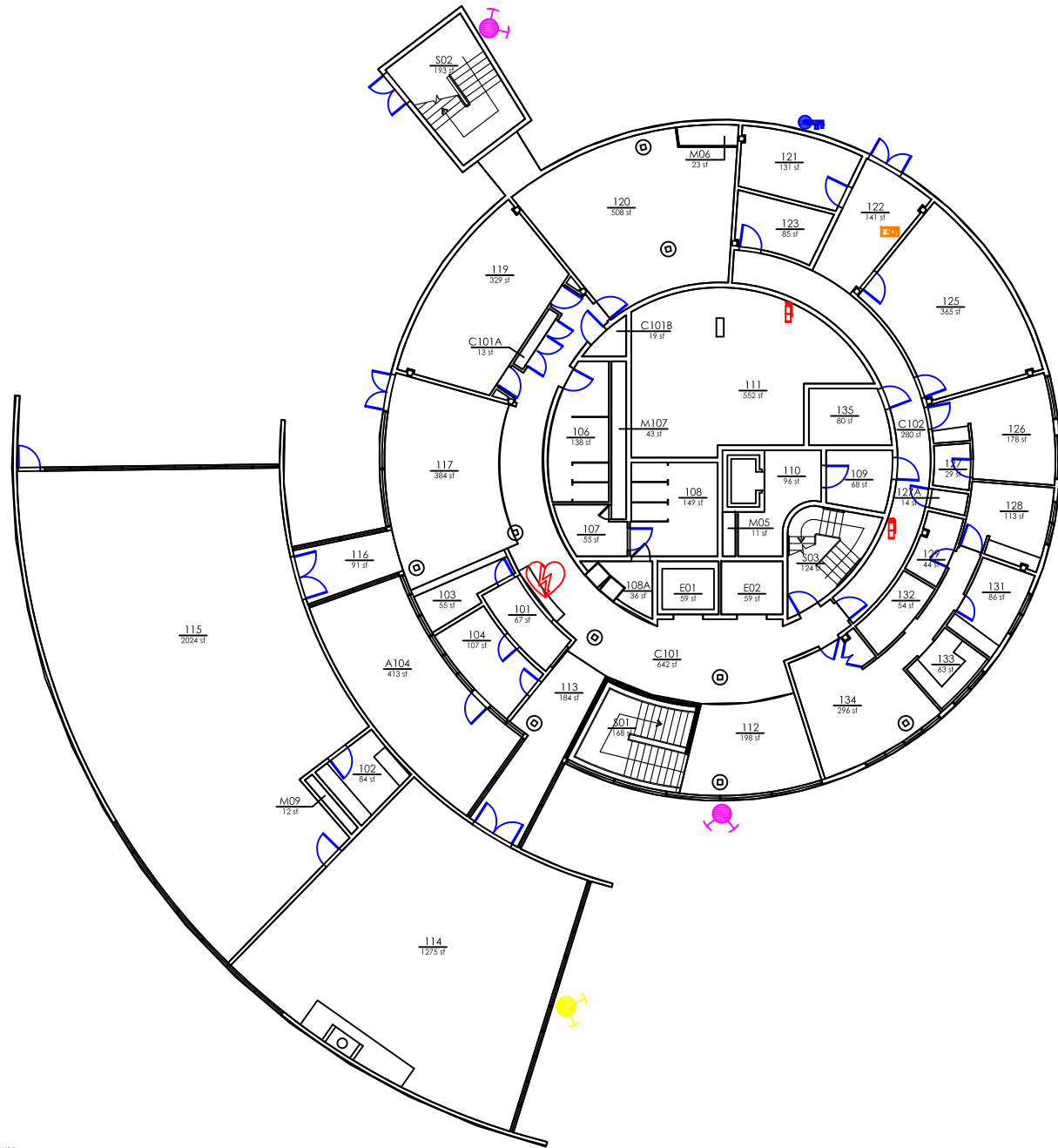
FIRST FLOOR
PEARCE HALL 



 FICM Code 210 Classroom
 FICM Code 110 Classroom



 = FIRE EXTINGUISHER  = AED  = FIRE DEP. CONNECTION  = LOCK BOX  = FIRE ALARM CONTROL PANEL  = SPRINKLER HEADER **R** = SPRINKLER RISER  = Bottle Filler

DATE REVISED 10/23/2020	ADDRESS 1112 Elm Street	Square Feet 11108	BLDG NO 1170	(PRC) PEARCE HALL FIRST FLOOR	FLOOR 1
----------------------------	----------------------------	----------------------	-----------------	----------------------------------	------------

DRAWINGS ARE NOT TO SCALE

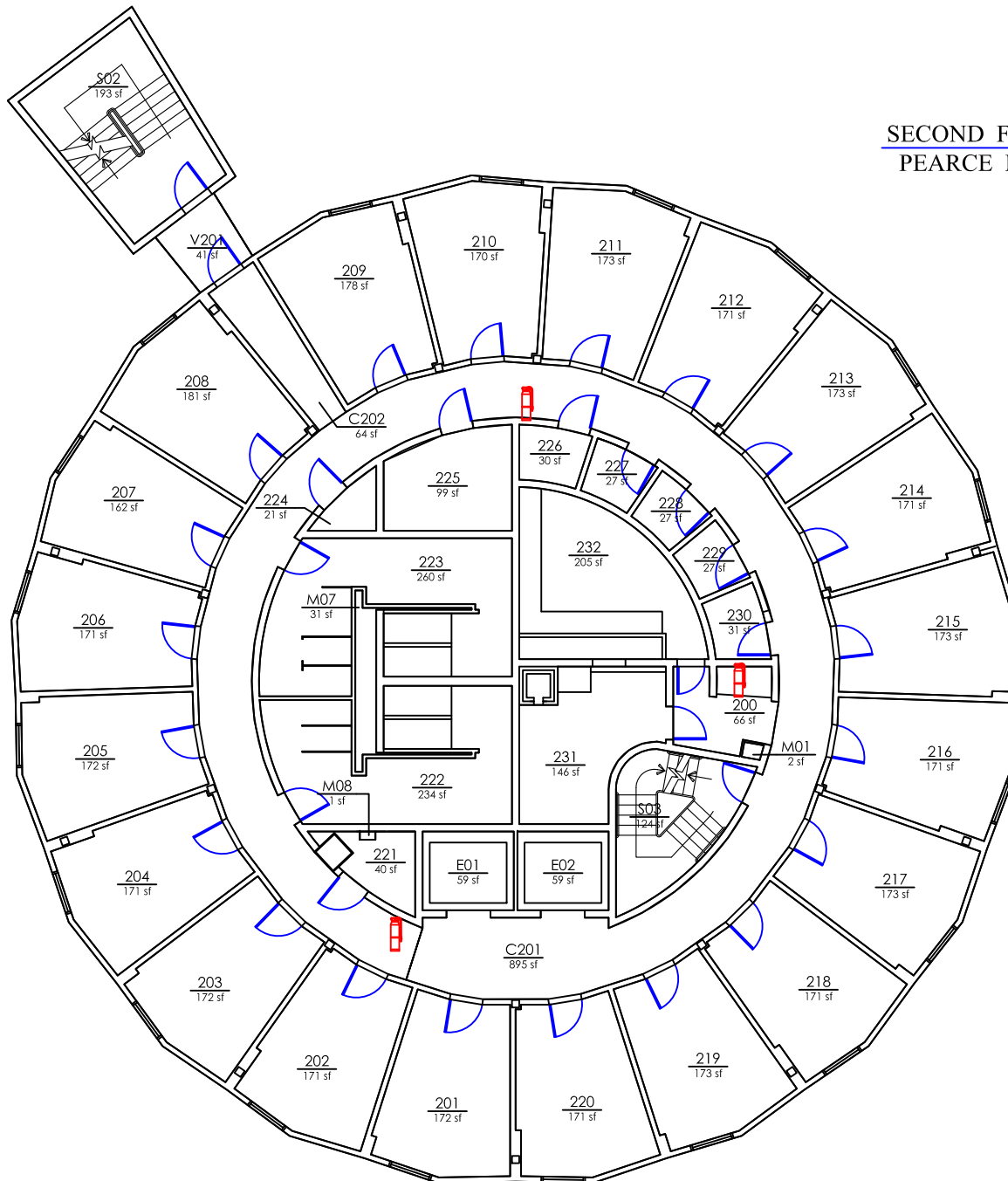
SECOND FLOOR
PEARCE HALL 





-  FICM Code 210 Classroom
-  FICM Code 110 Classroom

-  = FIRE EXTINGUISHER
-  = AED
-  = FIRE DEP. CONNECTION
-  = LOCK BOX
-  = FIRE ALARM CONTROL PANEL
-  = SPRINKLER HEADER
-  = SPRINKLER RISER
-  = Bottle Filler

DATE REVISED	ADDRESS	Square Feet	BLDG NO	(PRC) PEARCE HALL SECOND FLOOR	FLOOR
10/23/2020	1112 Elm Street	6845	1170		2

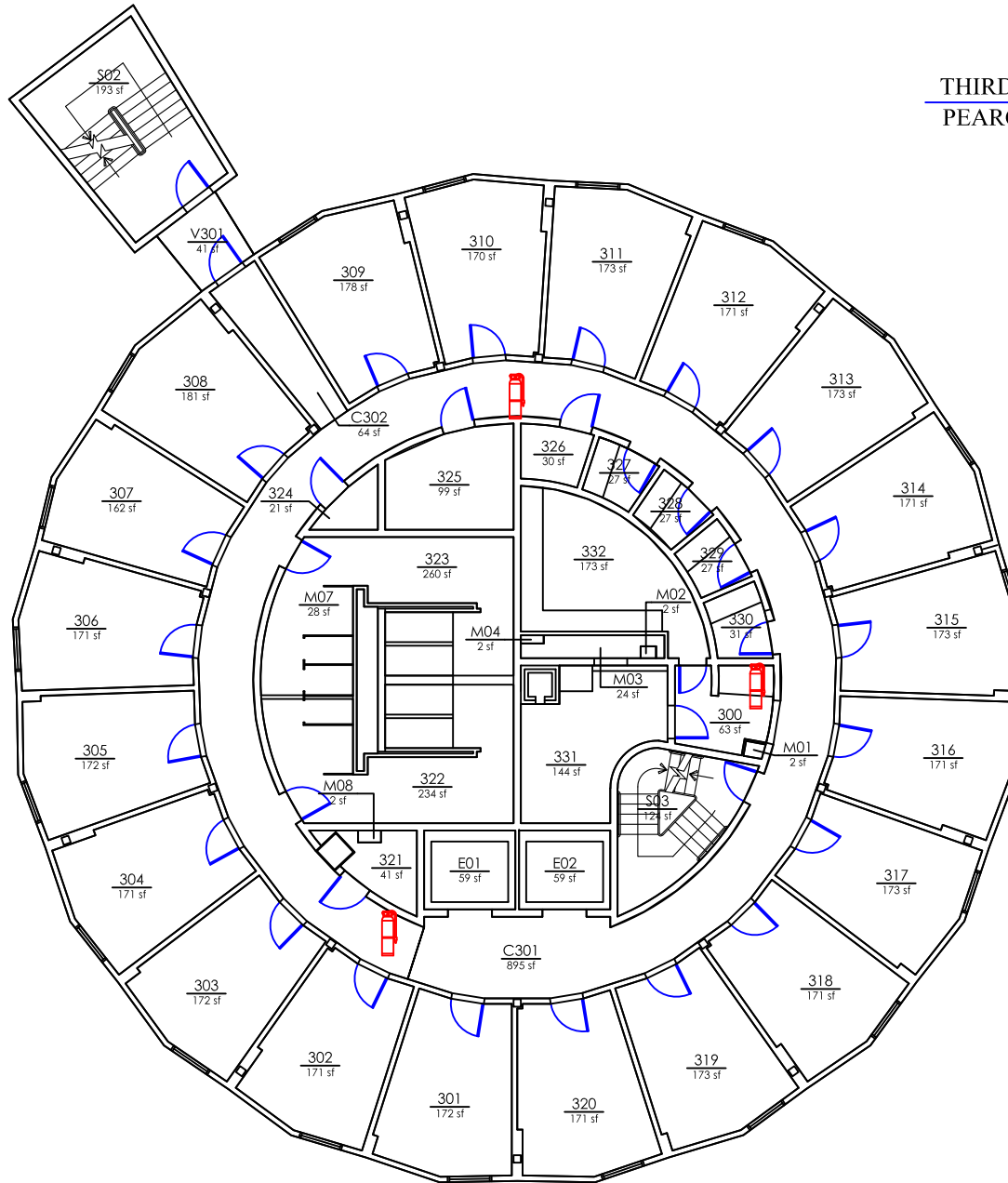
THIRD FLOOR
PEARCE HALL 



 FICM Code 210 Classroom
 FICM Code 110 Classroom



 = FIRE EXTINGUISHER  = AED  = FIRE DEP. CONNECTION  = LOCK BOX  = FIRE ALARM CONTROL PANEL  = SPRINKLER HEADER **R** = SPRINKLER RISER  = Bottle Filler

DATE REVISED	ADDRESS	Square Feet	BLDG NO	(PRC) PEARCE HALL THIRD FLOOR	FLOOR
10/23/2020	1112 Elm Street	6845	1170		3

DRAWINGS ARE NOT TO SCALE

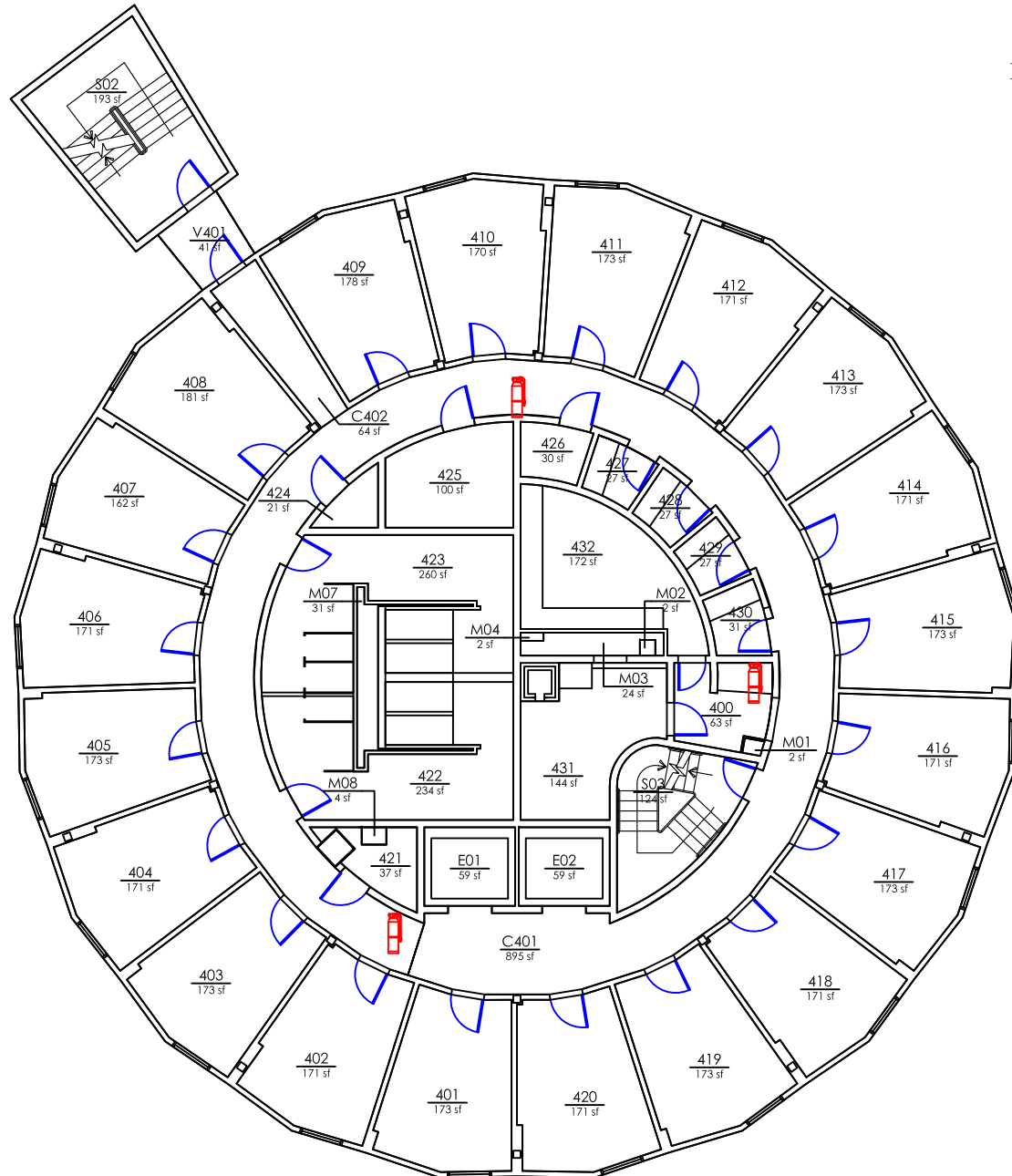
FOURTH FLOOR
PEARCE HALL





 FICM Code 210 Classroom
 FICM Code 110 Classroom

 = FIRE EXTINGUISHER  = AED  = FIRE DEP. CONNECTION  = LOCK BOX  = FIRE ALARM CONTROL PANEL  = SPRINKLER HEADER **R** = SPRINKLER RISER  = Bottle Filler

DATE REVISED	ADDRESS	Square Feet	BLDG NO	(PRC) PEARCE HALL FOURTH FLOOR	FLOOR
10/23/2020	1112 Elm Street	6845	1170		4

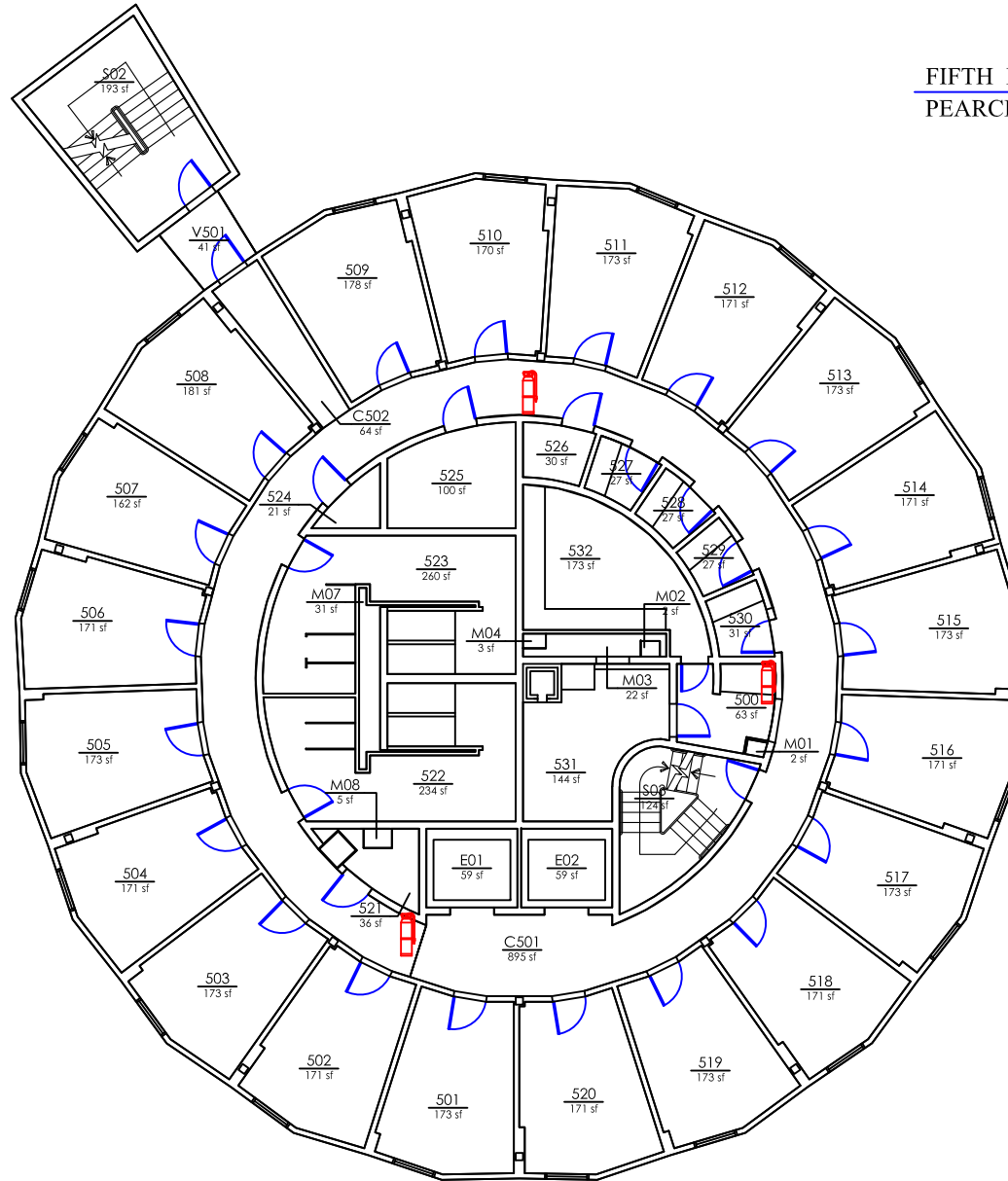
FIFTH FLOOR
PEARCE HALL



- FICM Code 210 Classroom
- FICM Code 110 Classroom

- = FIRE EXTINGUISHER
- = AED
- = FIRE DEP. CONNECTION
- = LOCK BOX
- = FIRE ALARM CONTROL PANEL
- = SPRINKLER HEADER
- = SPRINKLER RISER
- = Bottle Filler

DATE REVISED	ADDRESS	Square Feet	BLDG NO	(PRC) PEARCE HALL FIFTH FLOOR	FLOOR
10/31/2020	1112 Elm Street	6845	1170		5

DRAWINGS ARE NOT TO SCALE

SIXTH FLOOR
PEARCE HALL

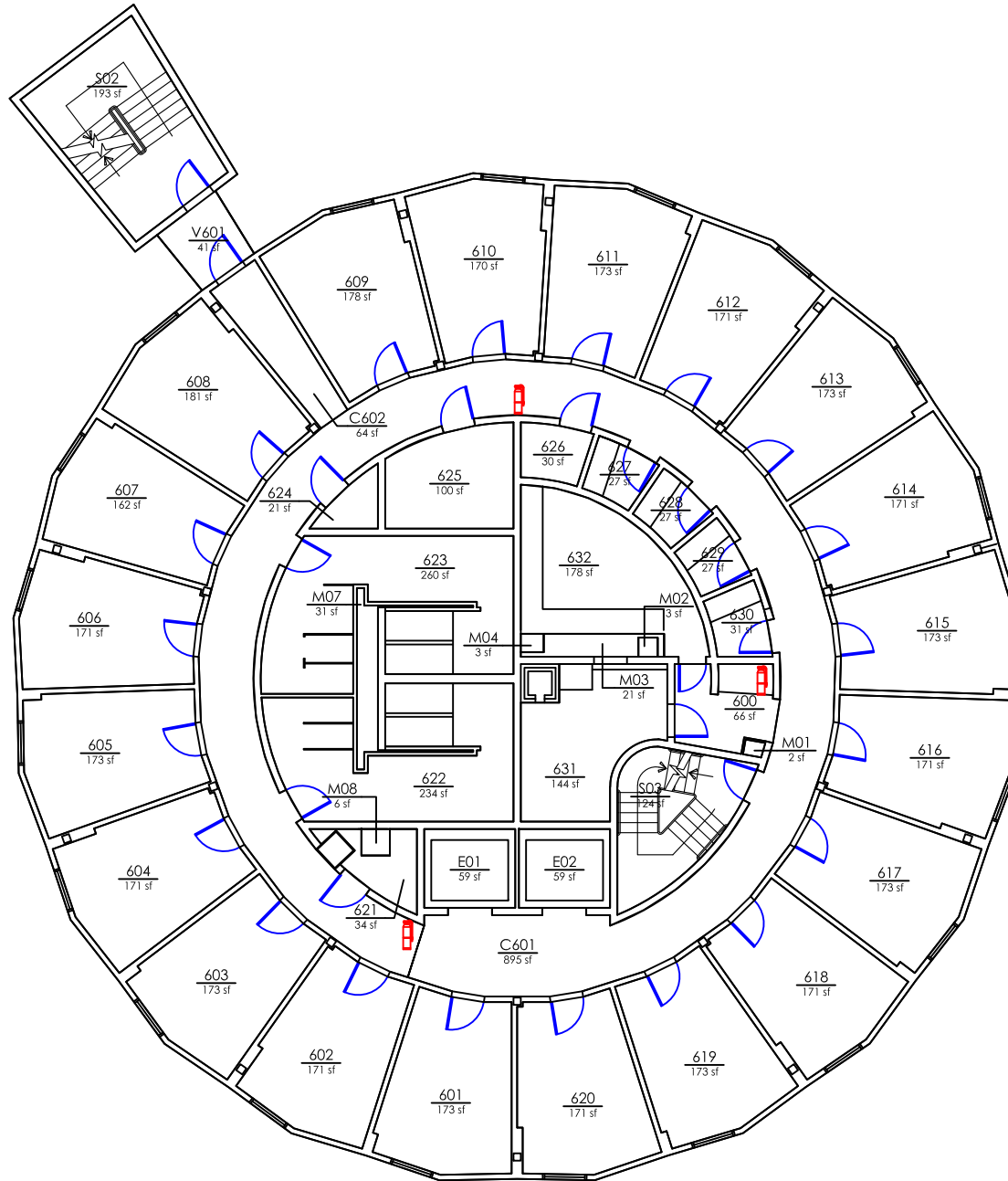

- FICM Code 210 Classroom
- FICM Code 110 Classroom

- = FIRE EXTINGUISHER
- = AED
- = FIRE DEP. CONNECTION
- = LOCK BOX
- = FIRE ALARM CONTROL PANEL
- = SPRINKLER HEADER
- R** = SPRINKLER RISER
- = Bottle Filler

DATE REVISED
10/31/2020

ADDRESS
1112 Elm
Street

Square Feet
6845

BLDG NO
1170



(PRC) PEARCE HALL
SIXTH FLOOR

FLOOR
6

DRAWINGS ARE NOT TO SCALE

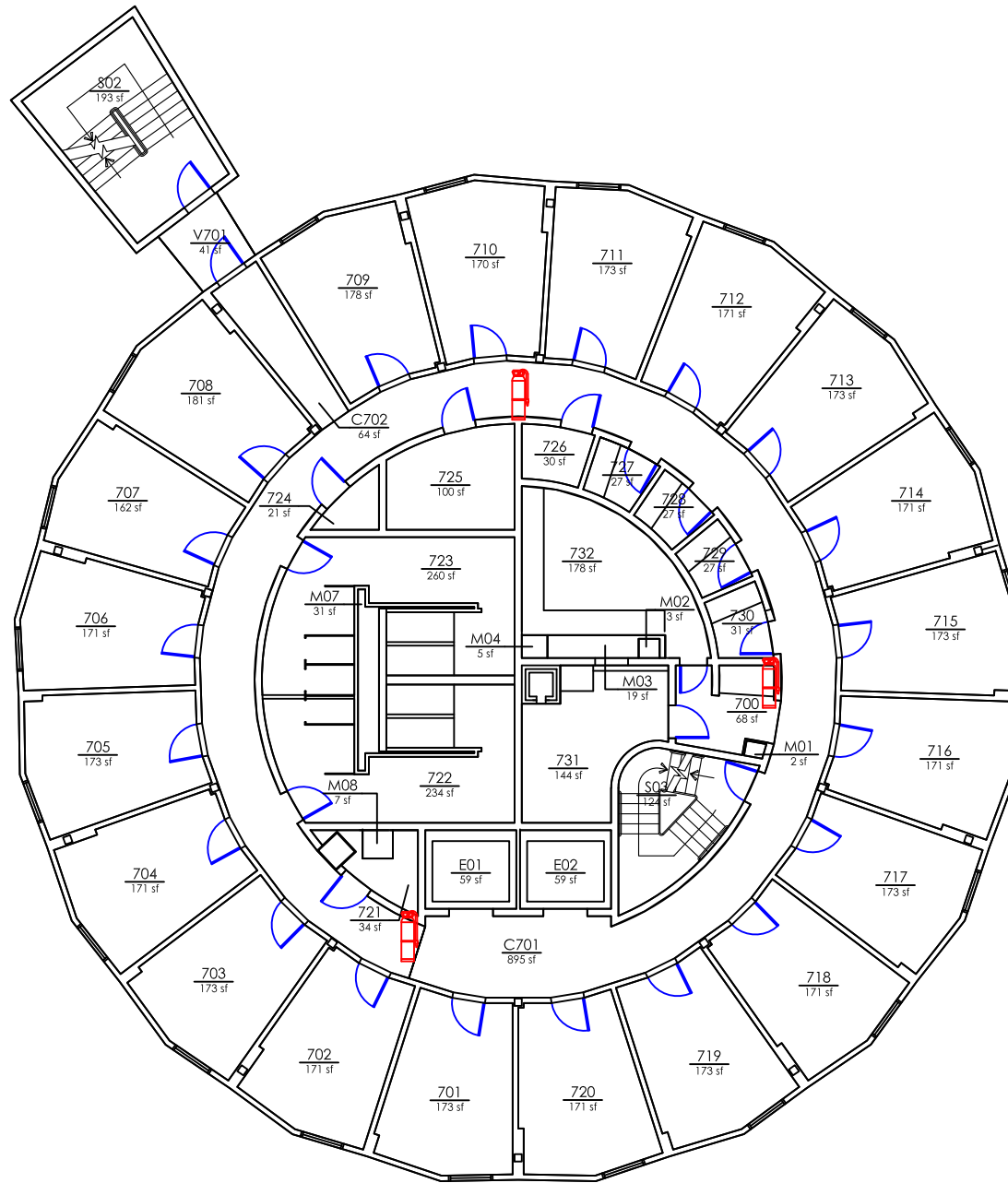
SEVENTH FLOOR
PEARCE HALL

-  FICM Code 210 Classroom
-  FICM Code 110 Classroom

-  = FIRE EXTINGUISHER
-  = AED
-  = FIRE DEP. CONNECTION
-  = LOCK BOX
-  = FIRE ALARM CONTROL PANEL
-  = SPRINKLER HEADER
-  = SPRINKLER RISER
-  = Bottle Filler

DATE REVISED
10/31/2020

ADDRESS
1112 Elm
Street

Square Feet
6845

BLDG NO
1170

(PRC) PEARCE HALL
SEVENTH FLOOR

FLOOR
7

DRAWINGS ARE NOT TO SCALE

EIGHTH FLOOR
PEARCE HALL

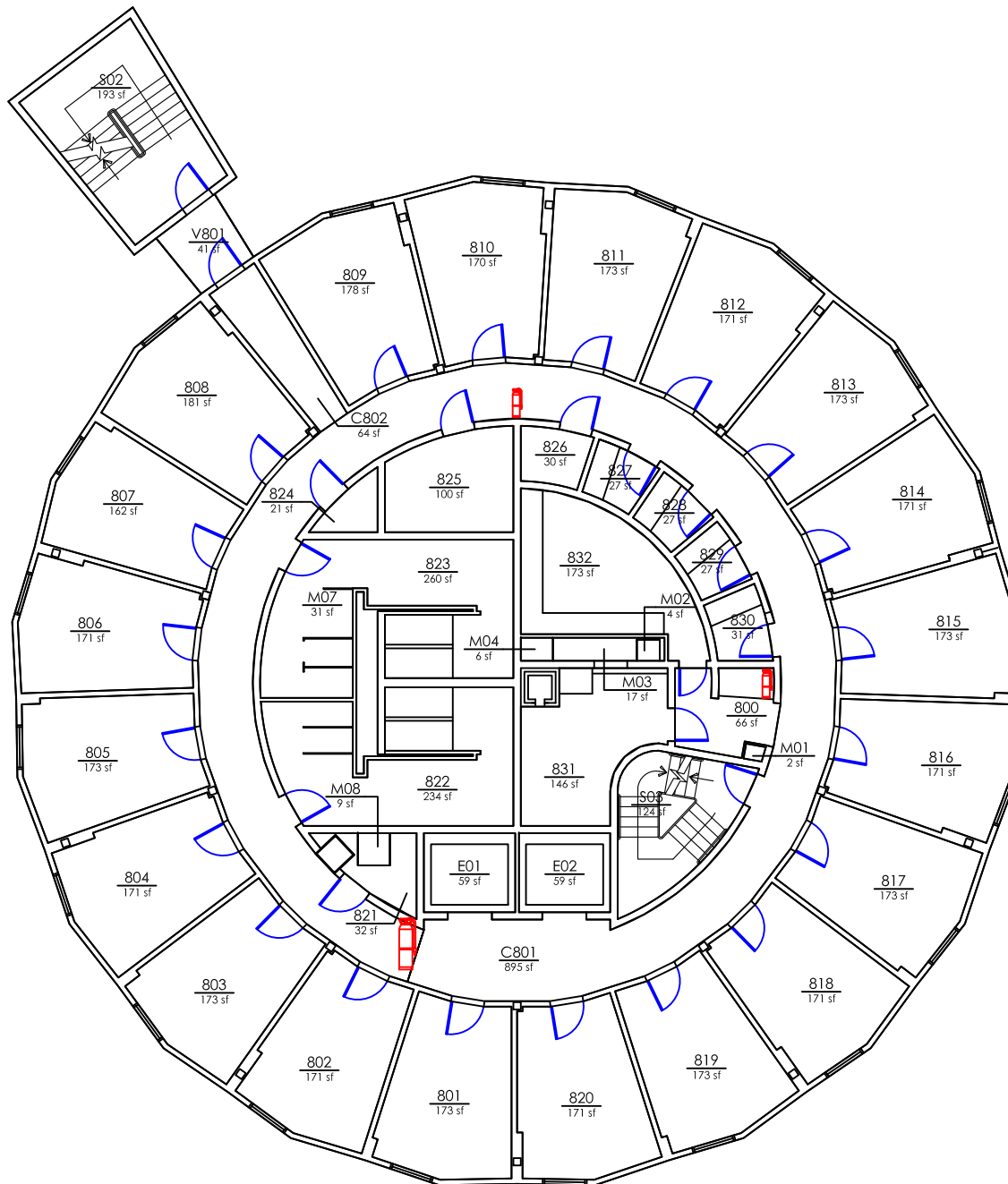



- FICM Code 210 Classroom
- FICM Code 110 Classroom

- = FIRE EXTINGUISHER
- = AED
- = FIRE DEP. CONNECTION
- = LOCK BOX
- = FIRE ALARM CONTROL PANEL
- = SPRINKLER HEADER
- = SPRINKLER RISER
- = Bottle Filler

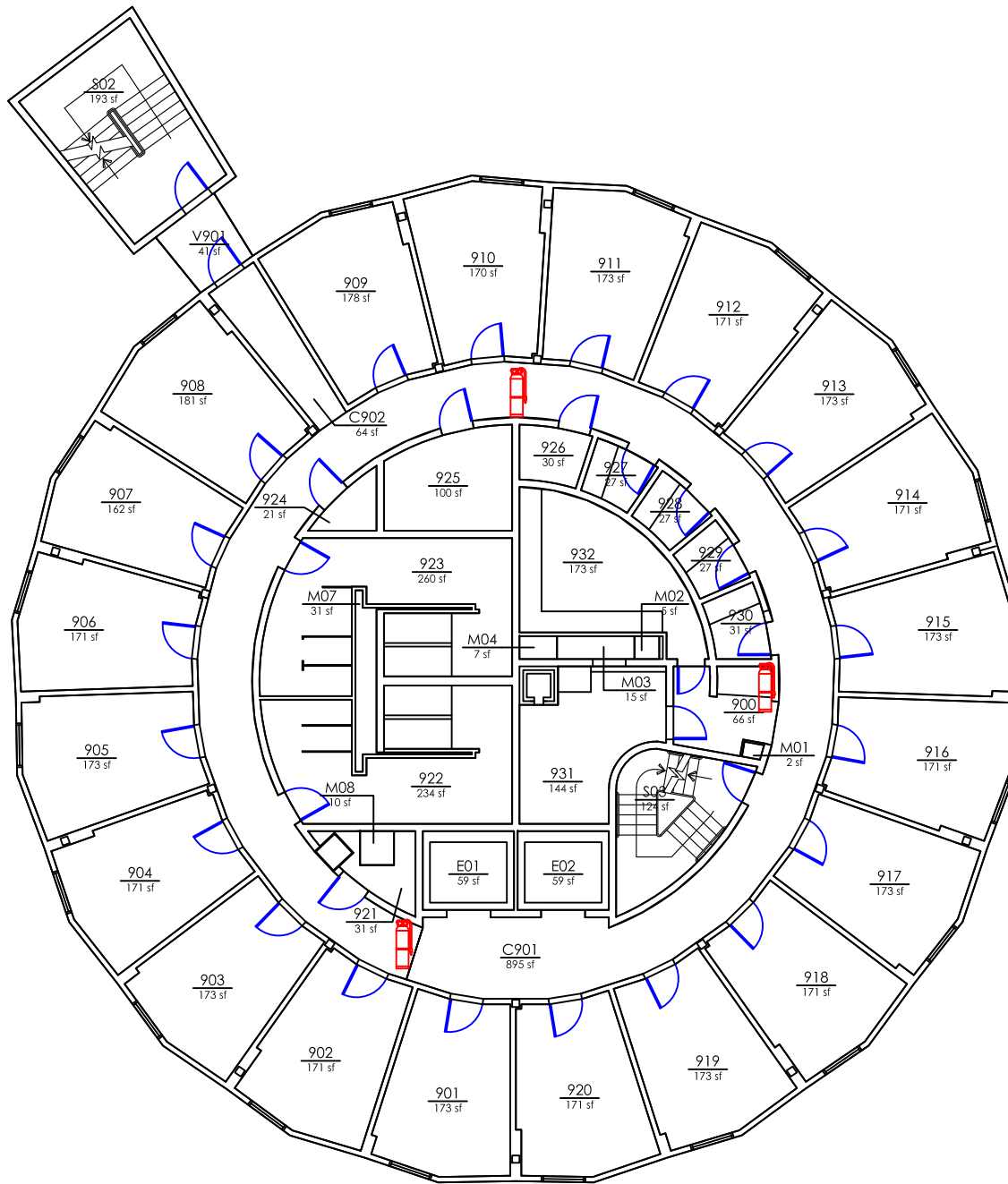
DATE REVISED 10/31/2020	ADDRESS 1112 Elm Street	Square Feet 6845	BLDG NO 1170	(PRC) PEARCE HALL EIGHTH FLOOR	FLOOR 8
-----------------------------------	-----------------------------------	----------------------------	------------------------	---	--------------------



-  FICM Code 210 Classroom
-  FICM Code 110 Classroom

-  = FIRE EXTINGUISHER
-  = AED
-  = FIRE DEP. CONNECTION
-  = LOCK BOX
-  = FIRE ALARM CONTROL PANEL
-  = SPRINKLER HEADER
-  = SPRINKLER RISER
-  = Bottle Filler

DATE REVISED
10/31/2020

ADDRESS
1112 Elm
Street



Square Feet
6845

BLDG NO
1170

(PRC) PEARCE HALL
NINTH FLOOR

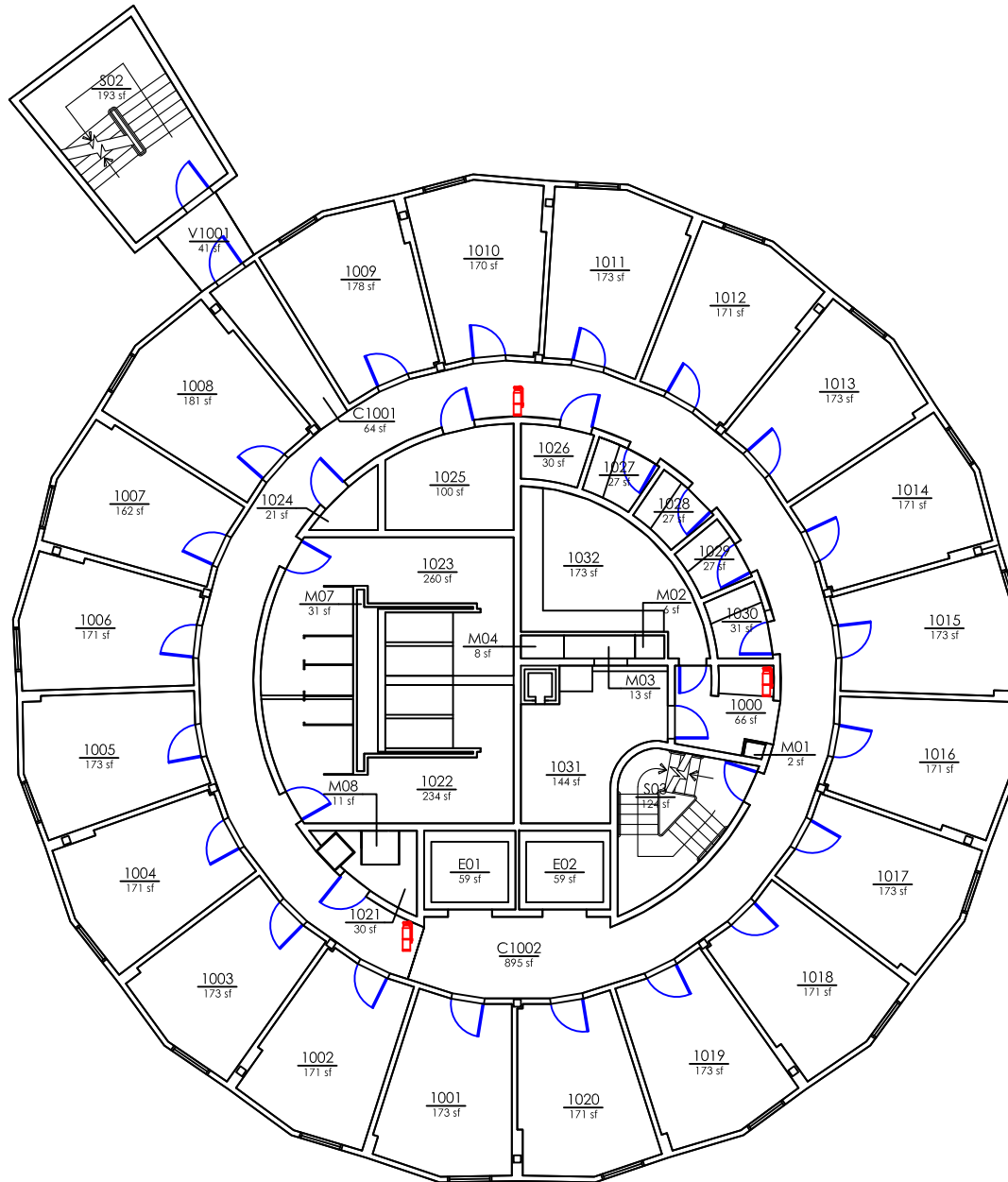
FLOOR
9



 FICM Code 210 Classroom
 FICM Code 110 Classroom

 = FIRE EXTINGUISHER  = AED  = FIRE DEP. CONNECTION  = LOCK BOX  = FIRE ALARM CONTROL PANEL  = SPRINKLER HEADER **R** = SPRINKLER RISER  = Bottle Filler

DATE REVISED
11/1/2020

ADDRESS
1112 Elm
Street



Square Feet
6845

BLDG NO
1170

(PRC) PEARCE HALL
TENTH FLOOR

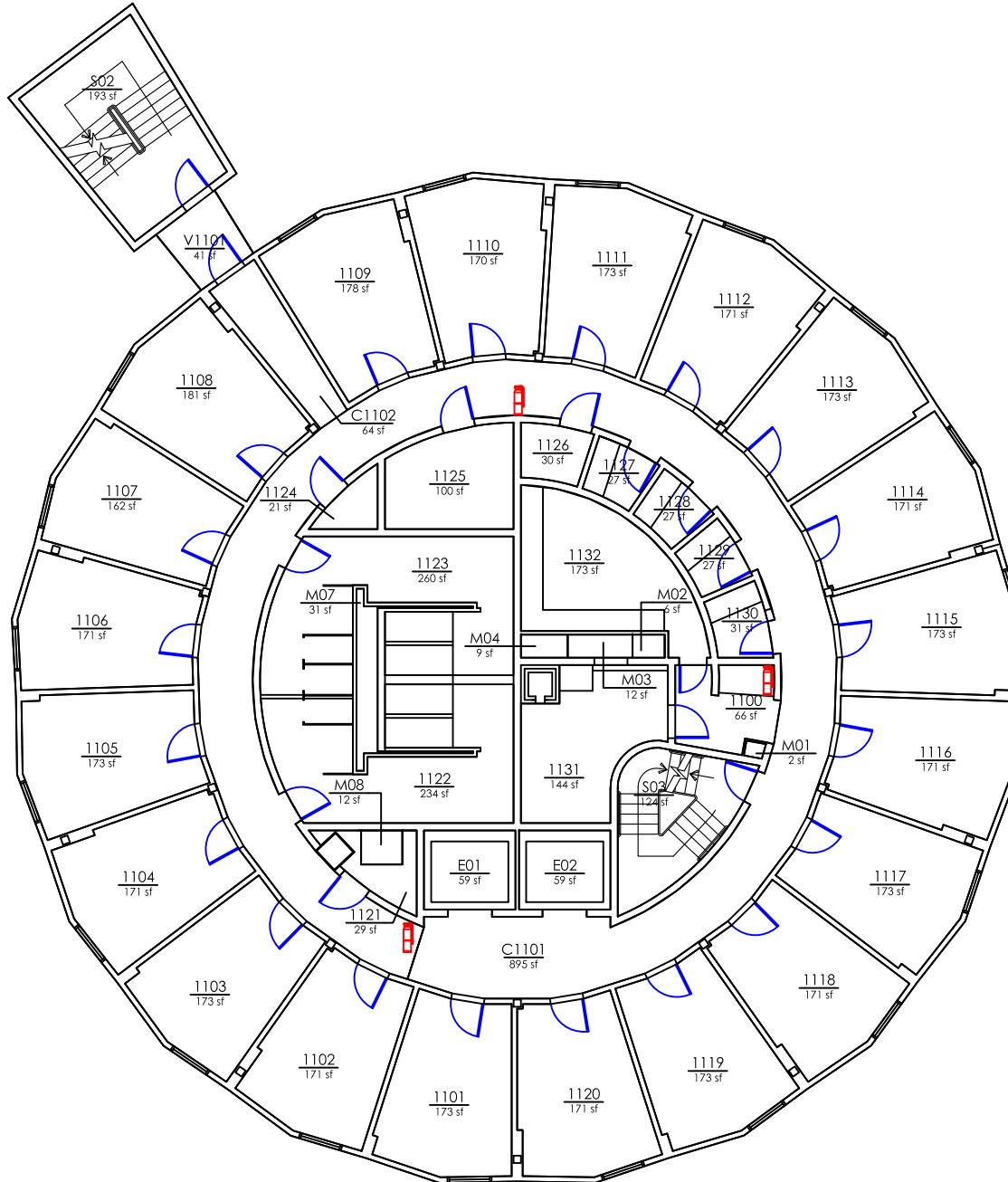
FLOOR
10



 FICM Code 210 Classroom
 FICM Code 110 Classroom

 = FIRE EXTINGUISHER  = AED  = FIRE DEP. CONNECTION  = LOCK BOX  = FIRE ALARM CONTROL PANEL  = SPRINKLER HEADER **R** = SPRINKLER RISER  = Bottle Filler

DATE REVISED
11/1/2020

ADDRESS
1112 Elm Street

Square Feet
6845

BLDG NO
1170

(PRC) PEARCE HALL
ELEVENTH FLOOR

FLOOR
11

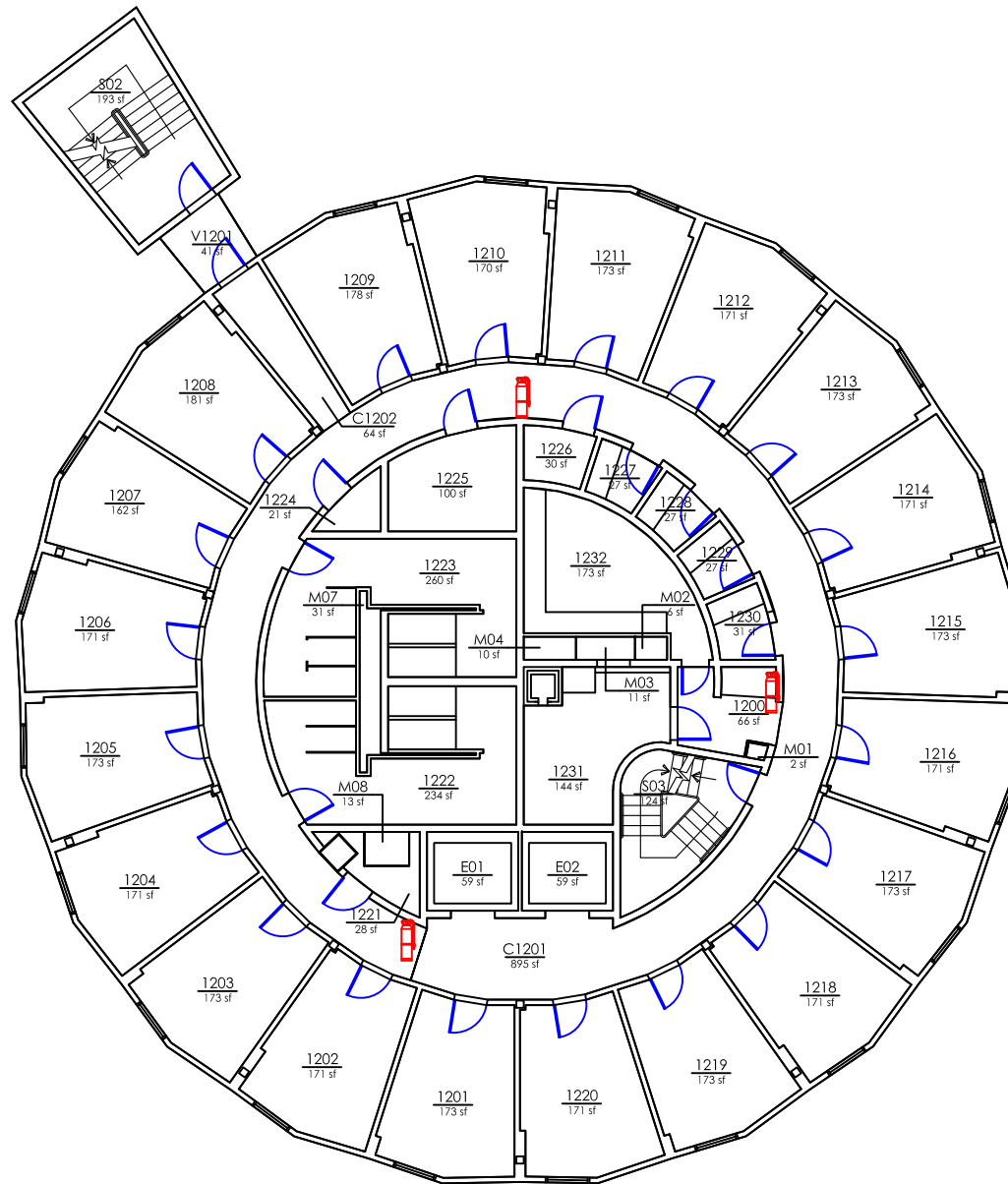

- FICM Code 210 Classroom
- FICM Code 110 Classroom

- = FIRE EXTINGUISHER
- = AED
- = FIRE DEP. CONNECTION
- = LOCK BOX
- = FIRE ALARM CONTROL PANEL
- = SPRINKLER HEADER
- = SPRINKLER RISER
- = Bottle Filler

DATE REVISED
11/1/2020

ADDRESS
1112 Elm
Street

Square Feet
6845

BLDG NO
1170



(PRC) PEARCE HALL
TWELFTH FLOOR

FLOOR
12

DRAWINGS ARE NOT TO SCALE

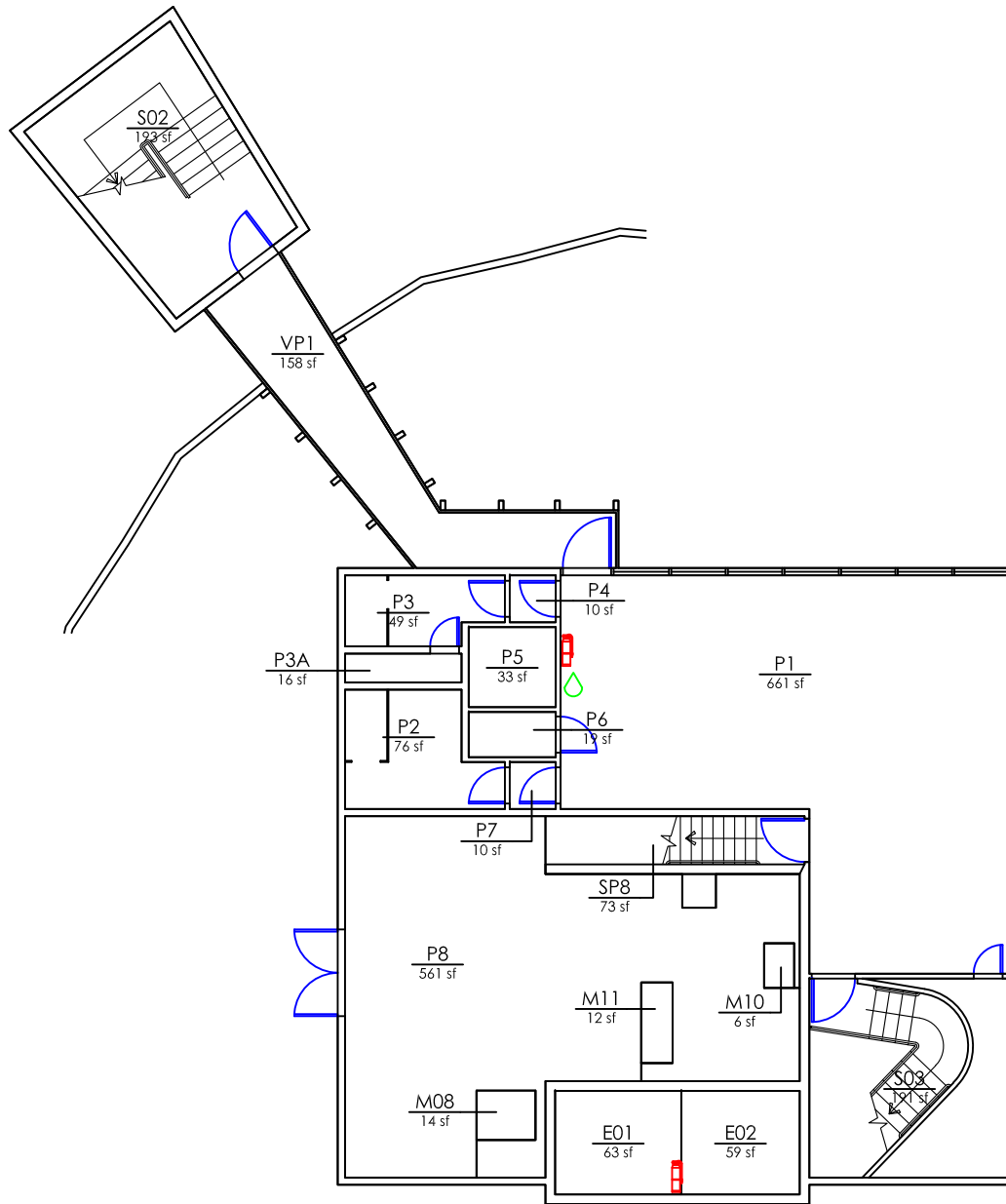
PENTHOUSE FLOOR PLAN
PEARCE HALL







 FICM Code 210 Classroom
 FICM Code 110 Classroom

 = FIRE EXTINGUISHER  = AED  = FIRE DEP. CONNECTION  = LOCK BOX  = FIRE ALARM CONTROL PANEL  = SPRINKLER HEADER **R** = SPRINKLER RISER  = Bottle Filler

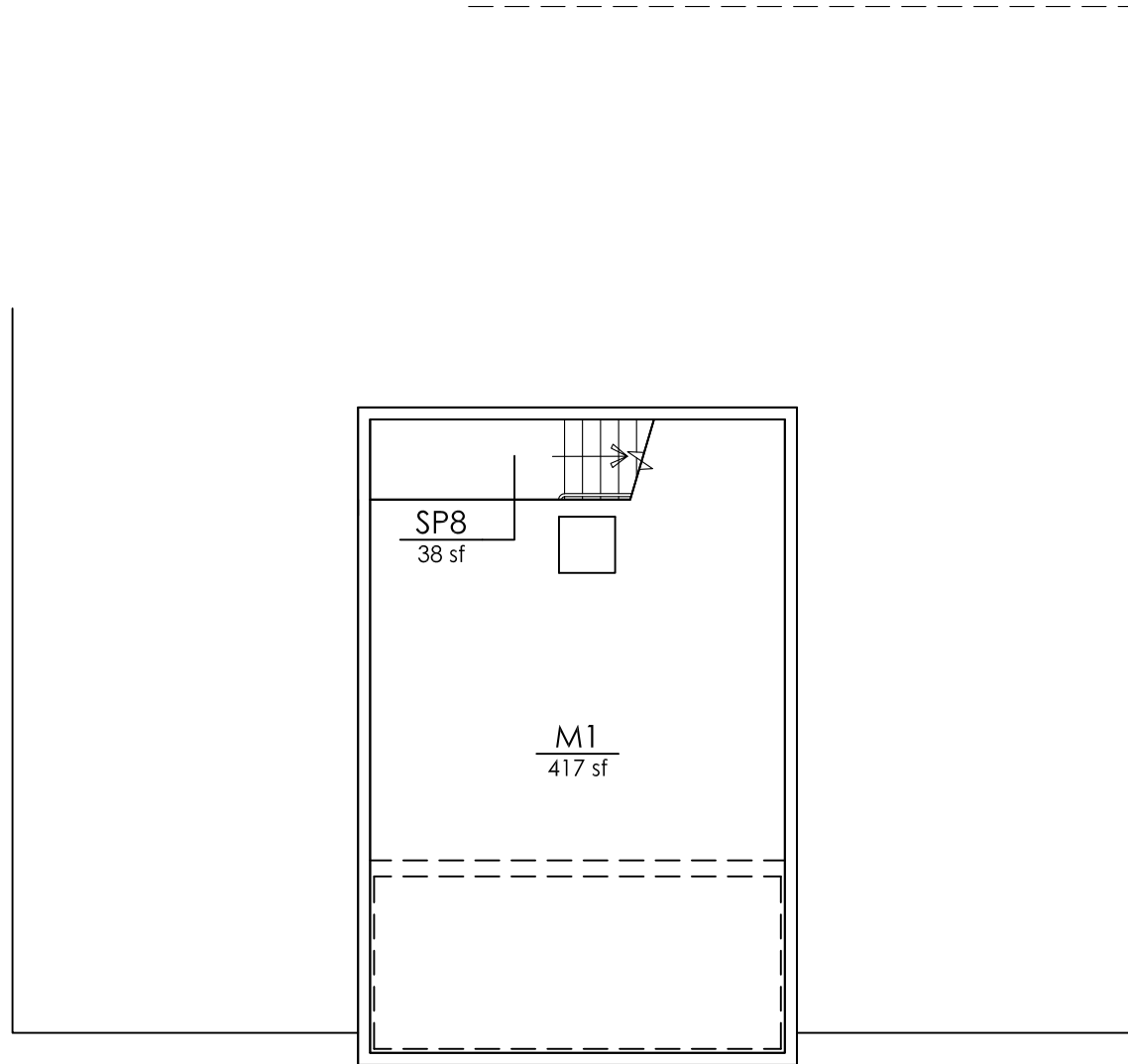
DATE REVISED 11/1/2020	ADDRESS 1112 Elm Street	Square Feet 2433	BLDG NO 1170	(PRC) PEARCE HALL PENTHOUSE FLOOR	FLOOR 13
---------------------------	----------------------------	---------------------	-----------------	--------------------------------------	-------------

MACHINE ROOM PEARCE HALL





-  FICM Code 210 Classroom
-  FICM Code 110 Classroom

-  = FIRE EXTINGUISHER
-  = AED
-  = FIRE DEP. CONNECTION
-  = LOCK BOX
-  = FIRE ALARM CONTROL PANEL
-  = SPRINKLER HEADER
-  = SPRINKLER RISER
-  = Bottle Filler

DATE REVISED	ADDRESS	Square Feet	BLDG NO	(PRC) PEARCE HALL MACHINE ROOM	FLOOR
11/1/2020	1112 Elm Street	499	1170		14

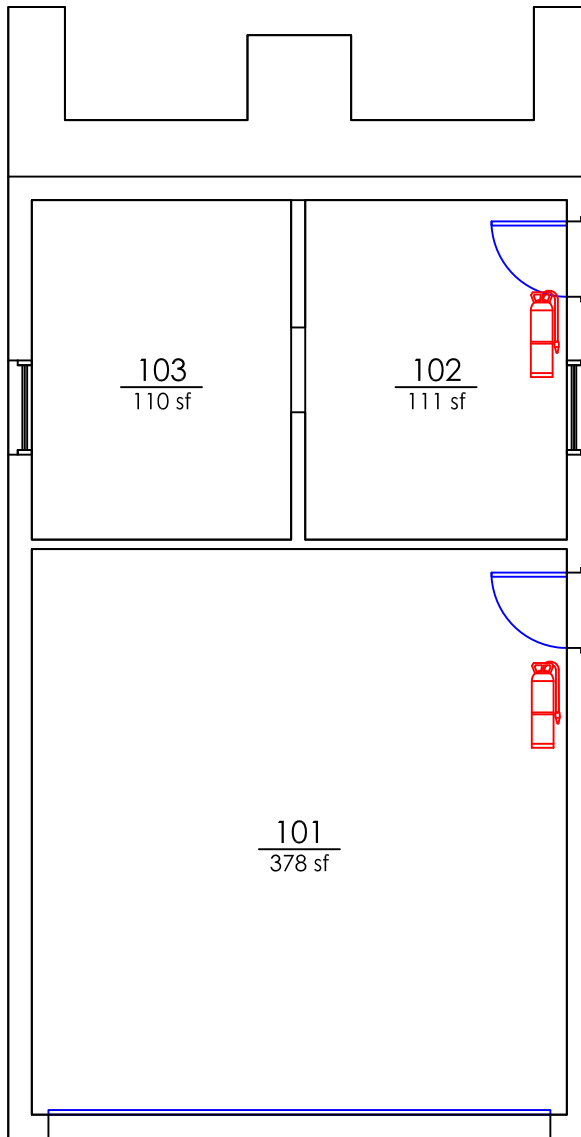
DRAWINGS ARE NOT TO SCALE



 FICM Code 210 Classroom
 FICM Code 110 Classroom

 = FIRE EXTINGUISHER  = AED  = FIRE DEP. CONNECTION  = LOCK BOX  = FIRE ALARM CONTROL PANEL  = SPRINKLER HEADER **R** = SPRINKLER RISER  = Bottle Filler

DATE REVISED
11/1/2020

ADDRESS
629 D Street

Square Feet
768

BLDG NO
1185

(PRG) PRESIDENT'S GARAGE
FLOOR PLAN

FLOOR
1

BASEMENT LEVEL PLAN
UNIVERSITY HOUSE



- FICM Code 210 Classroom
- FICM Code 110 Classroom

- = FIRE EXTINGUISHER
- = AED
- = FIRE DEP. CONNECTION
- = LOCK BOX
- = FIRE ALARM CONTROL PANEL
- = SPRINKLER HEADER
- = SPRINKLER RISER
- = Bottle Filler

DATE REVISED 11/1/2020	ADDRESS 615 Study LN	Square Feet 1514	BLDG NO 1184	(PRH) UNIVERSITY HOUSE BASEMENT	FLOOR 0
---------------------------	-------------------------	---------------------	-----------------	------------------------------------	------------

MAIN LEVEL PLAN UNIVERSITY HOUSE

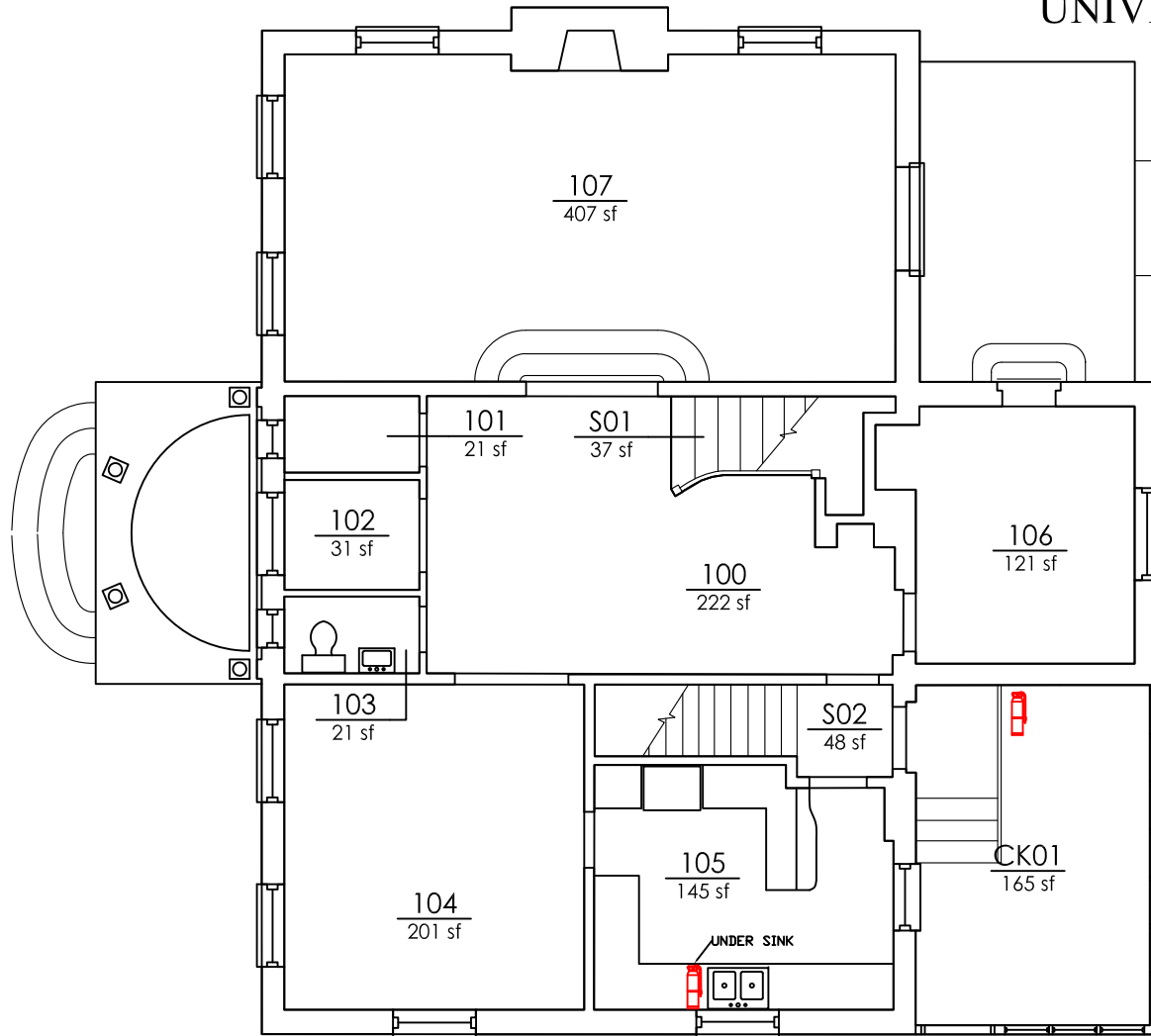

FICM Code 210 Classroom
 FICM Code 110 Classroom

= FIRE EXTINGUISHER = AED = FIRE DEP. CONNECTION = LOCK BOX = FIRE ALARM CONTROL PANEL = SPRINKLER HEADER = SPRINKLER RISER = Bottle Filler

DATE REVISED 11/8/2020	ADDRESS 615 Study LN	Square Feet 1695	BLDG NO 1184	(PRH) UNIVERSITY HOUSE FIRST FLOOR	FLOOR 1
---------------------------	-------------------------	---------------------	-----------------	---------------------------------------	------------

SECOND FLOOR UNIVERSITY HOUSE

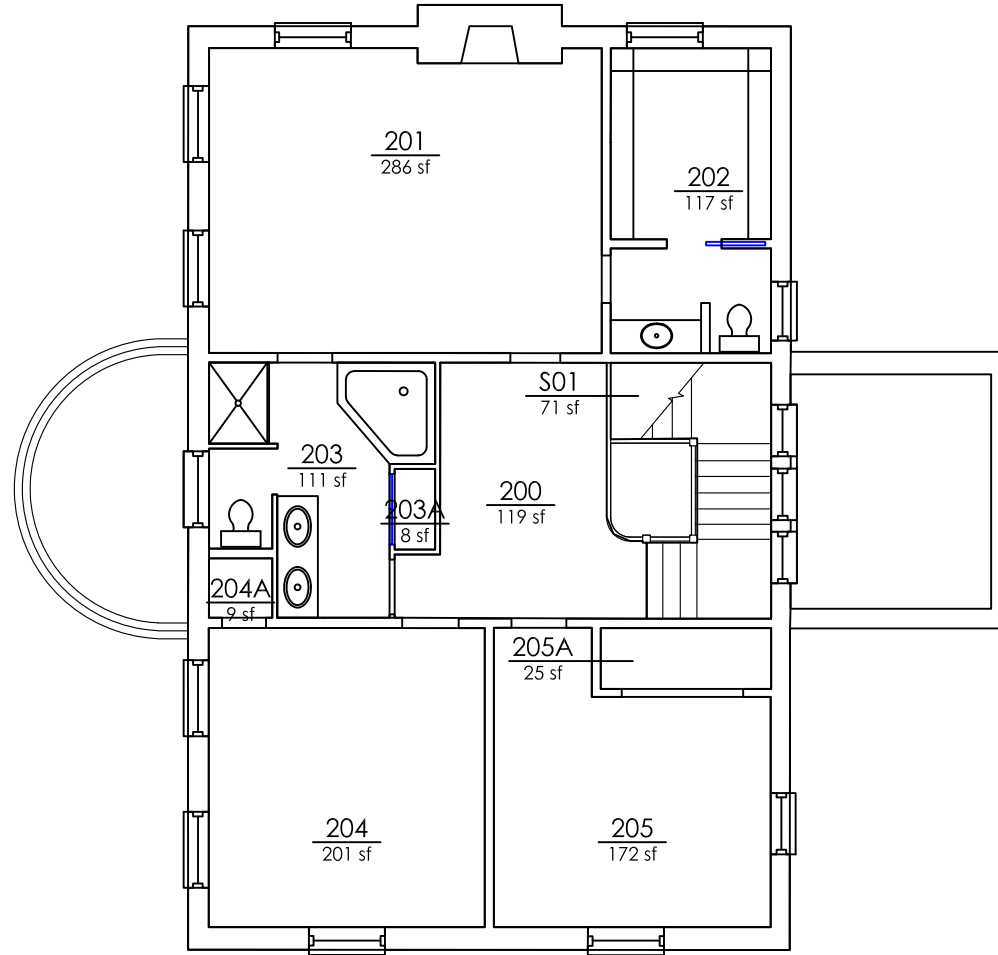



- FICM Code 210 Classroom
- FICM Code 110 Classroom

- = FIRE EXTINGUISHER
- = AED
- = FIRE DEP. CONNECTION
- = LOCK BOX
- = FIRE ALARM CONTROL PANEL
- = SPRINKLER HEADER
- = SPRINKLER RISER
- = Bottle Filler

DATE REVISED 11/8/2020	ADDRESS 615 Study LN	Square Feet 1349	BLDG NO 1184	(PRH) UNIVERSITY HOUSE SECOND FLOOR	FLOOR 2
---------------------------	-------------------------	---------------------	-----------------	--	------------

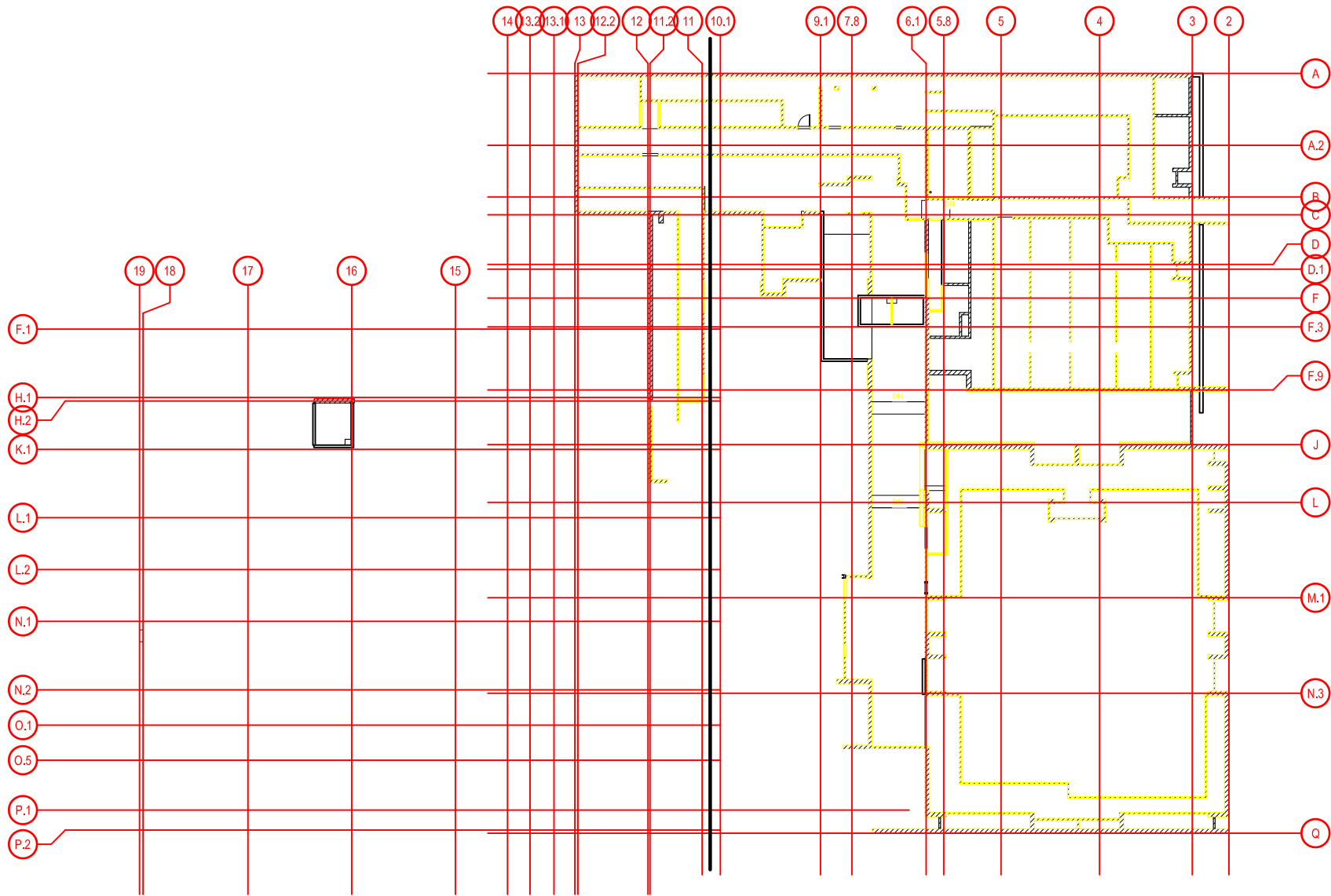
DRAWINGS ARE NOT TO SCALE



-  FICM Code 210 Classroom
-  FICM Code 110 Classroom

-  = FIRE EXTINGUISHER
-  = AED
-  = FIRE DEP. CONNECTION
-  = LOCK BOX
-  = FIRE ALARM CONTROL PANEL
-  = SPRINKLER HEADER
- R** = SPRINKLER RISER
-  = Bottle Filler

DATE REVISED
11/14/2020

ADDRESS
926 Elm St

Square Feet



BLDG NO
7007

(PUB) PENCE UNION
BUILDING BASEMENT

FLOOR
0

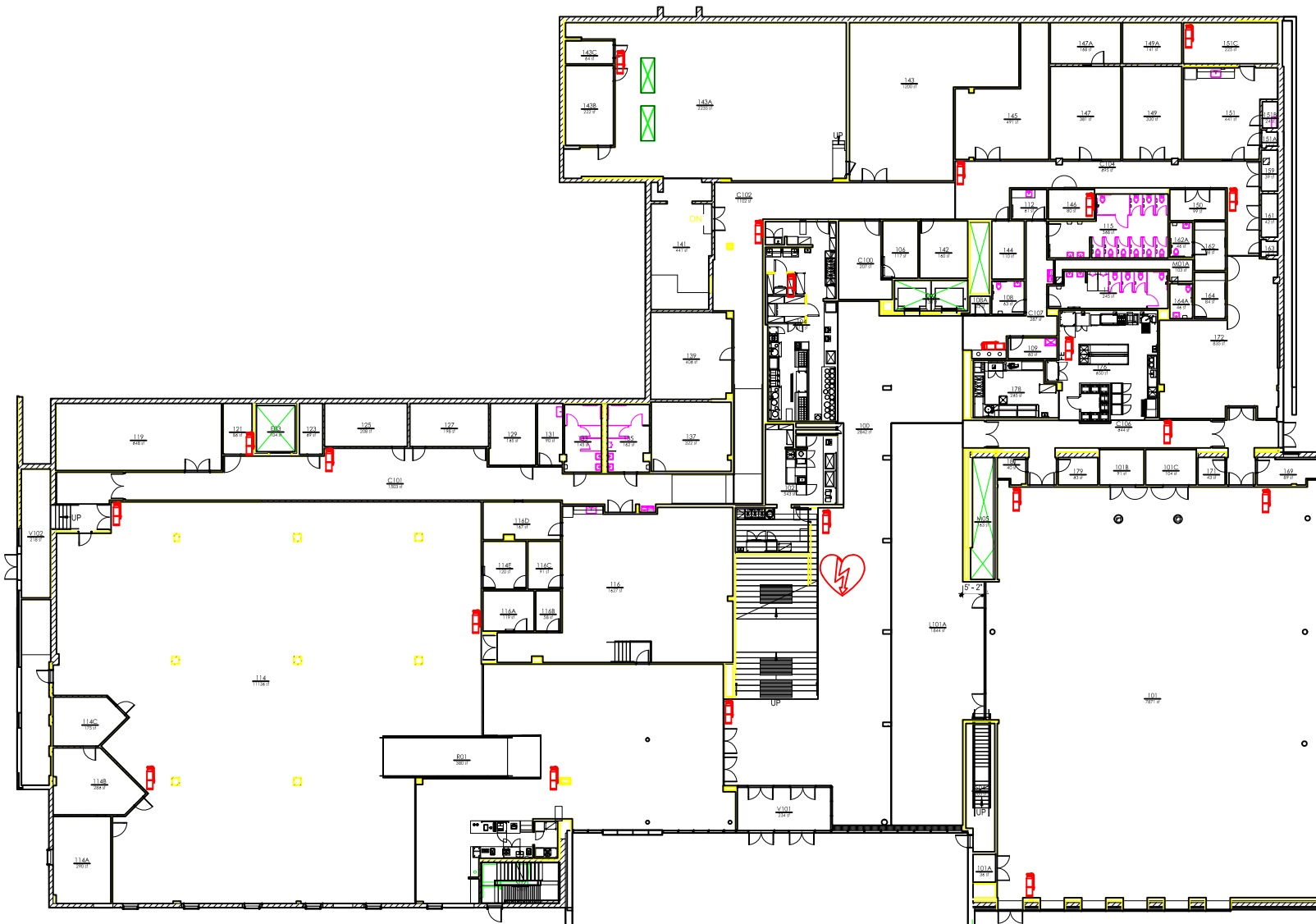
DRAWINGS ARE NOT TO SCALE



-  FICM Code 210 Classroom
-  FICM Code 110 Classroom

-  = FIRE EXTINGUISHER
-  = AED
-  = FIRE DEP. CONNECTION
-  = LOCK BOX
-  = FIRE ALARM CONTROL PANEL
-  = SPRINKLER HEADER
-  = SPRINKLER RISER
-  = Bottle Filler

DATE REVISED
11/14/2020

ADDRESS
926 Elm St

Square Feet
52393



BLDG NO
7007

(PUB) PENCE UNION
BUILDING FIRST FLOOR

FLOOR
1

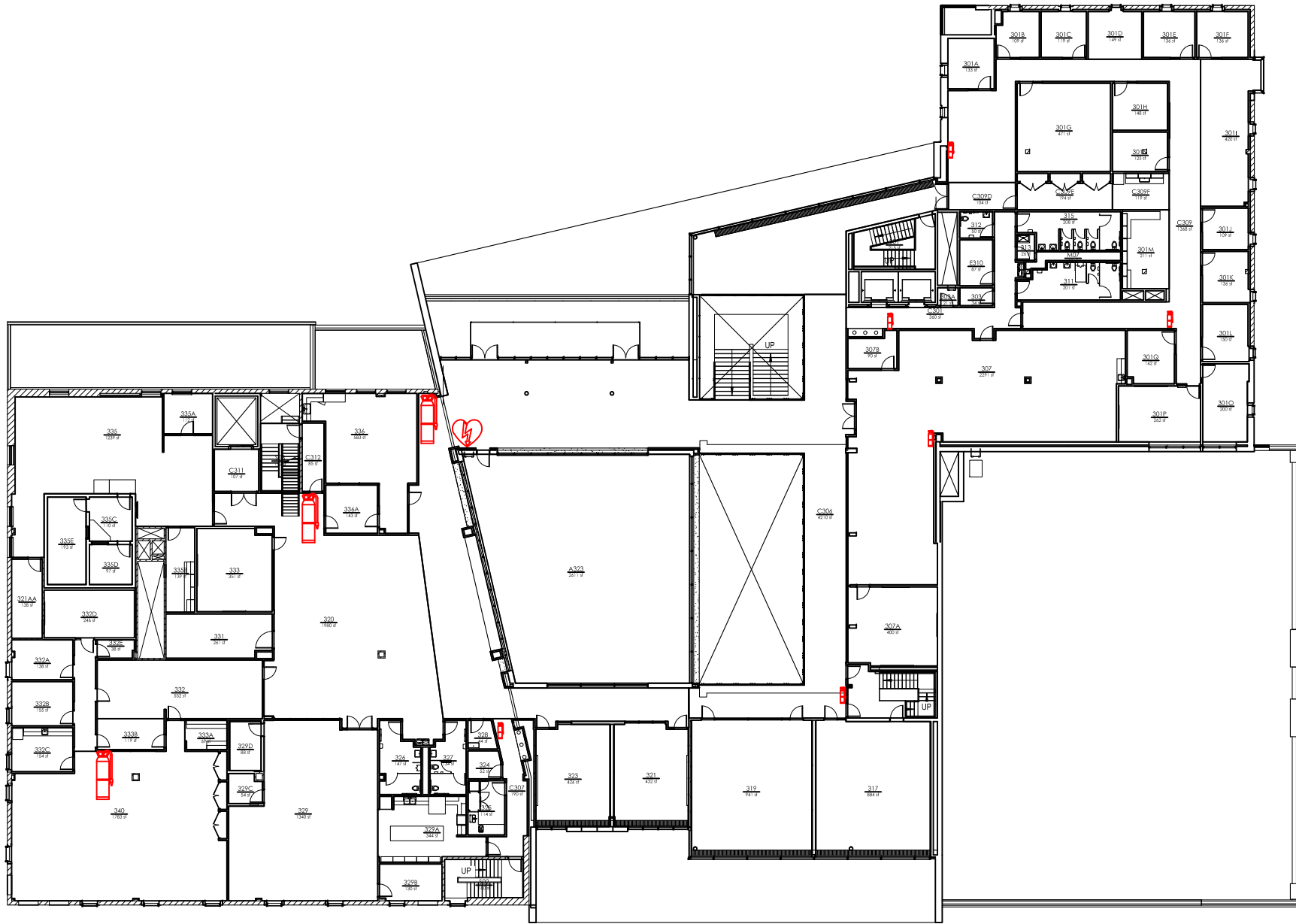
DRAWINGS ARE NOT TO SCALE



 FICM Code 210 Classroom
 FICM Code 110 Classroom

 = FIRE EXTINGUISHER
  = AED
  = FIRE DEP. CONNECTION
  = LOCK BOX
  = FIRE ALARM CONTROL PANEL
  = SPRINKLER HEADER
 R = SPRINKLER RISER
  = Bottle Filler

DATE REVISED
11/14/2020

ADDRESS
926 Elm St

Square Feet
27568

BLDG NO
7007

(PUB) PENCE UNION
BUILDING THIRD FLOOR

FLOOR
3

DRAWINGS ARE NOT TO SCALE

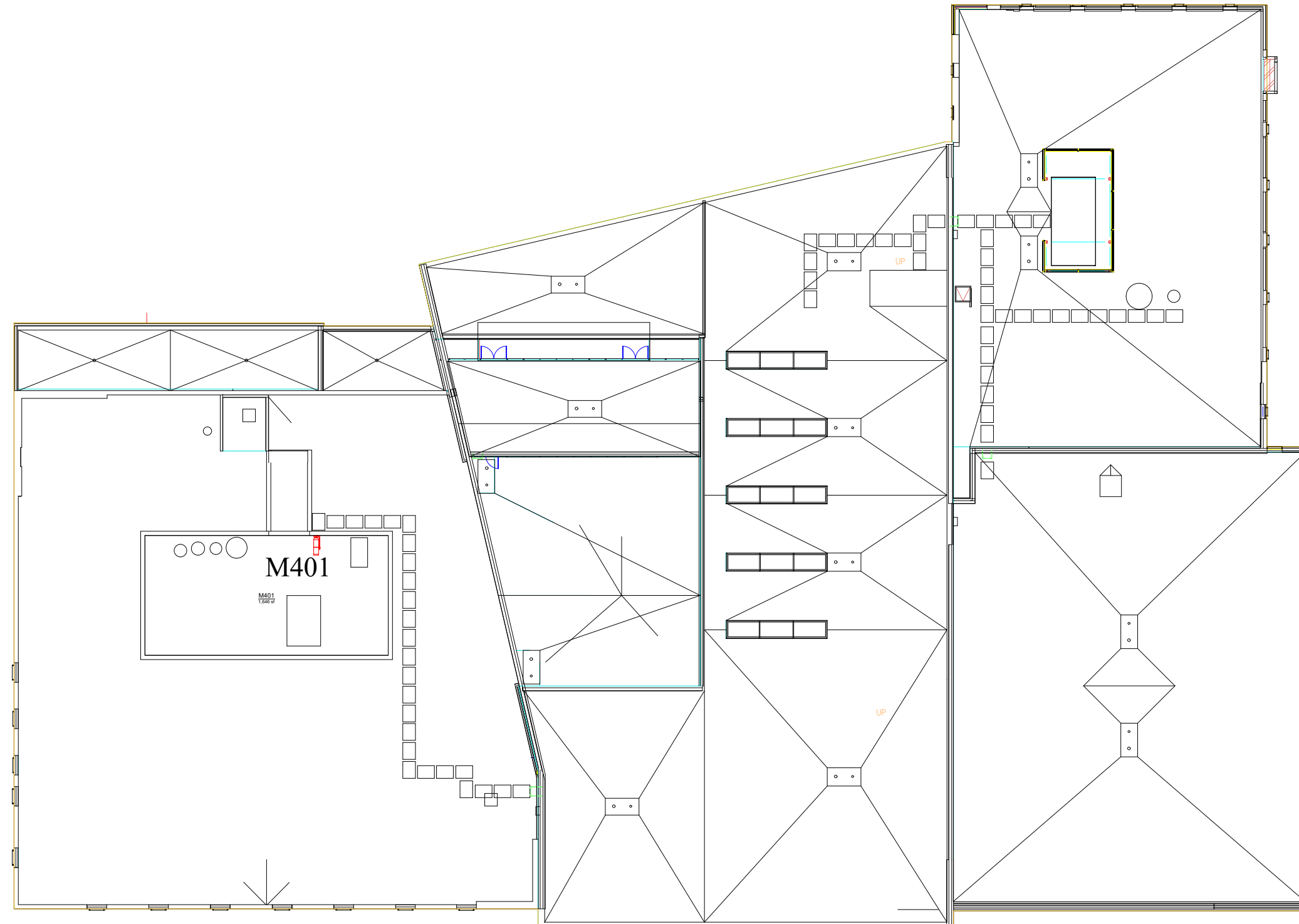

 = FIRE EXTINGUISHER
  = AED
  = FIRE DEP. CONNECTION
  = LOCK BOX
  = FIRE ALARM CONTROL PANEL
  = SPRINKLER HEADER
  = SPRINKLER RISER

DATE REVISED
02-01-22

ADDRESS
926 Elm Street

Square Feet
52300

AiM ID
7007

(PUB) PENCE UNION BUILDING
ROOF

FLOOR
4

DRAWINGS ARE NOT TO SCALE

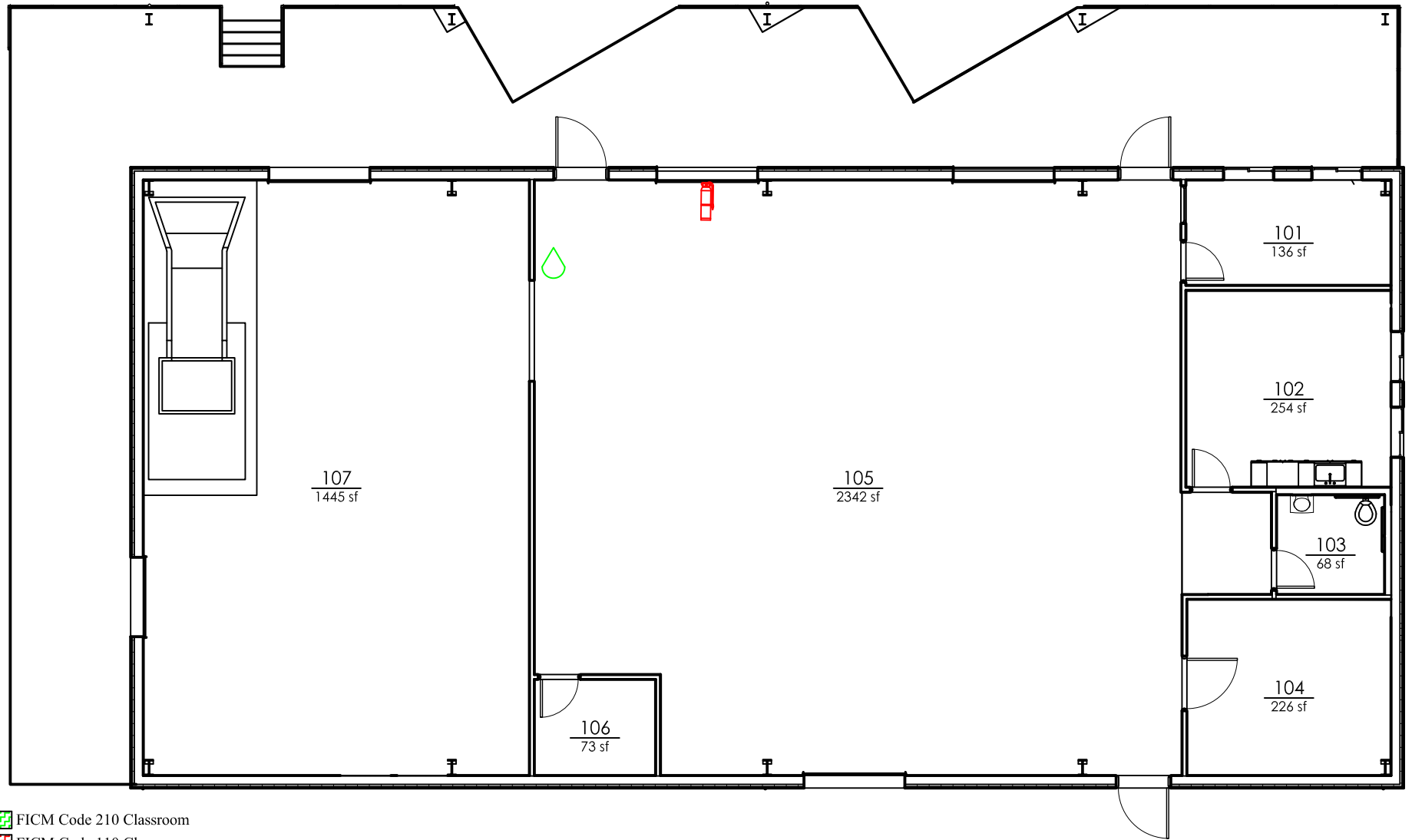



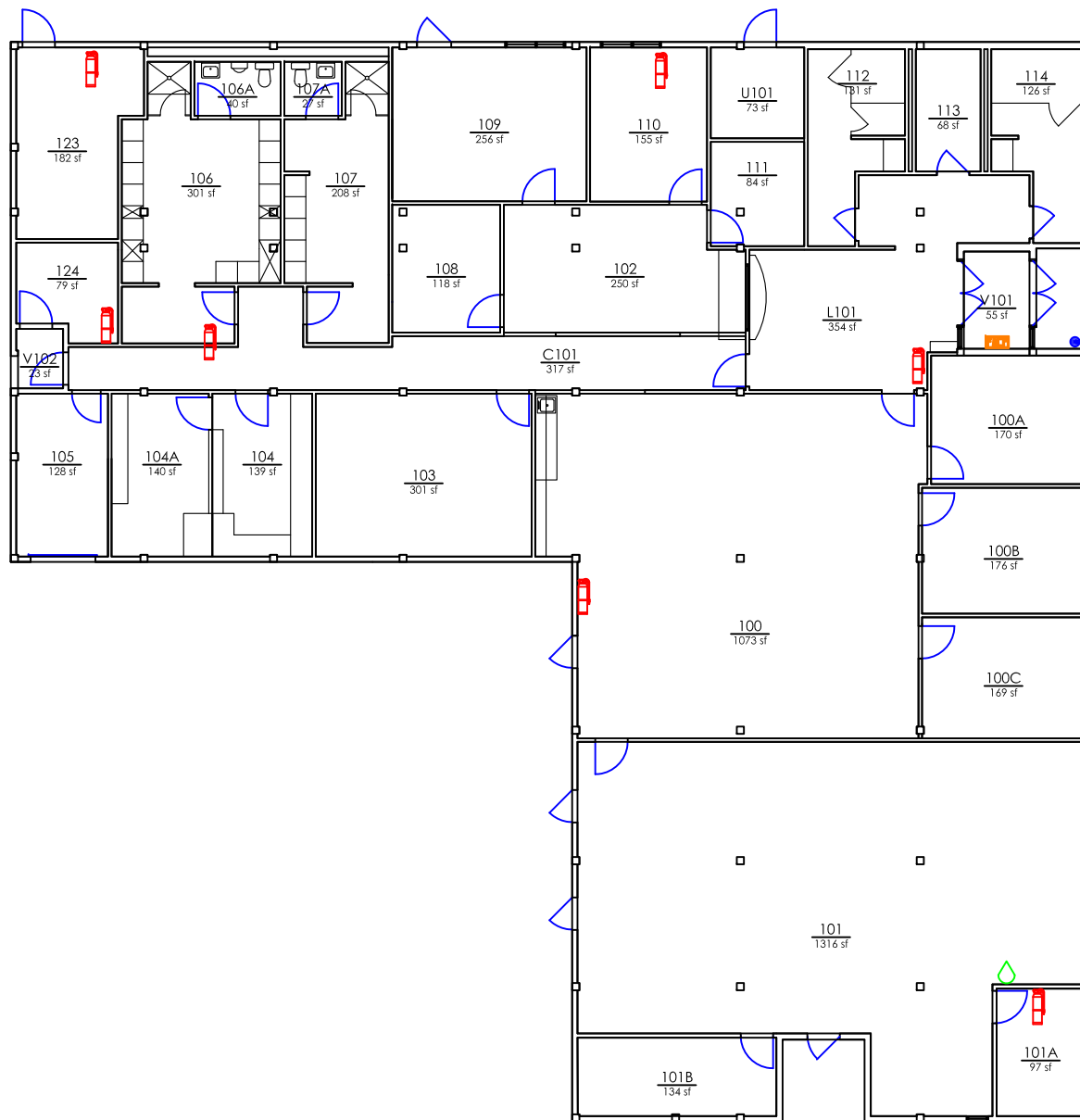

- FICM Code 210 Classroom
- FICM Code 110 Classroom

- = FIRE EXTINGUISHER
- = AED
- = FIRE DEP. CONNECTION
- = LOCK BOX
- = FIRE ALARM CONTROL PANEL
- = SPRINKLER HEADER
- = SPRINKLER RISER
- = Bottle Filler

DATE REVISED 11/16/2020	ADDRESS 1395 Tailgate LN	Square Feet 4966	BLDG NO 1406	(RCC) RECYCLE CENTER FIRST FLOOR	FLOOR 1
----------------------------	--------------------------------	---------------------	-----------------	---	------------



IN CRUISER 1

IN CRUISER 2

 FICM Code 210 Classroom
 FICM Code 110 Classroom

 = FIRE EXTINGUISHER  = AED  = FIRE DEP. CONNECTION  = LOCK BOX  = FIRE ALARM CONTROL PANEL  = SPRINKLER HEADER **R** = SPRINKLER RISER  = Bottle Filler

DATE REVISED
11/16/2020

ADDRESS
609 W 7th St

Square Feet
7201

BLDG NO
1205



(RDB)RED BARN
FIRST FLOOR

FLOOR
1

DRAWINGS ARE NOT TO SCALE

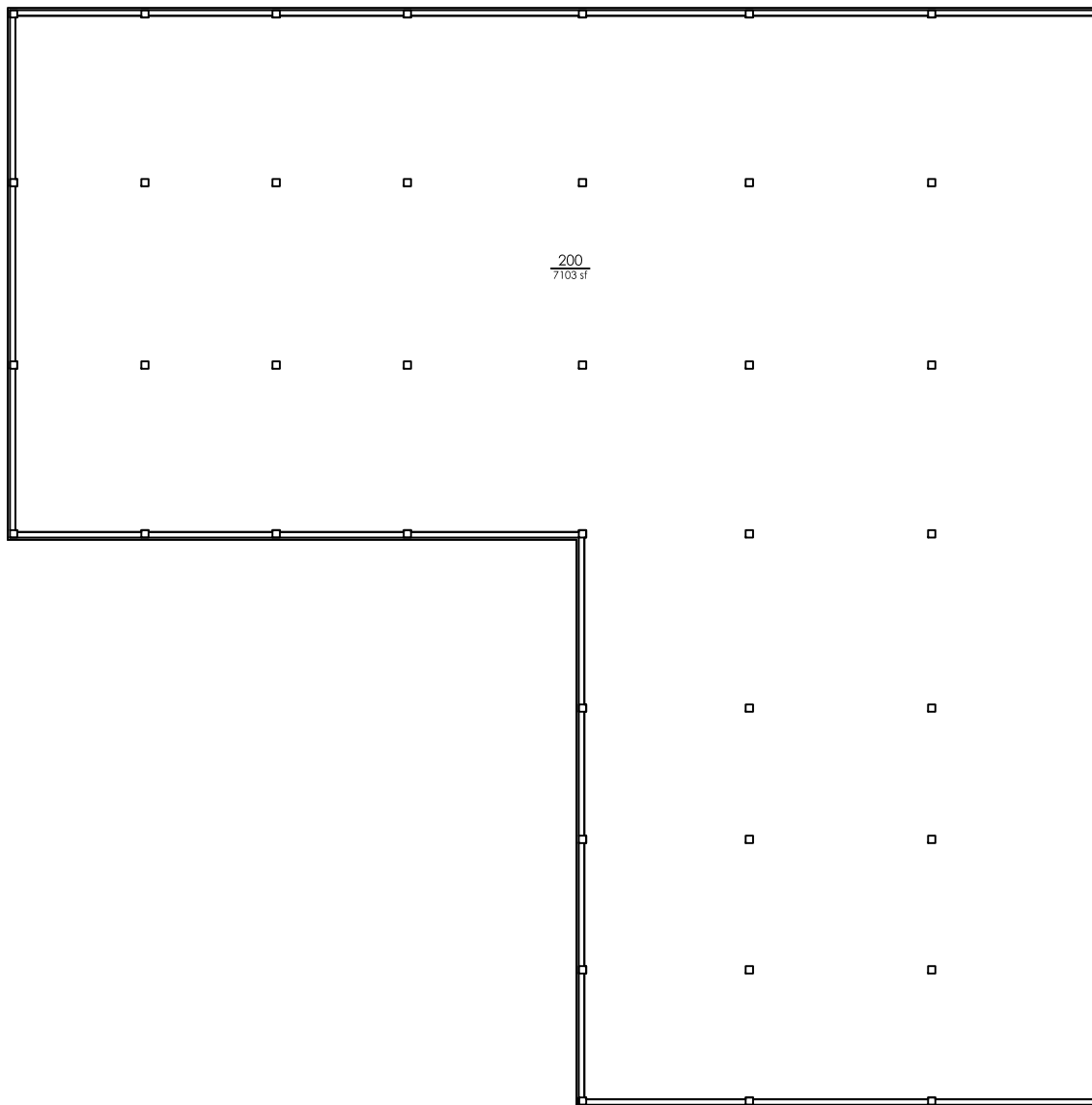
LOFT AREA
RED BARN



 FICM Code 210 Classroom
 FICM Code 110 Classroom

 = FIRE EXTINGUISHER  = AED  = FIRE DEP. CONNECTION  = LOCK BOX  = FIRE ALARM CONTROL PANEL  = SPRINKLER HEADER **R** = SPRINKLER RISER  = Bottle Filler

DATE REVISED 11/16/2020	ADDRESS 609 W 7th St	Square Feet 7833	BLDG NO 1205	(RDB) RED BARN LOFT AREA	FLOOR 2
----------------------------	-------------------------	---------------------	-----------------	-----------------------------	------------

DRAWINGS ARE NOT TO SCALE

FIRST FLOOR
ROZELL PLANT

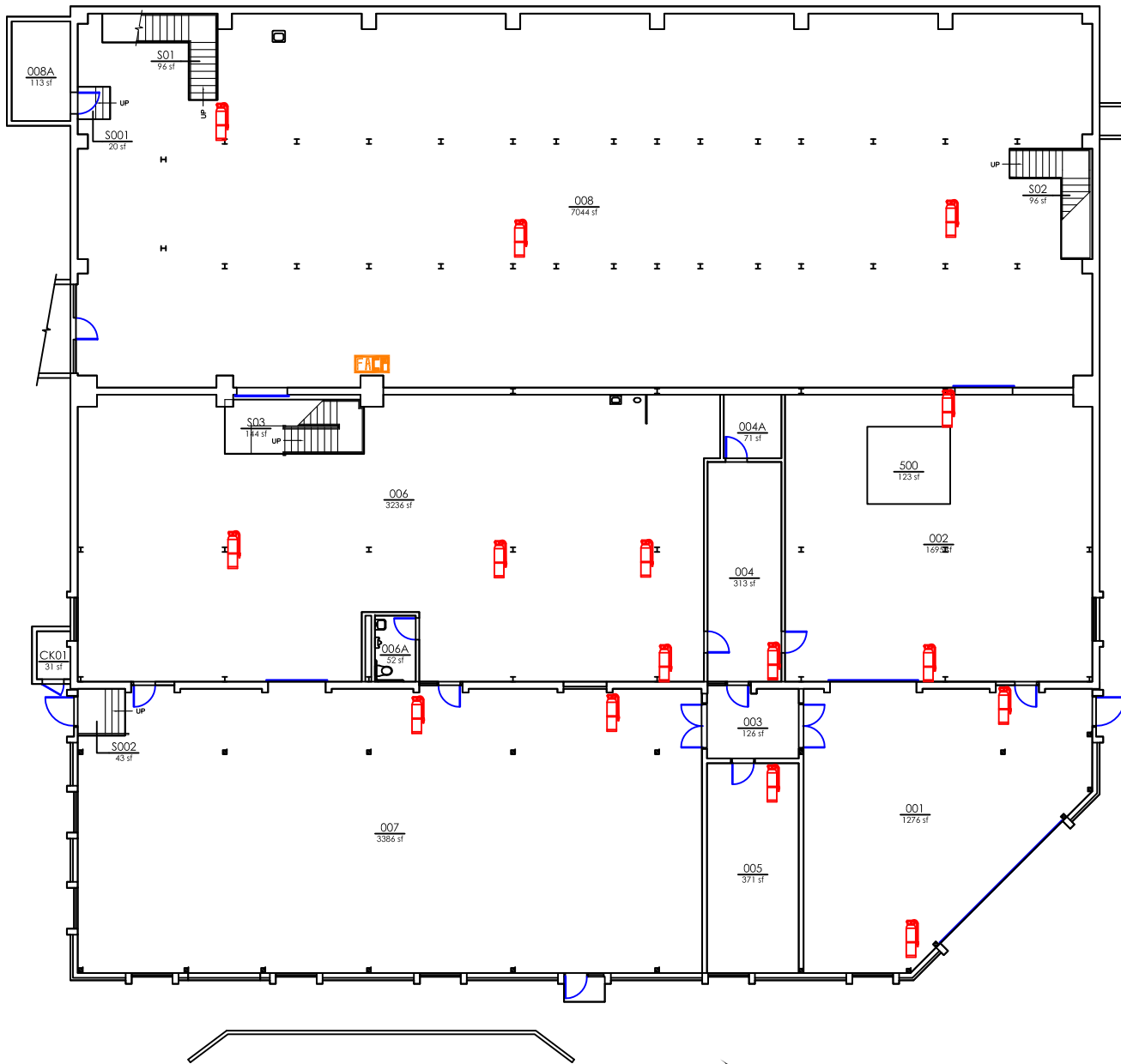

- FICM Code 210 Classroom
- FICM Code 110 Classroom

- = FIRE EXTINGUISHER
- = AED
- = FIRE DEP. CONNECTION
- = LOCK BOX
- = FIRE ALARM CONTROL PANEL
- = SPRINKLER HEADER
- R** = SPRINKLER RISER
- = Bottle Filler

DATE REVISED
11/23/2020

ADDRESS
1115 Cedar St

Square Feet
19153

BLDG NO
1460

(ROZ) ROZELL HEATING PLANT
FIRST FLOOR

FLOOR
1

DRAWINGS ARE NOT TO SCALE

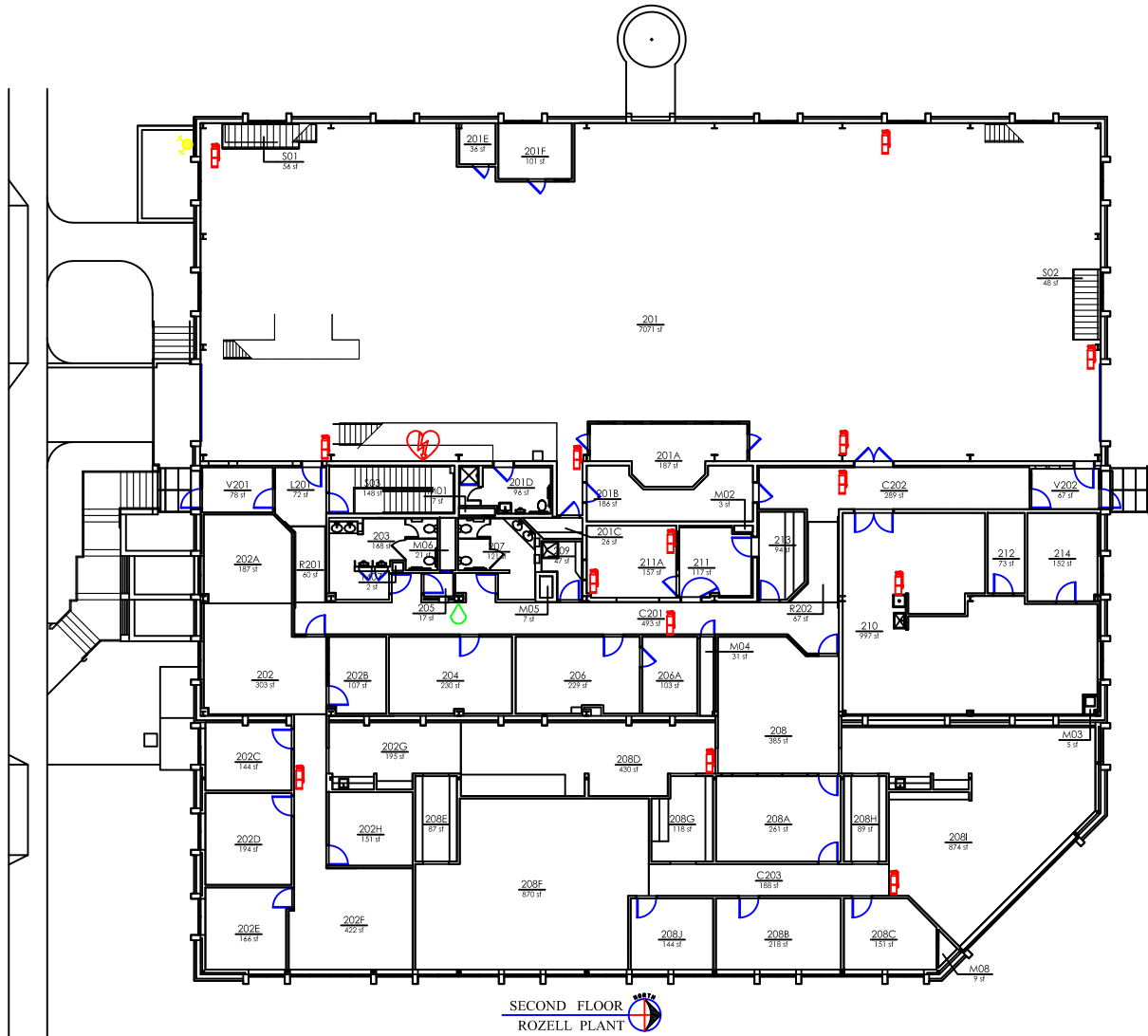

- FICM Code 210 Classroom
- FICM Code 110 Classroom



- = FIRE EXTINGUISHER
- = AED
- = FIRE DEP. CONNECTION
- = LOCK BOX
- = FIRE ALARM CONTROL PANEL
- = SPRINKLER HEADER
- = SPRINKLER RISER
- = Bottle Filler

DATE REVISED 11/23/2020	ADDRESS 1115 Cedar St	Square Feet 18822	BLDG NO 1460	(ROZ) ROZELL HEATING PLANT SECOND FLOOR	FLOOR 2
----------------------------	--------------------------	----------------------	-----------------	--	------------

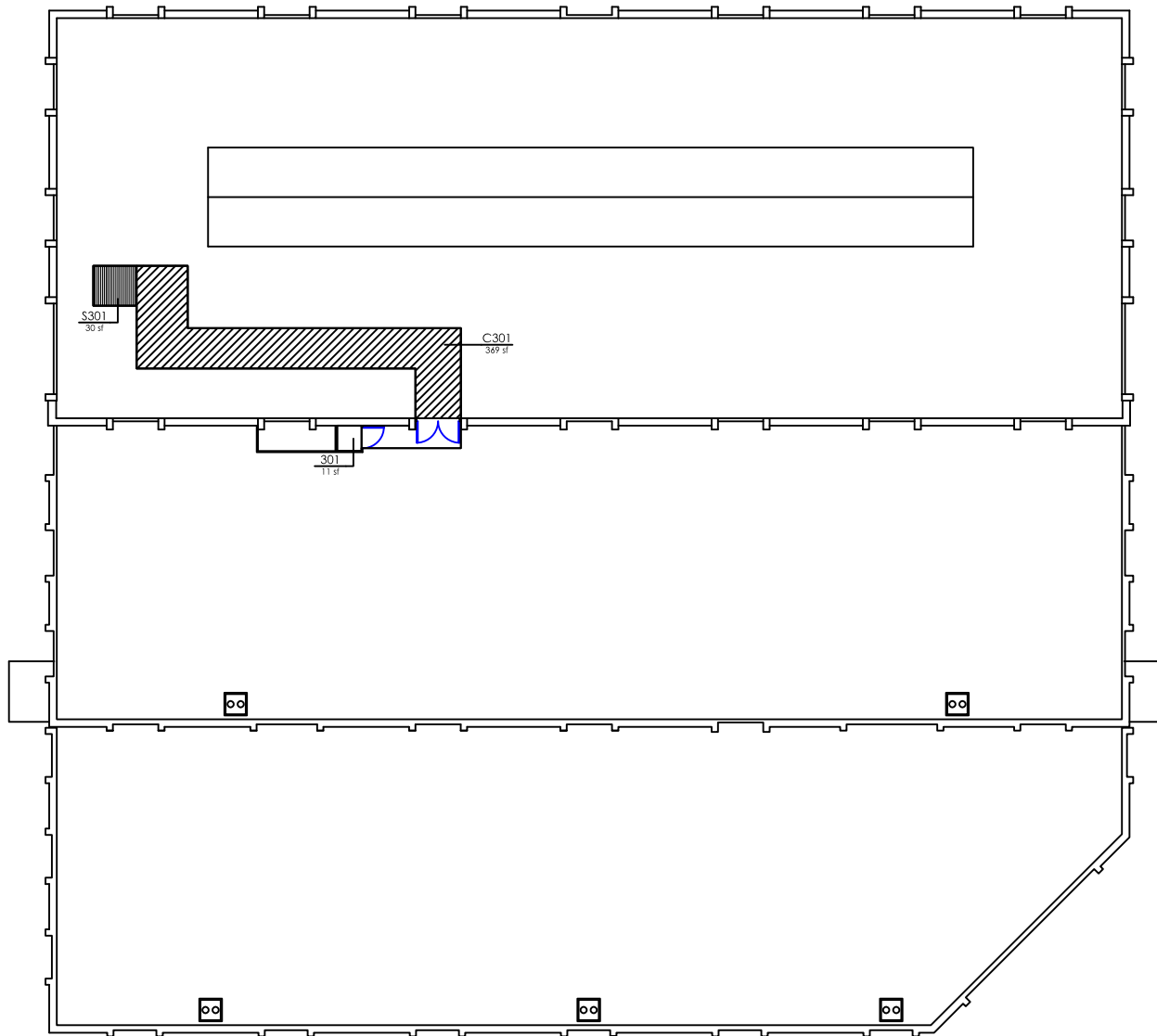
DRAWINGS ARE NOT TO SCALE



ROOF
ROZELL PLANT

 FICM Code 210 Classroom
 FICM Code 110 Classroom

 = FIRE EXTINGUISHER  = AED  = FIRE DEP. CONNECTION  = LOCK BOX  = FIRE ALARM CONTROL PANEL  = SPRINKLER HEADER **R** = SPRINKLER RISER  = Bottle Filler

DATE REVISED
11/24/2020

ADDRESS
1115 Cedar St

Square Feet
410

BLDG NO
1460



(ROZ) ROZELL HEATING PLANT
THIRD FLOOR

FLOOR
3

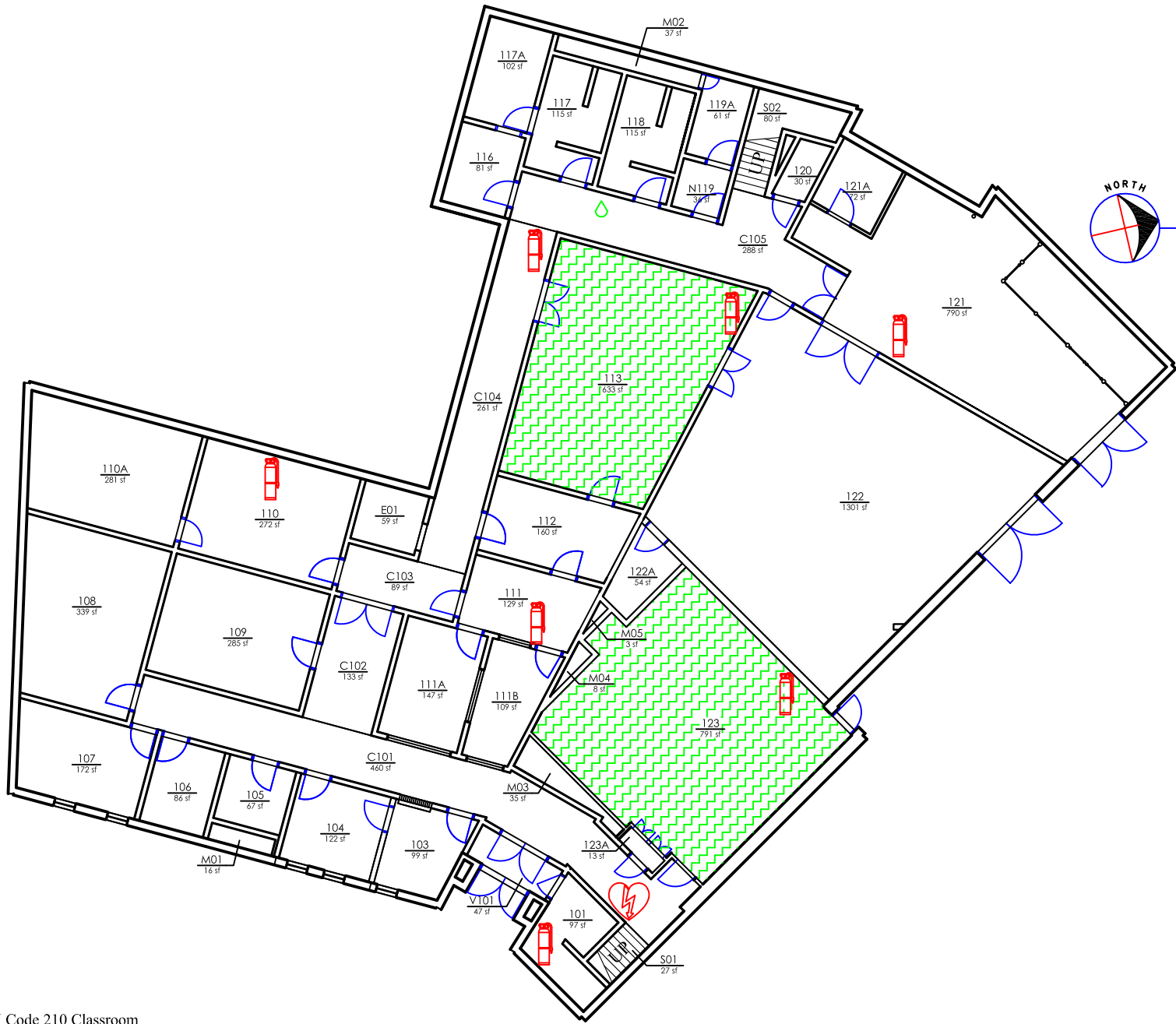
DRAWINGS ARE NOT TO SCALE



FIRST FLOOR
RADIO/TV BUILDING

 FICM Code 210 Classroom
 FICM Code 110 Classroom

 = FIRE EXTINGUISHER  = AED  = FIRE DEP. CONNECTION  = LOCK BOX  = FIRE ALARM CONTROL PANEL  = SPRINKLER HEADER **R** = SPRINKLER RISER  = Bottle Filler

DATE REVISED
08/11/2020

ADDRESS
1029 Washington Street

Square Feet
9183



BLDG NO
1148

(RTV) RADIO TV BUILDING
FIRST FLOOR

FLOOR
1

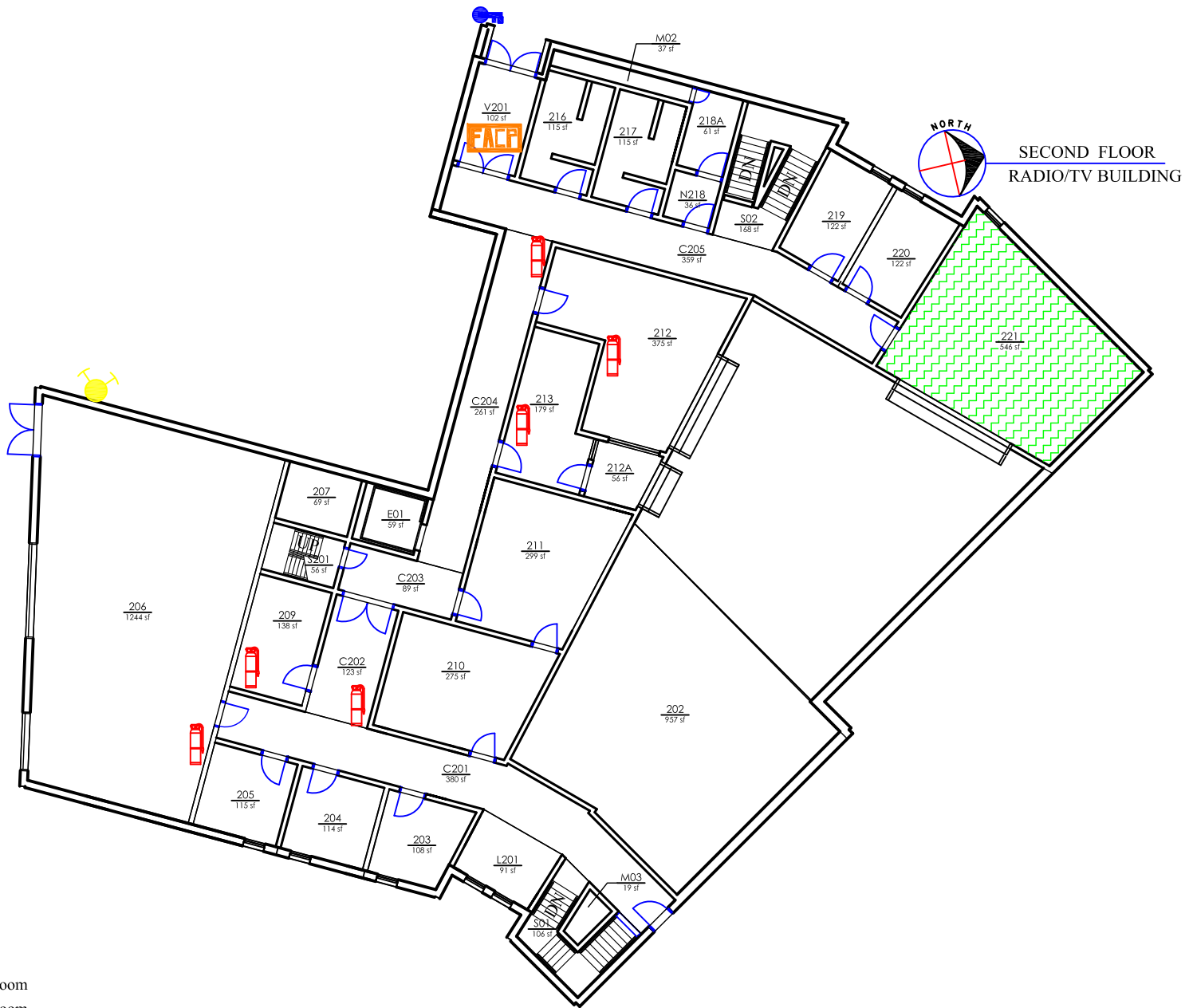
DRAWINGS ARE NOT TO SCALE



 FICM Code 210 Classroom
 FICM Code 110 Classroom

 = FIRE EXTINGUISHER  = AED  = FIRE DEP. CONNECTION  = LOCK BOX  = FIRE ALARM CONTROL PANEL  = SPRINKLER HEADER **R** = SPRINKLER RISER  = Bottle Filler

DATE REVISED
08/11/2020

ADDRESS
1029 Washington Street

Square Feet
7797



BLDG NO
1148

(RTV) RADIO TV BUILDING
SECOND FLOOR

FLOOR
2

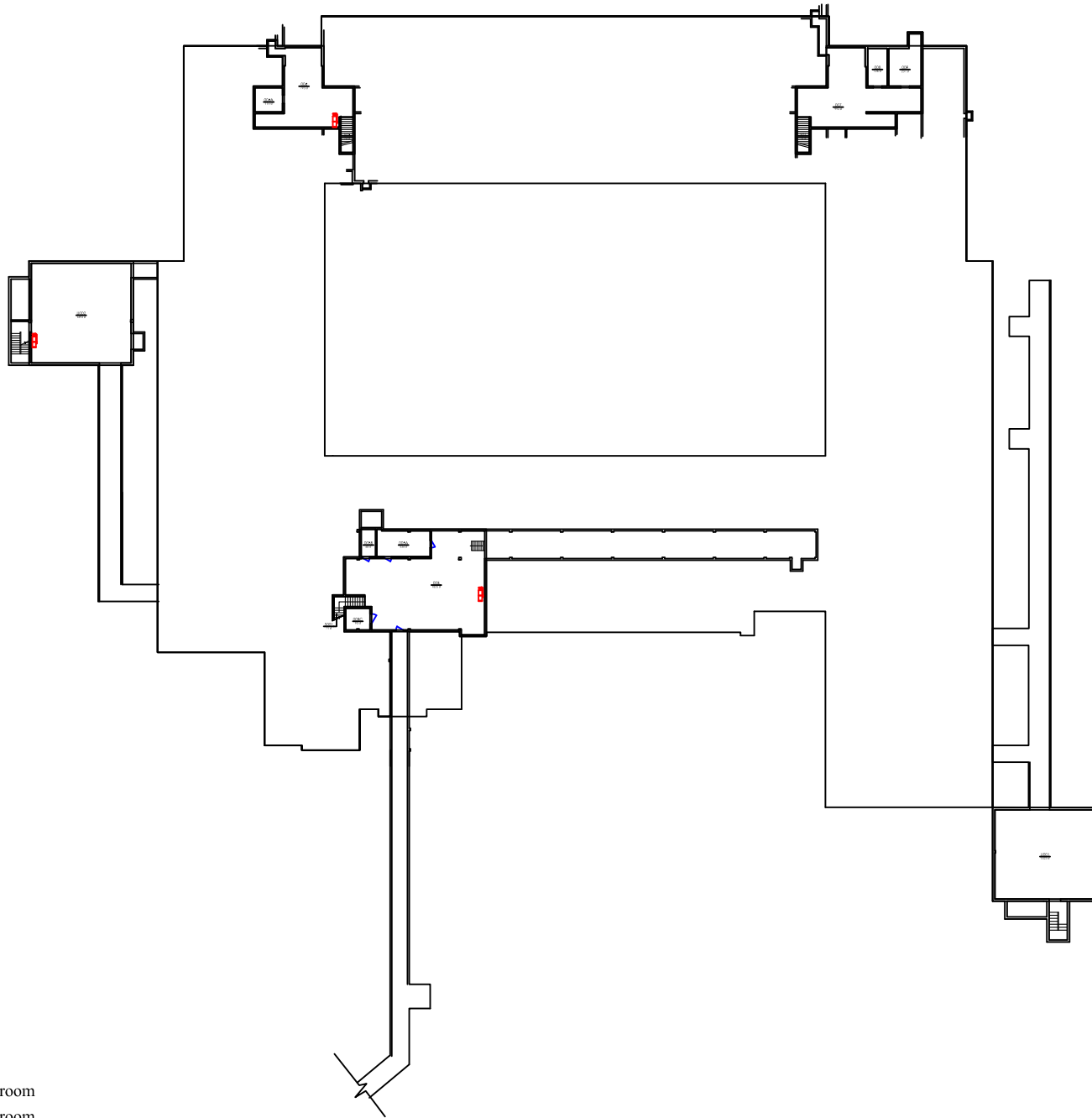
DRAWINGS ARE NOT TO SCALE





-  FICM Code 210 Classroom
-  FICM Code 110 Classroom

-  = FIRE EXTINGUISHER
-  = AED
-  = FIRE DEP. CONNECTION
-  = LOCK BOX
-  = FIRE ALARM CONTROL PANEL
-  = SPRINKLER HEADER
-  = SPRINKLER RISER
-  = Bottle Filler

DATE REVISED	ADDRESS	Square Feet	BLDG NO	(SCI) SCIENCE BUILDING BASEMENT	FLOOR
09/17/2020	1175 Washington ST	8754	1166		0

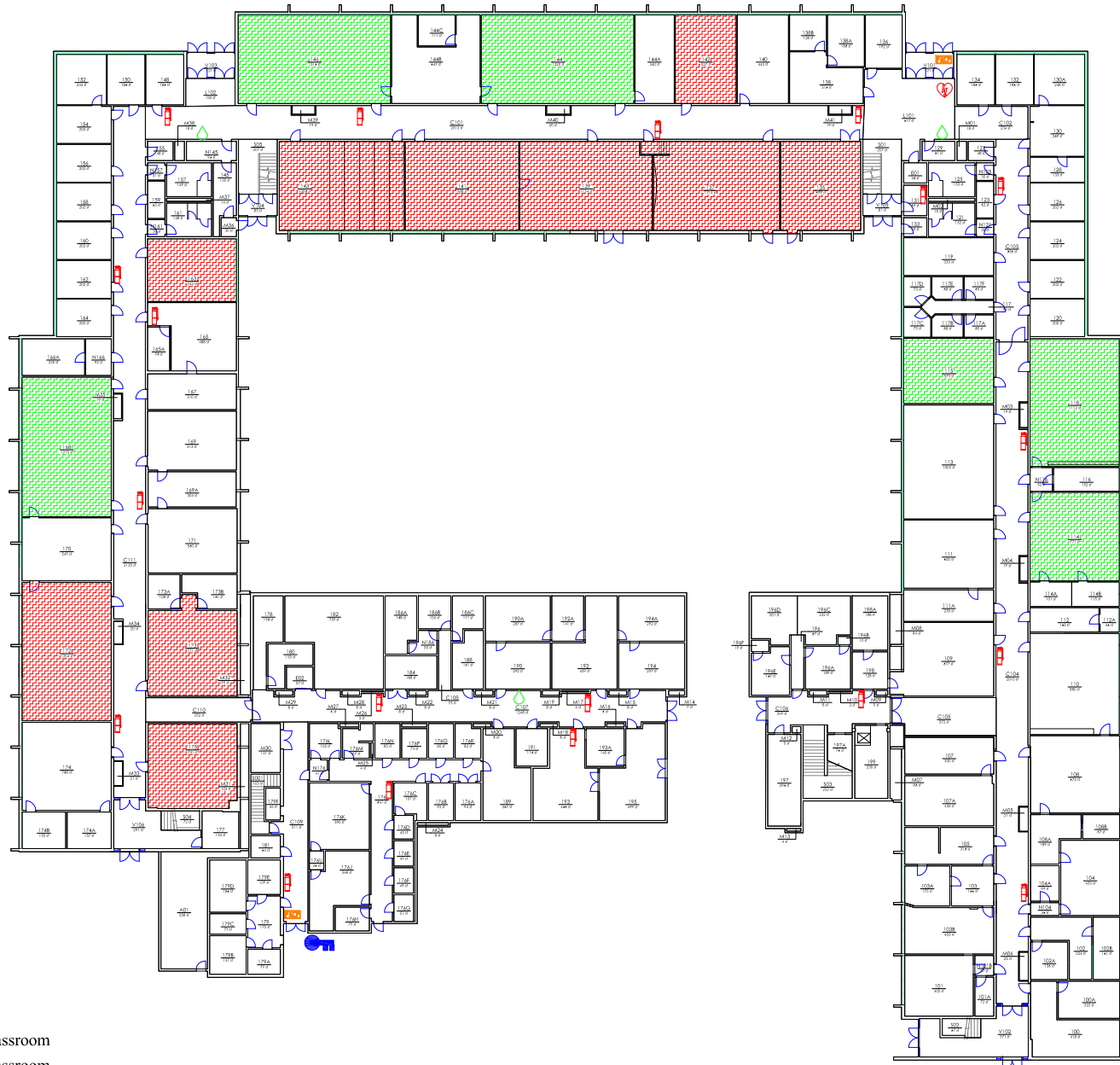
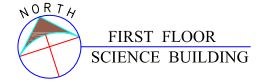
DRAWINGS ARE NOT TO SCALE





 FICM Code 210 Classroom
 FICM Code 110 Classroom

 = FIRE EXTINGUISHER  = AED  = FIRE DEP. CONNECTION  = LOCK BOX  = FIRE ALARM CONTROL PANEL  = SPRINKLER HEADER  = SPRINKLER RISER  = Bottle Filler

DATE REVISED 02/01/2022	ADDRESS 1175 Washington ST	Square Feet 67191	BLDG NO 1166	(SCI) SCIENCE BUILDING FIRST FLOOR	FLOOR 1
----------------------------	-------------------------------	----------------------	-----------------	---------------------------------------	------------

DRAWINGS ARE NOT TO SCALE



 FICM Code 210 Classroom
 FICM Code 110 Classroom

 = FIRE EXTINGUISHER  = AED  = FIRE DEP. CONNECTION  = LOCK BOX  = FIRE ALARM CONTROL PANEL  = SPRINKLER HEADER **R** = SPRINKLER RISER  = Bottle Filler

DATE REVISED
09/17/2020

ADDRESS
1175 Washington ST

Square Feet
66842

BLDG NO
1166

(SCI) SCIENCE BUILDING
SECOND FLOOR

FLOOR
2

DRAWINGS ARE NOT TO SCALE

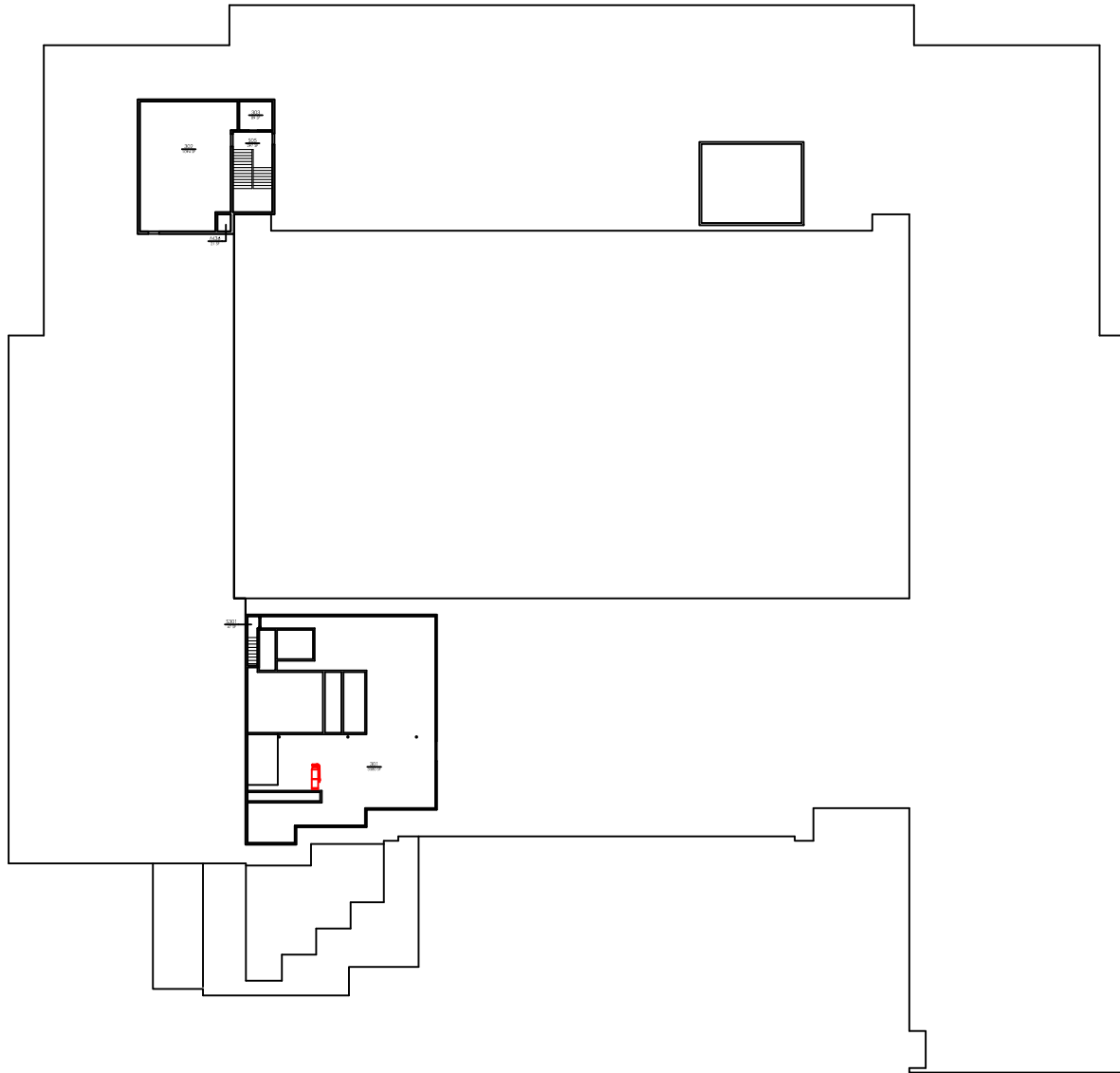
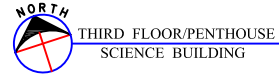

FICM Code 210 Classroom
 FICM Code 110 Classroom

= FIRE EXTINGUISHER = AED = FIRE DEP. CONNECTION = LOCK BOX = FIRE ALARM CONTROL PANEL = SPRINKLER HEADER **R** = SPRINKLER RISER = Bottle Filler

DATE REVISED
1/19/2021

ADDRESS
1175 Washington
ST

Square Feet
5425

BLDG NO
1166

(SCI) SCIENCE BUILDING
THIRD FLOOR

FLOOR
3

DRAWINGS ARE NOT TO SCALE

FLOOR PLAN
RESEARCH GREENHOUSE

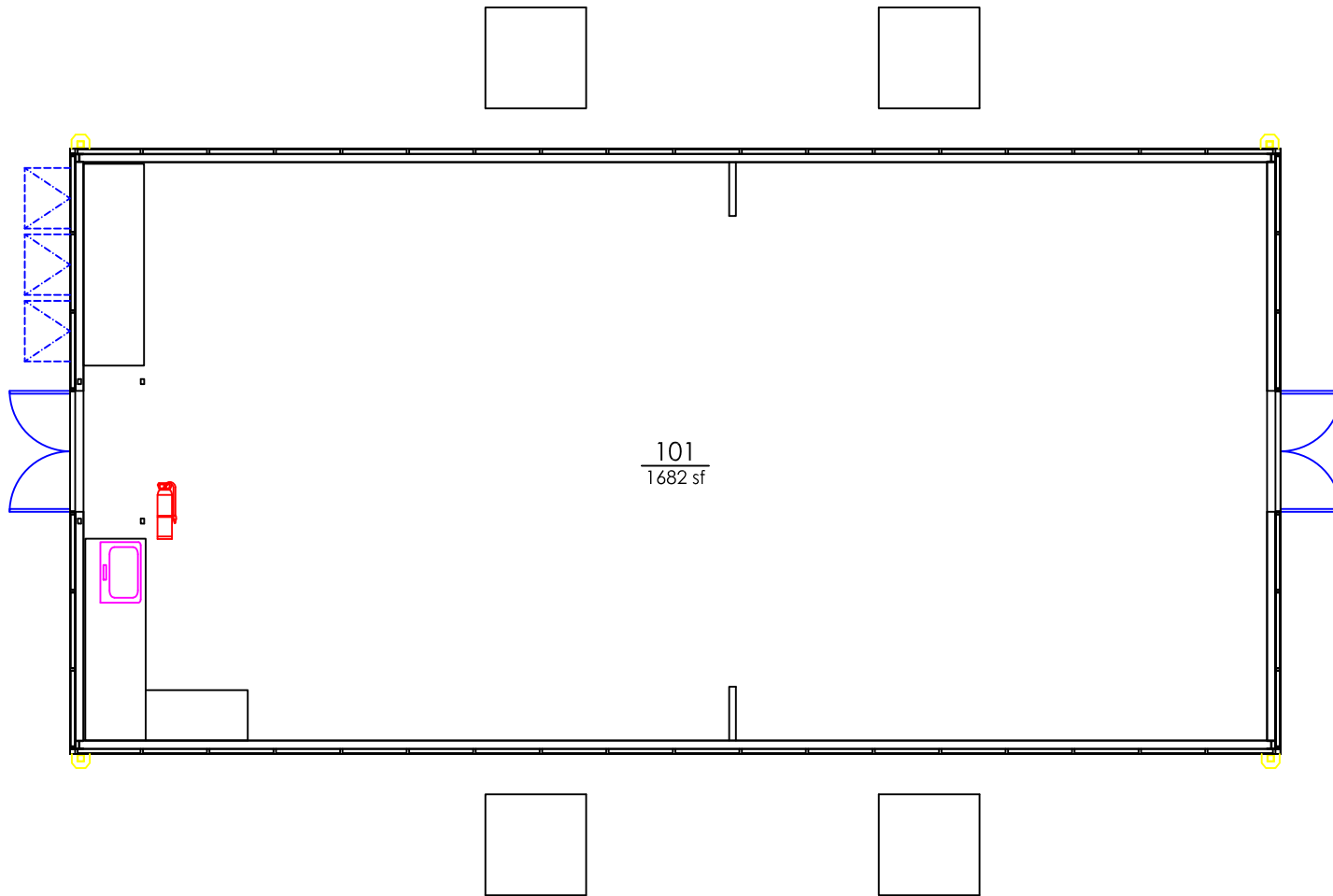
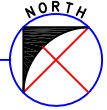

- FICM Code 210 Classroom
- FICM Code 110 Classroom

- = FIRE EXTINGUISHER
- = AED
- = FIRE DEP. CONNECTION
- = LOCK BOX
- = FIRE ALARM CONTROL PANEL
- = SPRINKLER HEADER
- = SPRINKLER RISER
- = Bottle Filler

DATE REVISED
11/24/2020

ADDRESS
1400 Woodward
Ln

Square Feet
1754

BLDG NO
1420



(SGB) RESEARCH GREENHOUSE
FLOOR PLAN

FLOOR
1

DRAWINGS ARE NOT TO SCALE

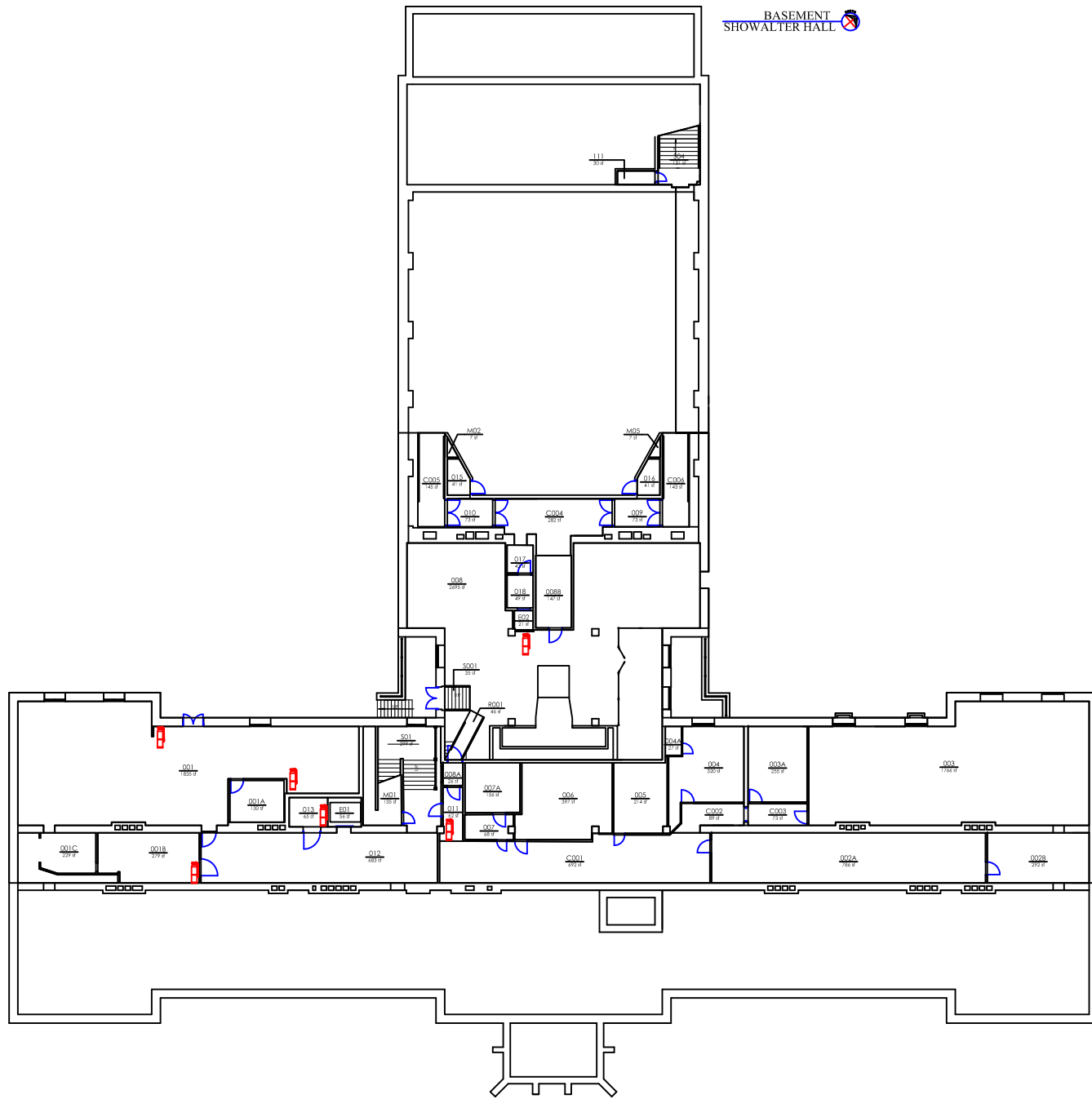
BASEMENT
SHOWALTER HALL



-  FICM Code 210 Classroom
-  FICM Code 110 Classroom

-  = FIRE EXTINGUISHER
-  = AED
-  = FIRE DEP. CONNECTION
-  = LOCK BOX
-  = FIRE ALARM CONTROL PANEL
-  = SPRINKLER HEADER
-  = SPRINKLER RISER
-  = Bottle Filler

DATE REVISED
09/02/2020

ADDRESS
526 5th Street

Square Feet
14755

BLDG NO
1103

(SHW) SHOWALTER HALL
BASEMENT



FLOOR
0

DRAWINGS ARE NOT TO SCALE

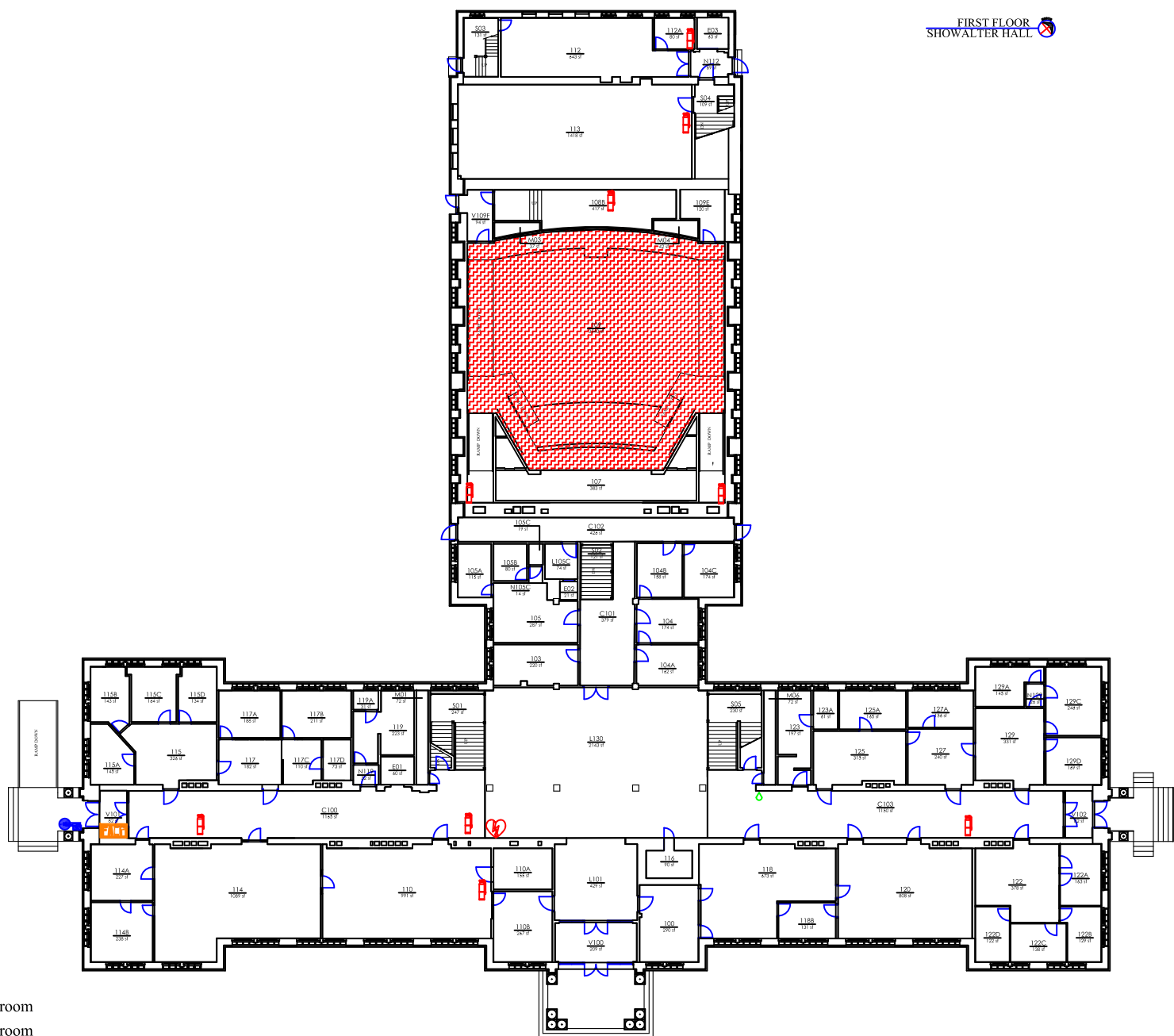

FIRST FLOOR
SHOWALTER HALL





 FICM Code 210 Classroom
 FICM Code 110 Classroom

 = FIRE EXTINGUISHER  = AED  = FIRE DEP. CONNECTION  = LOCK BOX  = FIRE ALARM CONTROL PANEL  = SPRINKLER HEADER **R** = SPRINKLER RISER  = Bottle Filler

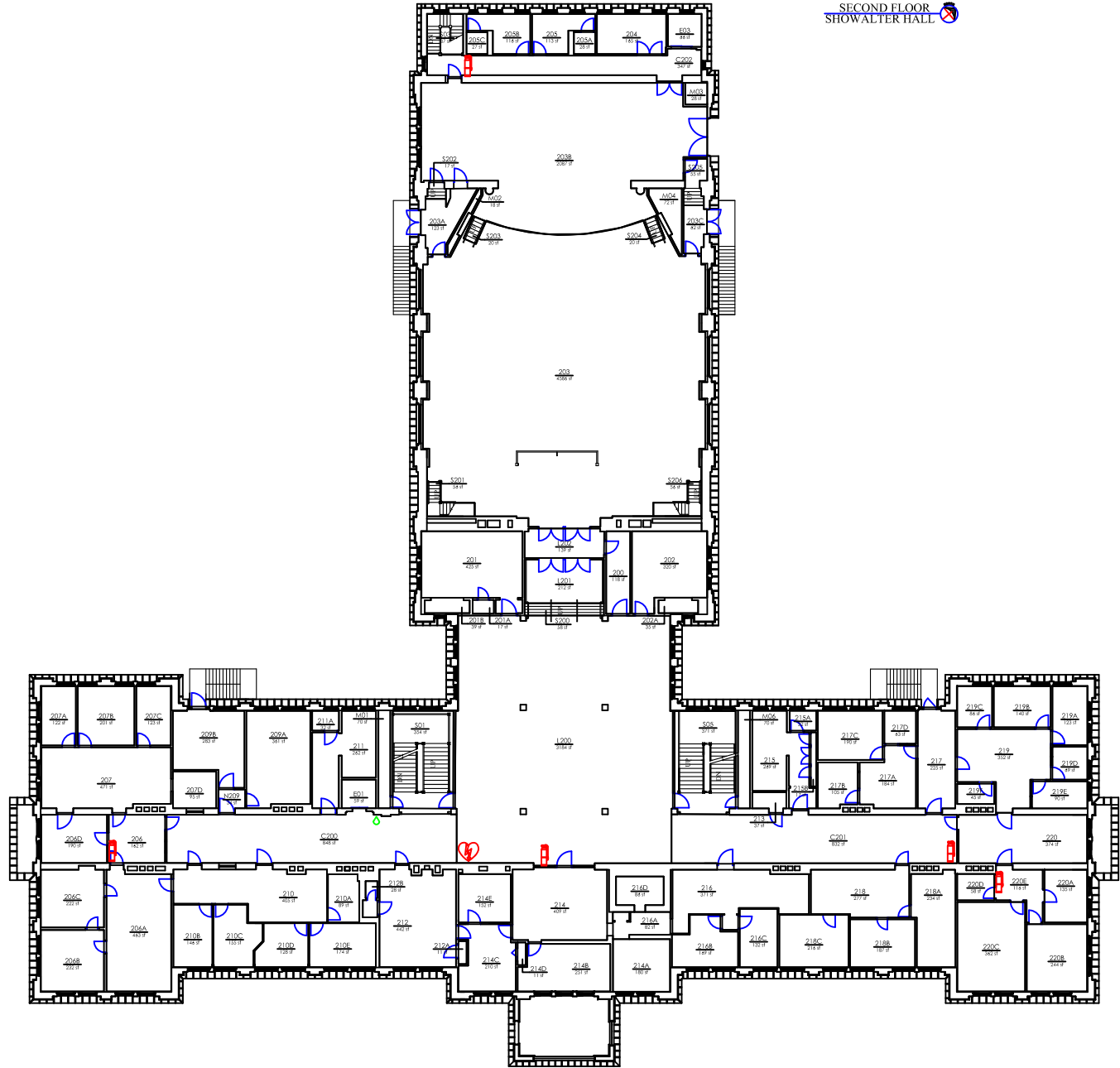
DATE REVISED 09/02/2020	ADDRESS 526 5th Street	Square Feet 30413	BLDG NO 1103	(SHW) SHOWALTER HALL FIRST FLOOR	FLOOR 1
----------------------------	---------------------------	----------------------	-----------------	-------------------------------------	------------





 FICM Code 210 Classroom
 FICM Code 110 Classroom

 = FIRE EXTINGUISHER  = AED  = FIRE DEP. CONNECTION  = LOCK BOX  = FIRE ALARM CONTROL PANEL  = SPRINKLER HEADER **R** = SPRINKLER RISER  = Bottle Filler

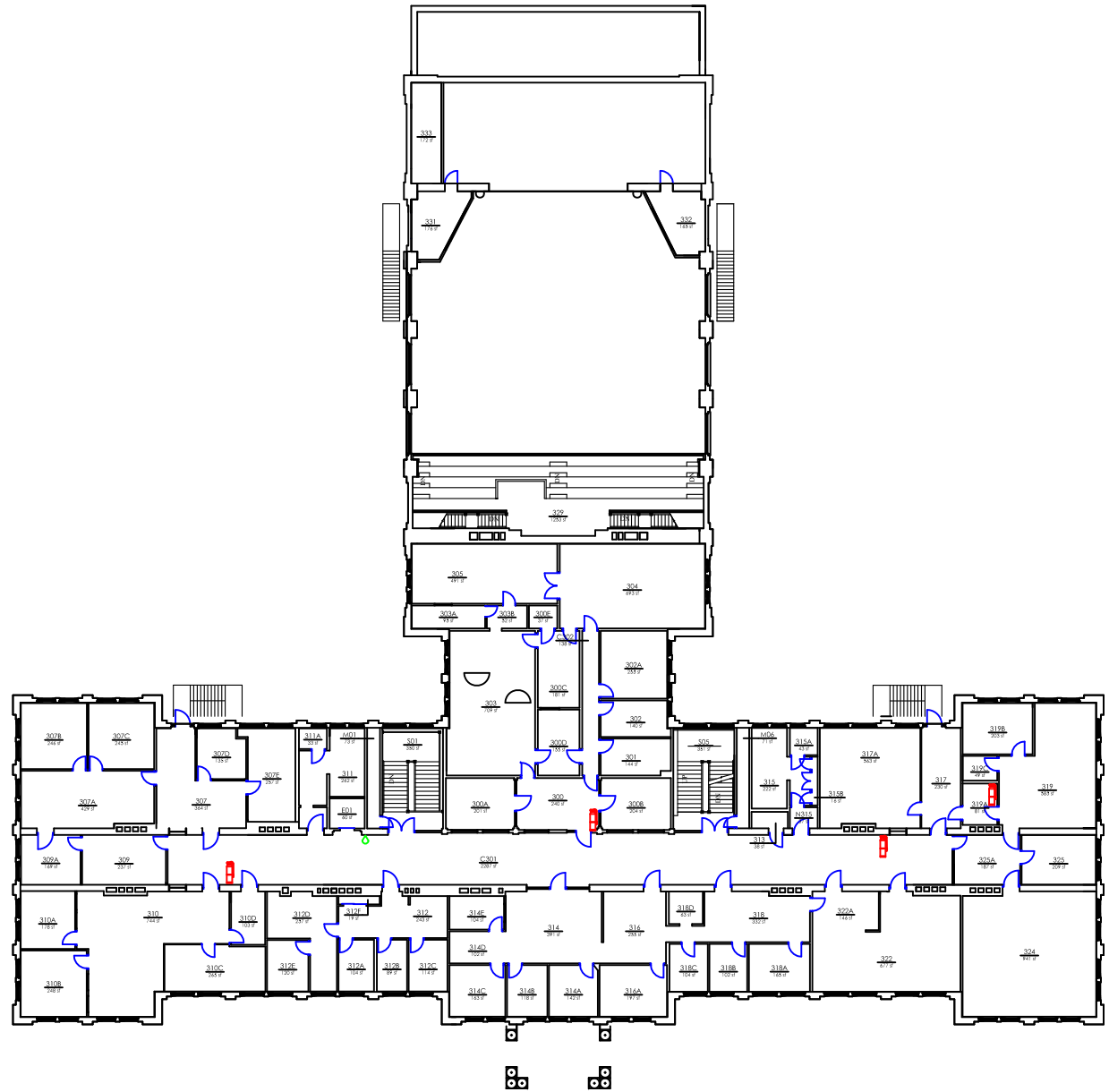
DATE REVISED 09/04/2020	ADDRESS 526 5th Street	Square Feet 29747	BLDG NO 1103	(SHW) SHOWALTER HALL SECOND FLOOR	FLOOR 2
----------------------------	---------------------------	----------------------	-----------------	--------------------------------------	------------



 FICM Code 210 Classroom
 FICM Code 110 Classroom

 = FIRE EXTINGUISHER  = AED  = FIRE DEP. CONNECTION  = LOCK BOX  = FIRE ALARM CONTROL PANEL  = SPRINKLER HEADER **R** = SPRINKLER RISER  = Bottle Filler

DATE REVISED
09/04/2020

ADDRESS
526 5th Street

Square Feet
22784

BLDG NO
1103



(SHW) SHOWALTER HALL
THIRD FLOOR

FLOOR
3

DRAWINGS ARE NOT TO SCALE

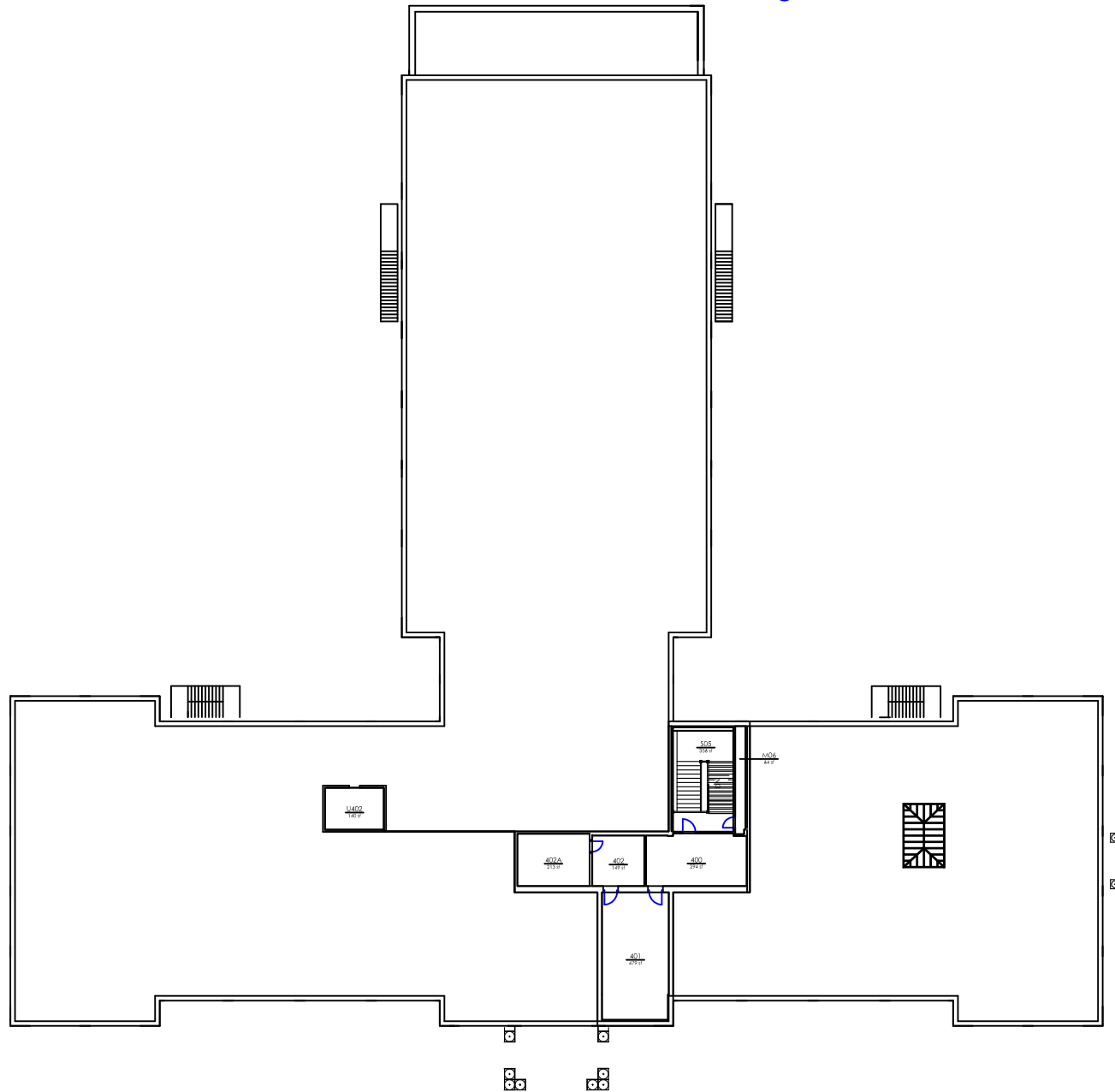
FOURTH FLOOR PLAN
SHOWALTER HALL



 FICM Code 210 Classroom
 FICM Code 110 Classroom

 = FIRE EXTINGUISHER  = AED  = FIRE DEP. CONNECTION  = LOCK BOX  = FIRE ALARM CONTROL PANEL  = SPRINKLER HEADER  = SPRINKLER RISER  = Bottle Filler

DATE REVISED
09/04/2020

ADDRESS
526 5th Street

Square Feet
2024

BLDG NO
1103

(SHW) SHOWALTER HALL
FOURTH FLOOR

FLOOR
4

DRAWINGS ARE NOT TO SCALE



BASEMENT
SENIOR HALL

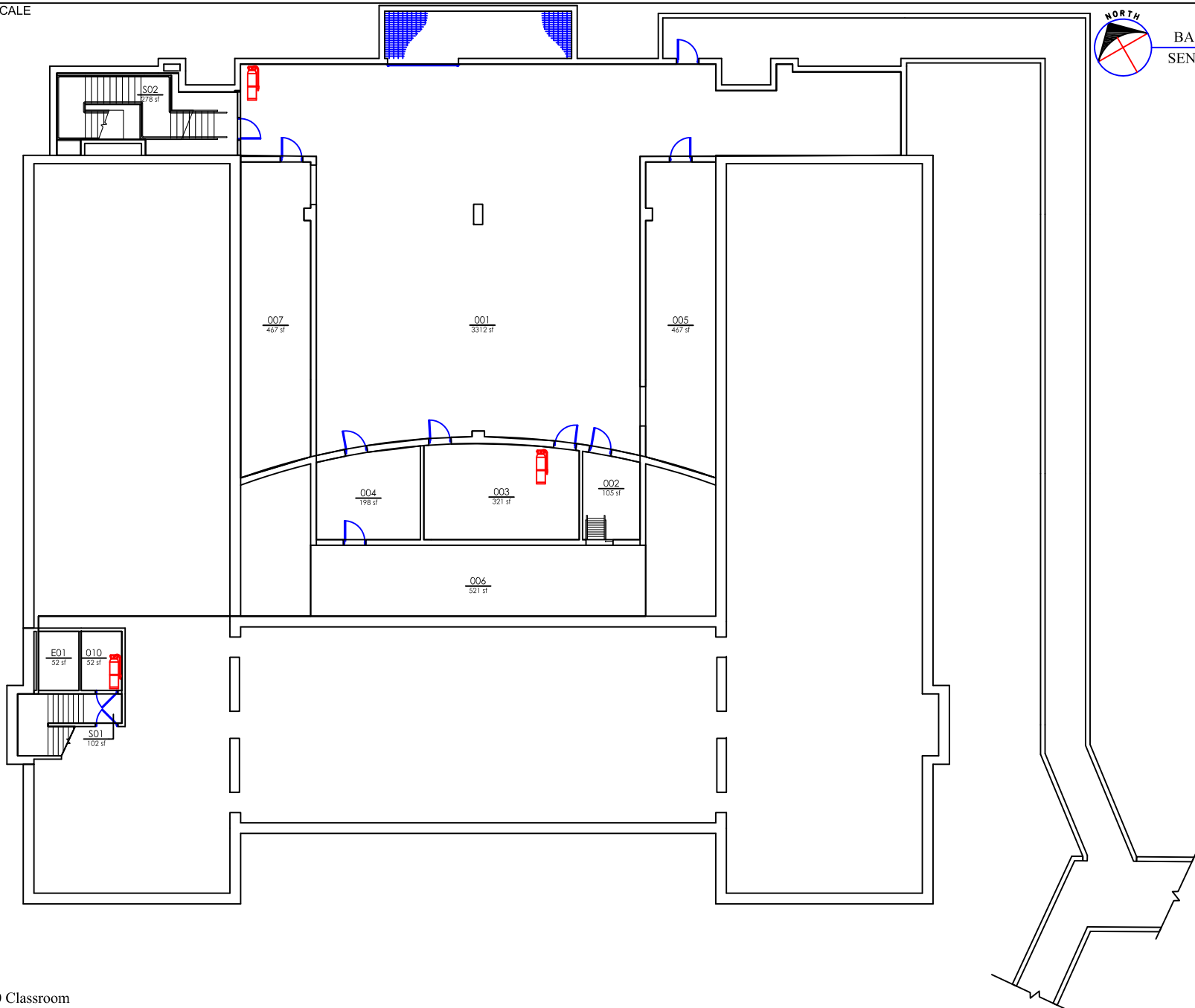

- FICM Code 210 Classroom
- FICM Code 110 Classroom

- = FIRE EXTINGUISHER
- = AED
- = FIRE DEP. CONNECTION
- = LOCK BOX
- = FIRE ALARM CONTROL PANEL
- = SPRINKLER HEADER
- = SPRINKLER RISER
- = Bottle Filler

DATE REVISED
08/12/2020

ADDRESS
612 C Street

Square Feet
6087

BLDG NO
1187

(SNR) SENIOR HALL
BASEMENT

FLOOR
0



FIRST FLOOR
SENIOR HALL

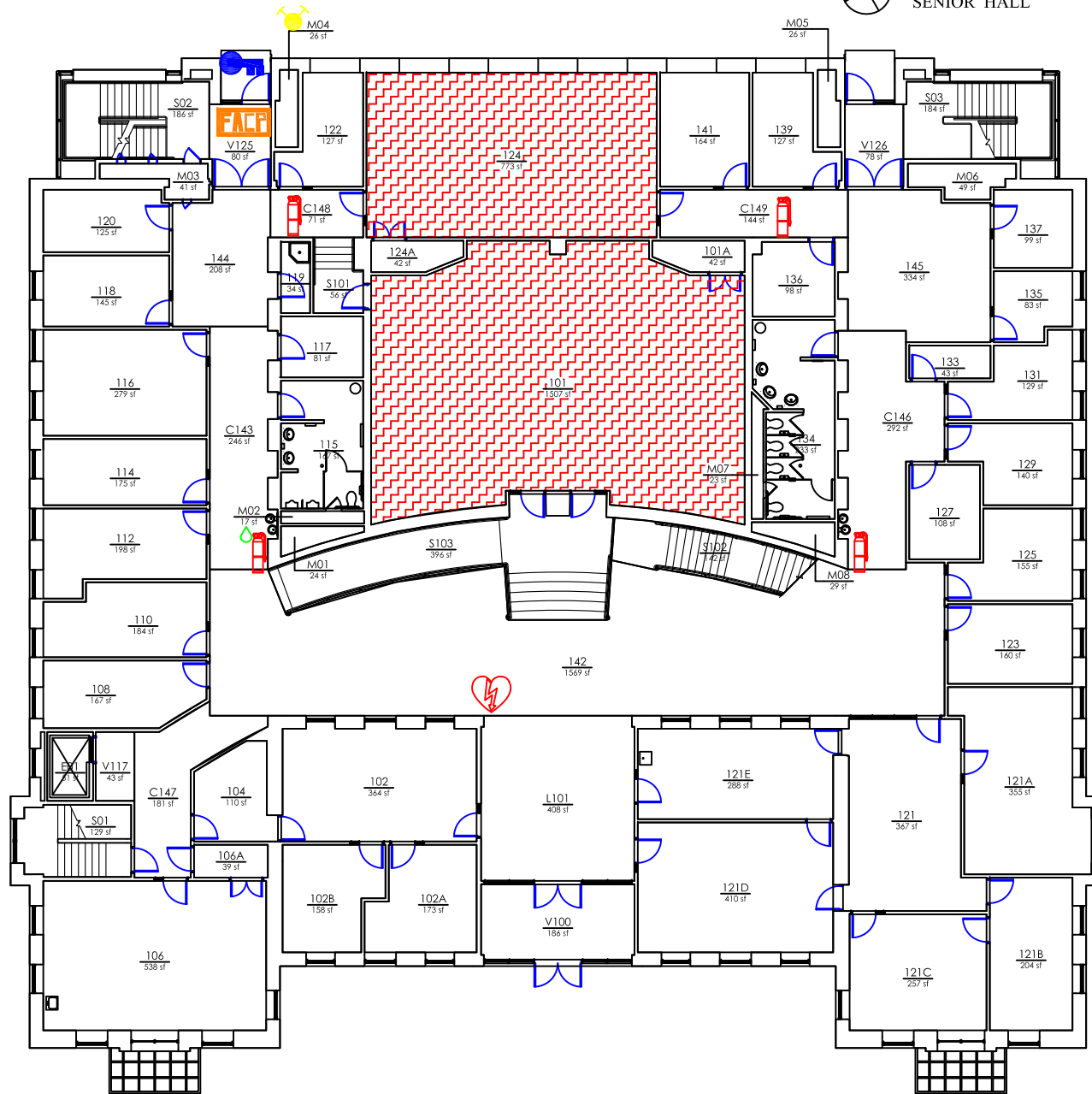

- FICM Code 210 Classroom
- FICM Code 110 Classroom

- = FIRE EXTINGUISHER
- = AED
- = FIRE DEP. CONNECTION
- = LOCK BOX
- = FIRE ALARM CONTROL PANEL
- = SPRINKLER HEADER
- = SPRINKLER RISER
- = Bottle Filler

DATE REVISED
08/19/2020

ADDRESS
612 C Street

Square Feet
16006

BLDG NO
1187



(SNR) SENIOR HALL
FIRST FLOOR

FLOOR
1

DRAWINGS ARE NOT TO SCALE

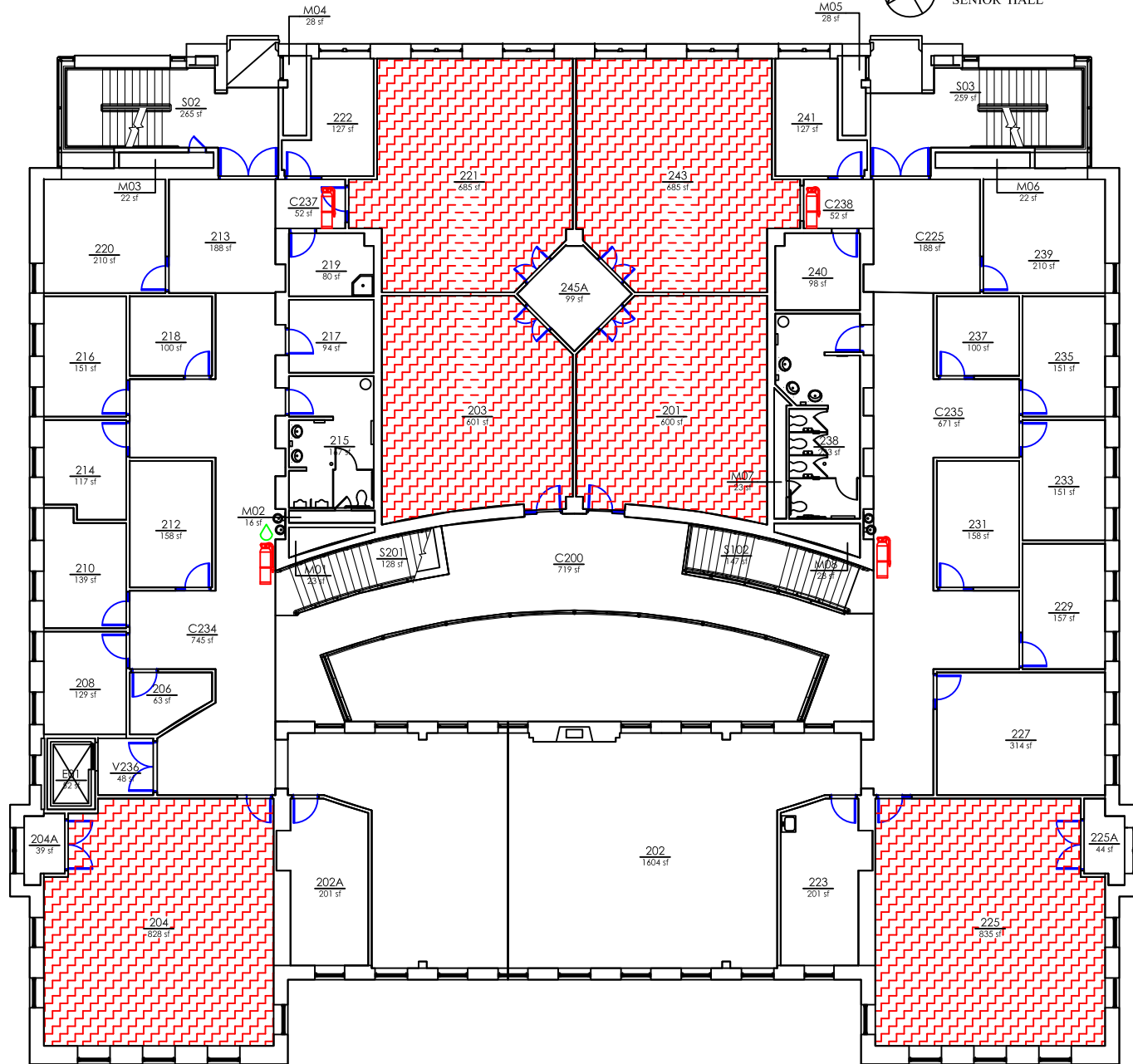
NORTH
SECOND FLOOR
SENIOR HALL



 FICM Code 210 Classroom
 FICM Code 110 Classroom

 = FIRE EXTINGUISHER  = AED  = FIRE DEP. CONNECTION  = LOCK BOX  = FIRE ALARM CONTROL PANEL  = SPRINKLER HEADER **R** = SPRINKLER RISER  = Bottle Filler

DATE REVISED
08/19/2020

ADDRESS
612 C Street

Square Feet
15203

BLDG NO
1187

(SNR) SENIOR HALL
FIRST FLOOR

FLOOR
2

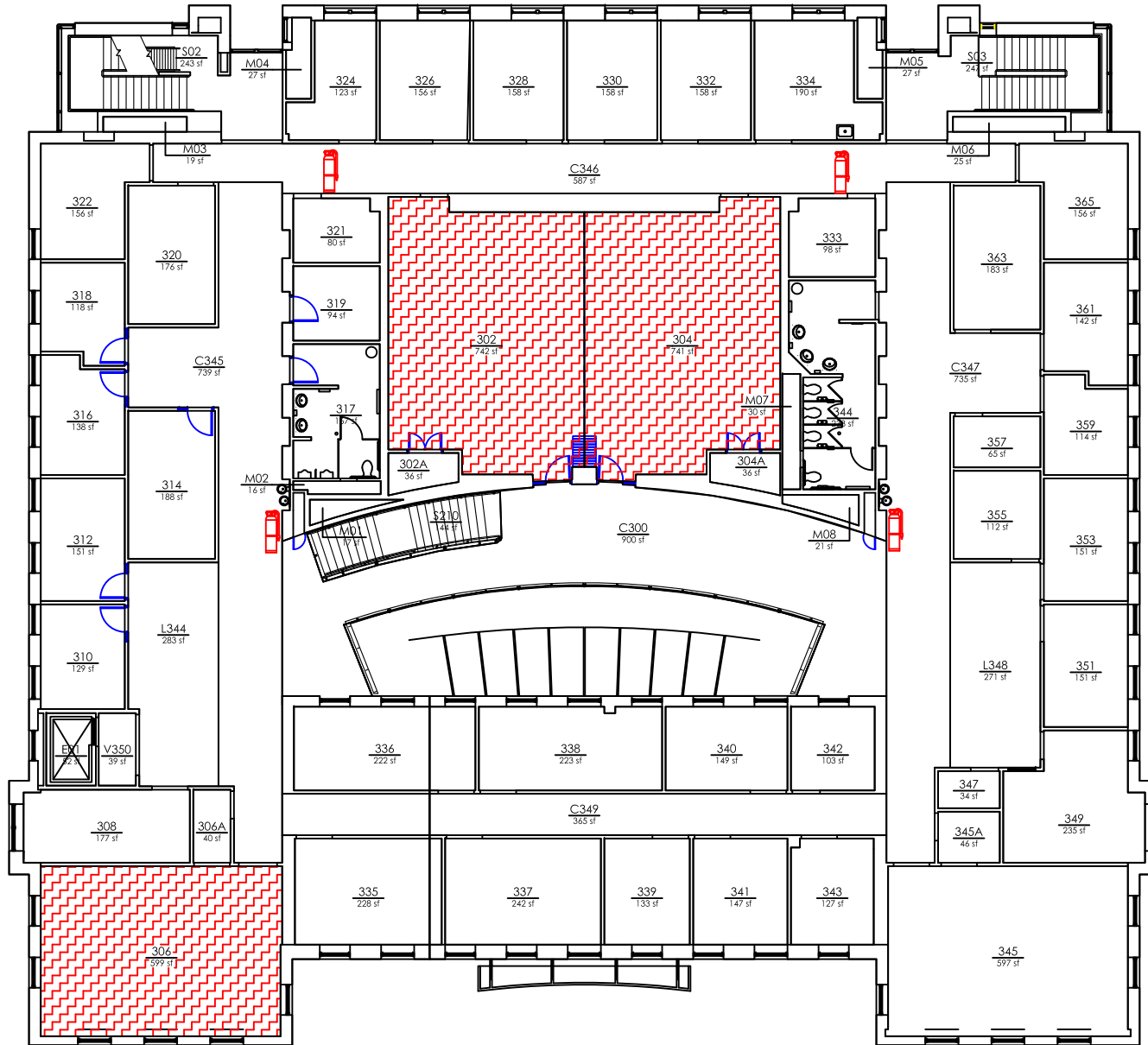

FICM Code 210 Classroom
 FICM Code 110 Classroom

= FIRE EXTINGUISHER = AED = FIRE DEP. CONNECTION = LOCK BOX = FIRE ALARM CONTROL PANEL = SPRINKLER HEADER **R** = SPRINKLER RISER = Bottle Filler

DATE REVISED
09/02/2020

ADDRESS
612 C Street

Square Feet
15322

BLDG NO
1187

**(SNR) SENIOR HALL
THIRD FLOOR**

FLOOR
3

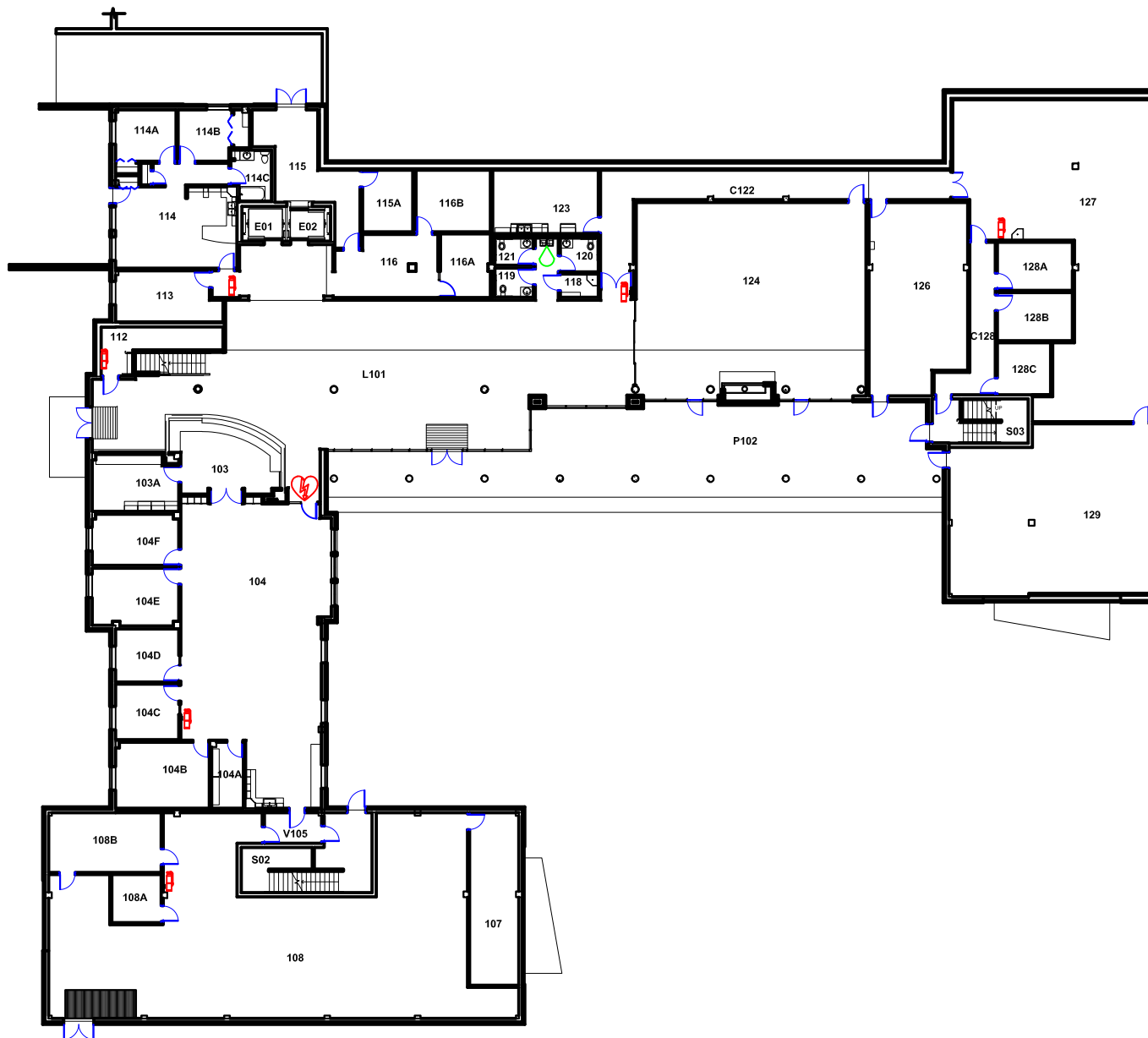

= FIRE EXTINGUISHER
 = AED
 = FIRE DEP. CONNECTION
 = LOCK BOX
 = FIRE ALARM CONTROL PANEL
 = SPRINKLER HEADER
 = SPRINKLER RISER
 = WATER BOTTLE FILLER

DATE CREATED
02-15-19

ADDRESS
1027 Cedar Street

Square Feet
21421



AiM ID
1467

(SNY) SNYAMNCUT
FIRST FLOOR

FLOOR
1

DRAWINGS ARE NOT TO SCALE



-  FICM Code 210 Classroom
-  FICM Code 110 Classroom

-  = FIRE EXTINGUISHER
-  = AED
-  = FIRE DEP. CONNECTION
-  = LOCK BOX
-  = FIRE ALARM CONTROL PANEL
-  = SPRINKLER HEADER
-  = SPRINKLER RISER
-  = Bottle Filler

DATE REVISED
11/29/2020

ADDRESS
1027 Cedar St

Square Feet
20994



BLDG NO
1467

(SNY) SNYAMNCUT
SECOND FLOOR

FLOOR
2

DRAWINGS ARE NOT TO SCALE



-  FICM Code 210 Classroom
-  FICM Code 110 Classroom

-  = FIRE EXTINGUISHER
-  = AED
-  = FIRE DEP. CONNECTION
-  = LOCK BOX
-  = FIRE ALARM CONTROL PANEL
-  = SPRINKLER HEADER
-  = SPRINKLER RISER
-  = Bottle Filler

DATE REVISED
11/29/2020

ADDRESS
1027 Cedar St

Square Feet
20883



BLDG NO
1467

(SNY) SNYAMNCUT
THIRD FLOOR

FLOOR
3

DRAWINGS ARE NOT TO SCALE



-  FICM Code 210 Classroom
-  FICM Code 110 Classroom

-  = FIRE EXTINGUISHER
-  = AED
-  = FIRE DEP. CONNECTION
-  = LOCK BOX
-  = FIRE ALARM CONTROL PANEL
-  = SPRINKLER HEADER
- R** = SPRINKLER RISER
-  = Bottle Filler

DATE REVISED
11/30/2020

ADDRESS
1027 Cedar St

Square Feet
20883



BLDG NO
1467

(SNY) SNYAMNCUT
FOURTH FLOOR

FLOOR
4

DRAWINGS ARE NOT TO SCALE



 FICM Code 210 Classroom
 FICM Code 110 Classroom

 = FIRE EXTINGUISHER  = AED  = FIRE DEP. CONNECTION  = LOCK BOX  = FIRE ALARM CONTROL PANEL  = SPRINKLER HEADER **R** = SPRINKLER RISER  = Bottle Filler

DATE REVISED 11/30/2020	ADDRESS 1027 Cedar St	Square Feet 20883	BLDG NO 1467	(SNY) SNYAMNCUT FIFTH FLOOR	FLOOR 5
----------------------------	--------------------------	----------------------	-----------------	--------------------------------	------------

DRAWINGS ARE NOT TO SCALE



- FICM Code 210 Classroom
- FICM Code 110 Classroom

- = FIRE EXTINGUISHER
- = AED
- = FIRE DEP. CONNECTION
- = LOCK BOX
- = FIRE ALARM CONTROL PANEL
- = SPRINKLER HEADER
- R** = SPRINKLER RISER
- = Bottle Filler

DATE REVISED
11/30/2020

ADDRESS
1027 Cedar St

Square Feet
20694

BLDG NO
1467

(SNY) SNYAMNCUT
SIXTH FLOOR

FLOOR
6

DRAWINGS ARE NOT TO SCALE



MAIN FLOOR
SURPLUS SALES BUILDING

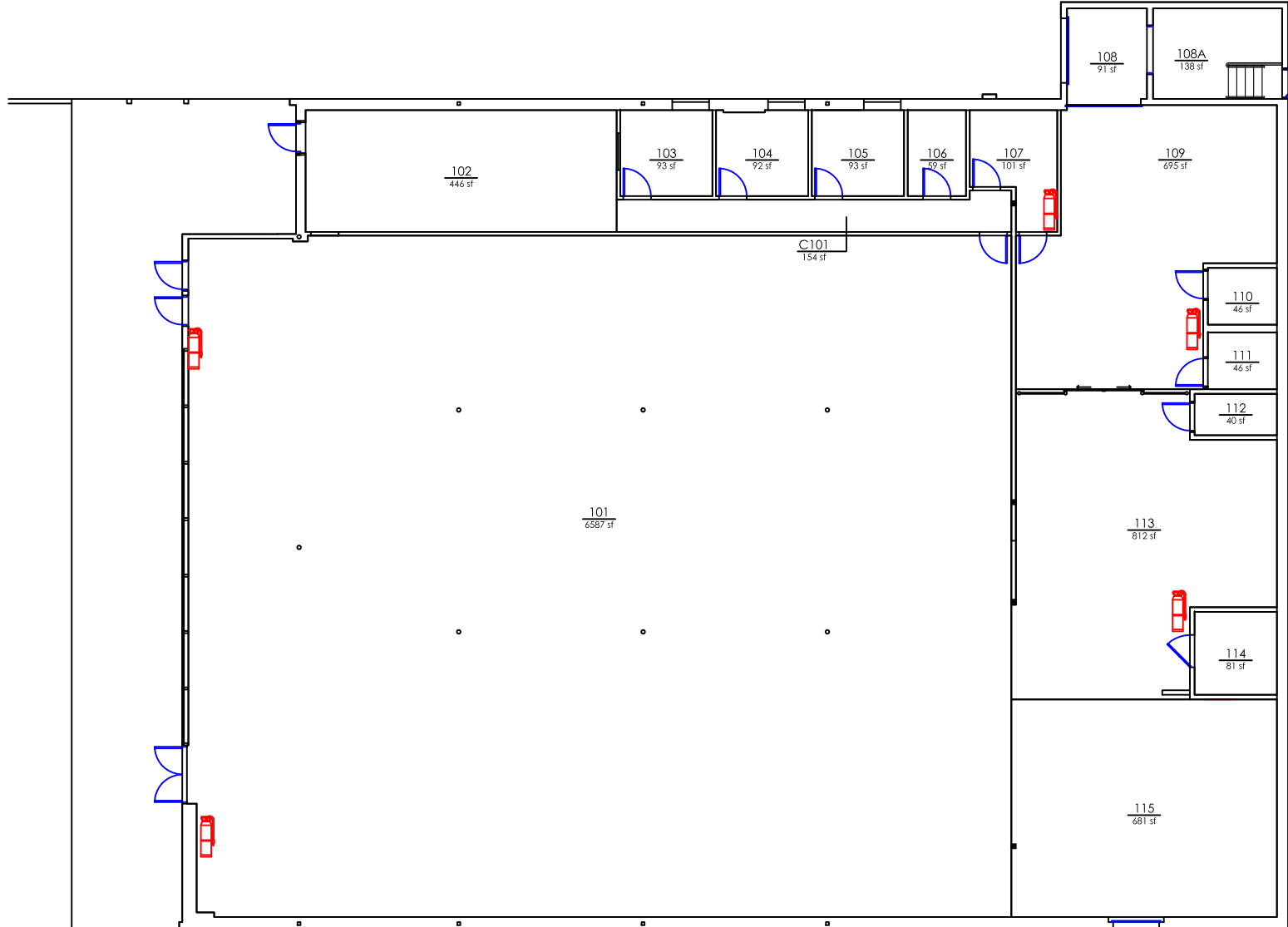

- FICM Code 210 Classroom
- FICM Code 110 Classroom

- = FIRE EXTINGUISHER
- = AED
- = FIRE DEP. CONNECTION
- = LOCK BOX
- = FIRE ALARM CONTROL PANEL
- = SPRINKLER HEADER
- R** = SPRINKLER RISER
- = Bottle Filler

DATE REVISED
12/05/2020

ADDRESS
215 2nd St

Square Feet
10880



BLDG NO
1610

(SSB) SURPLUS SALES BUILDING
FIRST FLOOR

FLOOR
01

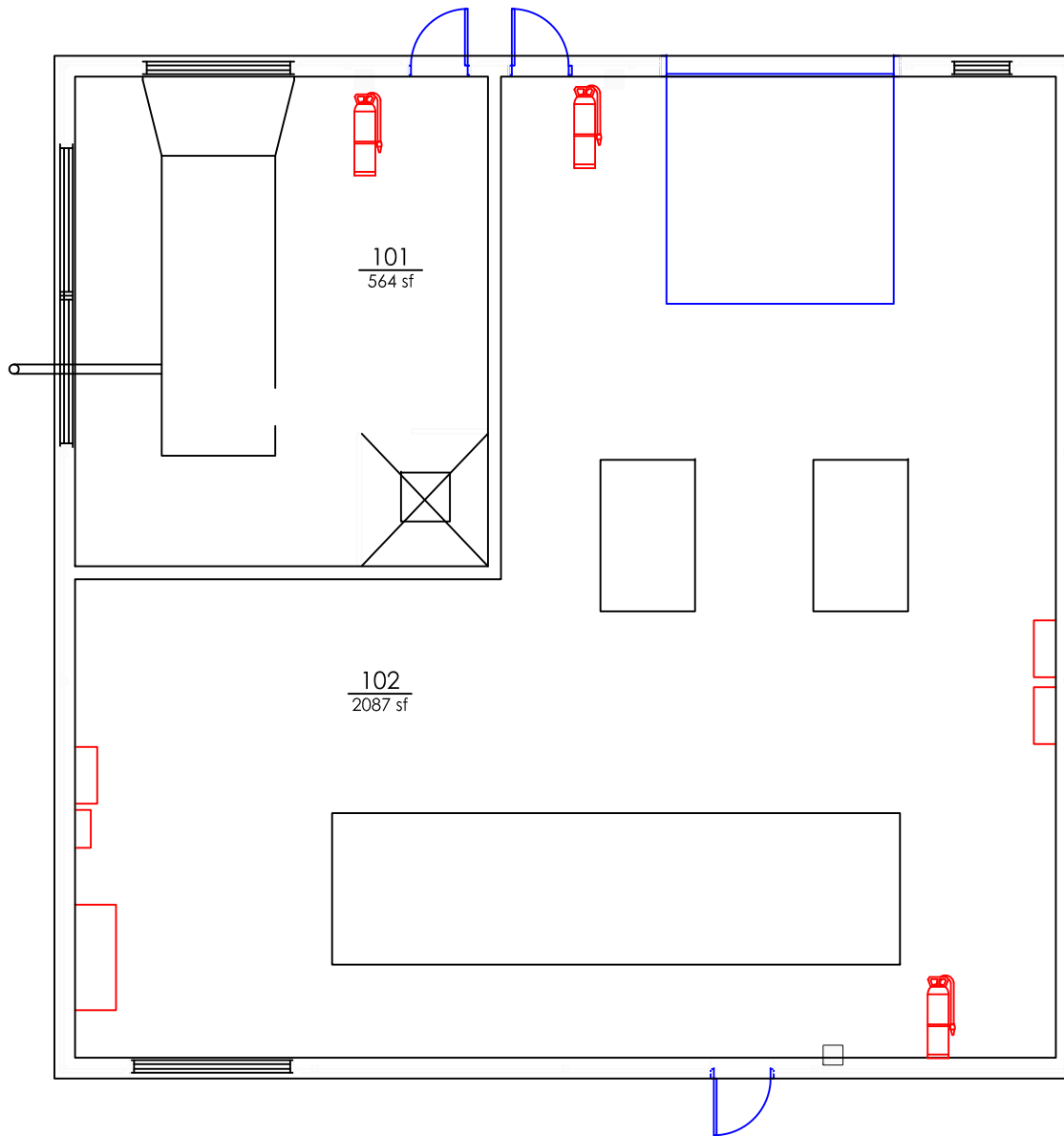
DRAWINGS ARE NOT TO SCALE



 FICM Code 210 Classroom
 FICM Code 110 Classroom

 = FIRE EXTINGUISHER
  = AED
  = FIRE DEP. CONNECTION
  = LOCK BOX
  = FIRE ALARM CONTROL PANEL
  = SPRINKLER HEADER
 R = SPRINKLER RISER
  = Bottle Filler

DATE REVISED
12/05/2020

ADDRESS
120 N. 11th St



Square Feet
2916

BLDG NO
1455

(SSO) SUB STATION
NO.1 FIRST FLOOR

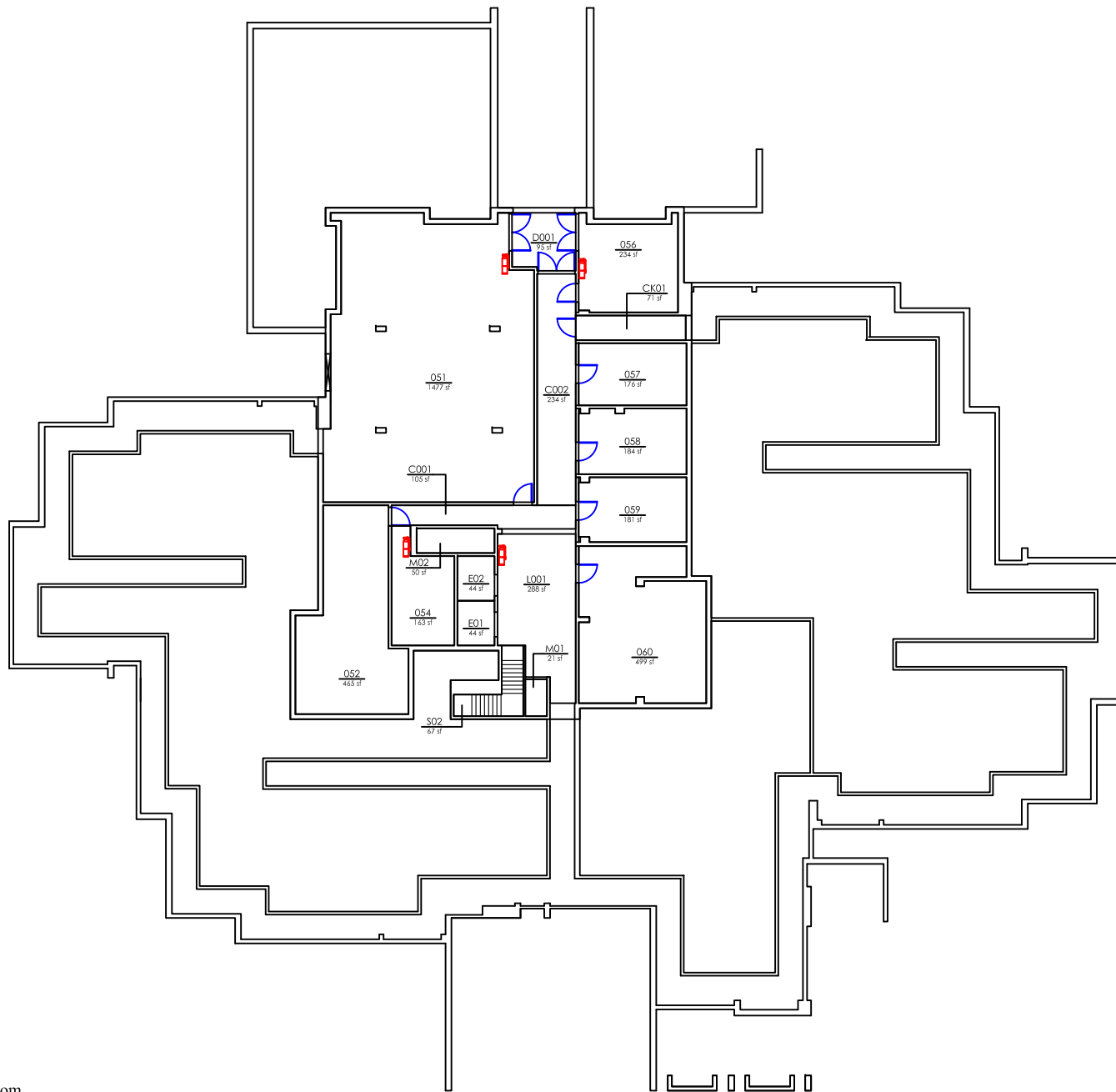
FLOOR
01



 FICM Code 210 Classroom
 FICM Code 110 Classroom

 = FIRE EXTINGUISHER  = AED  = FIRE DEP. CONNECTION  = LOCK BOX  = FIRE ALARM CONTROL PANEL  = SPRINKLER HEADER **R** = SPRINKLER RISER  = Bottle Filler

DATE REVISED
12/05/2020

ADDRESS
202 N 10th St

Square Feet
4923



BLDG NO
1465

(STR) STREETER
HALL BASEMENT

FLOOR
0

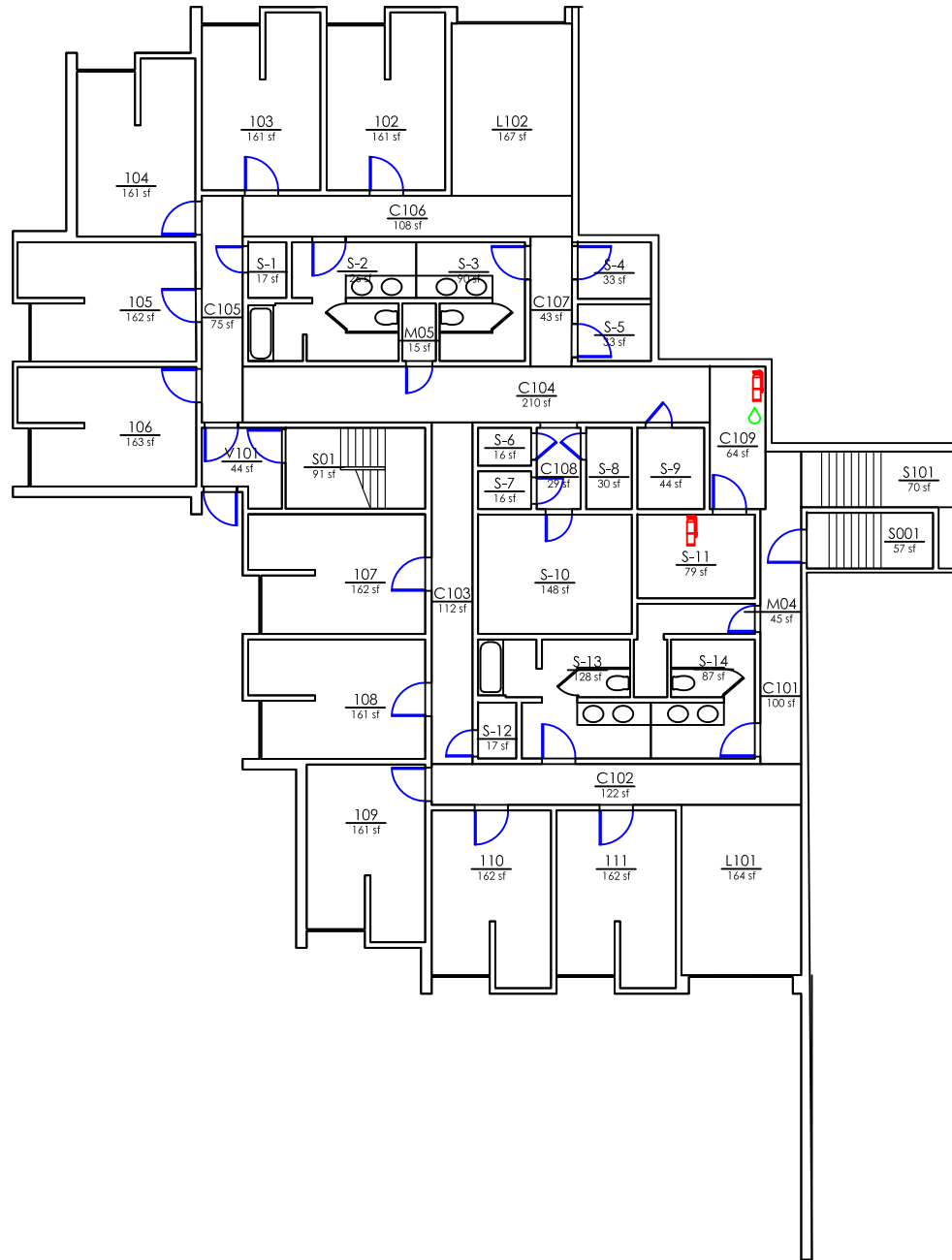
DRAWINGS ARE NOT TO SCALE





 FICM Code 210 Classroom
 FICM Code 110 Classroom

 = FIRE EXTINGUISHER  = AED  = FIRE DEP. CONNECTION  = LOCK BOX  = FIRE ALARM CONTROL PANEL  = SPRINKLER HEADER  = SPRINKLER RISER  = Bottle Filler

DATE REVISED 12/05/2020	ADDRESS 202 N 10th St	Square Feet 4601	BLDG NO 1465	(STR) STREETER HALL FIRST FLOOR	FLOOR 1
----------------------------	--------------------------	---------------------	-----------------	------------------------------------	------------

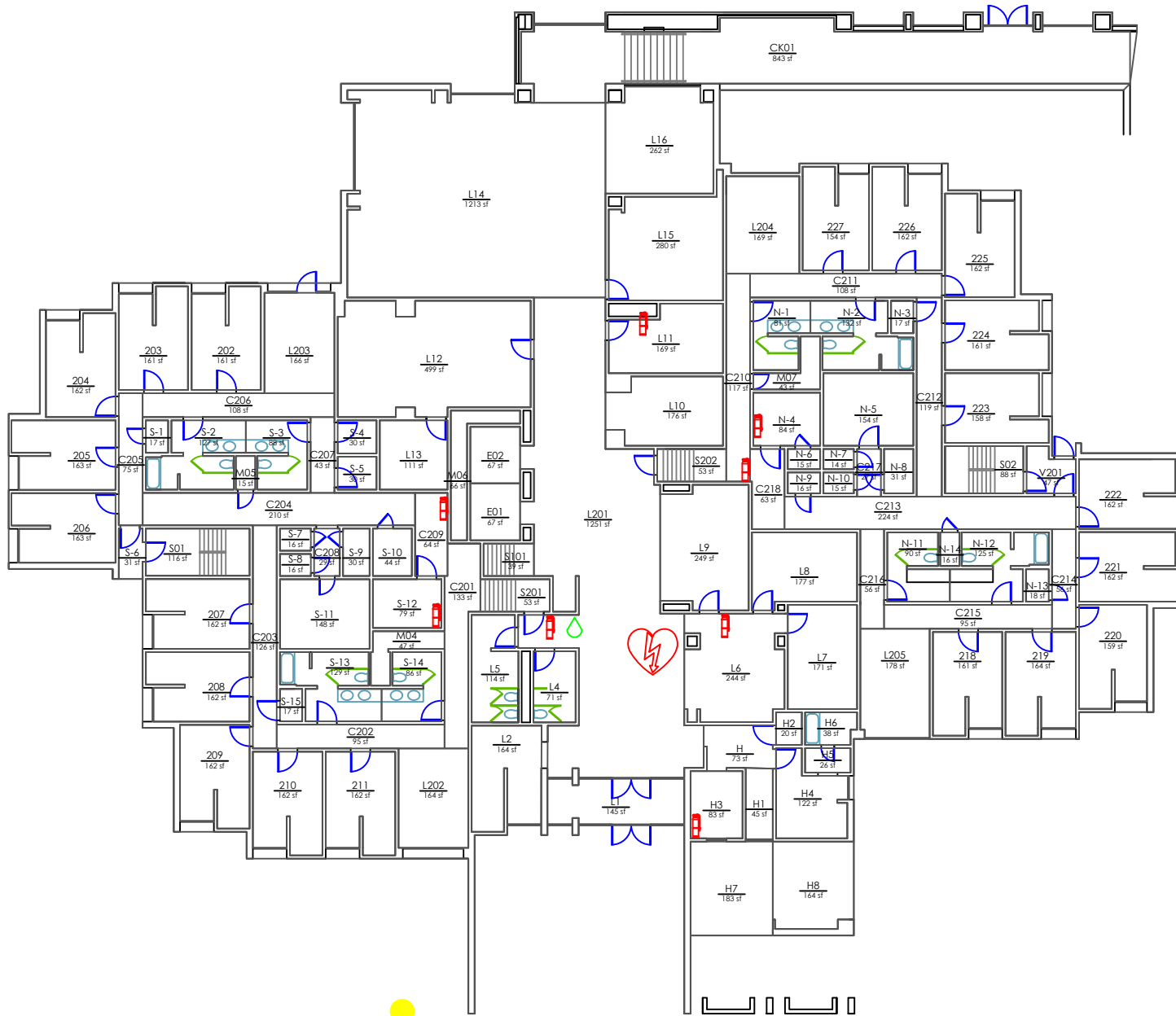
DRAWINGS ARE NOT TO SCALE





 FICM Code 210 Classroom
 FICM Code 110 Classroom

 = FIRE EXTINGUISHER  = AED  = FIRE DEP. CONNECTION  = LOCK BOX  = FIRE ALARM CONTROL PANEL  = SPRINKLER HEADER **R** = SPRINKLER RISER  = Bottle Filler

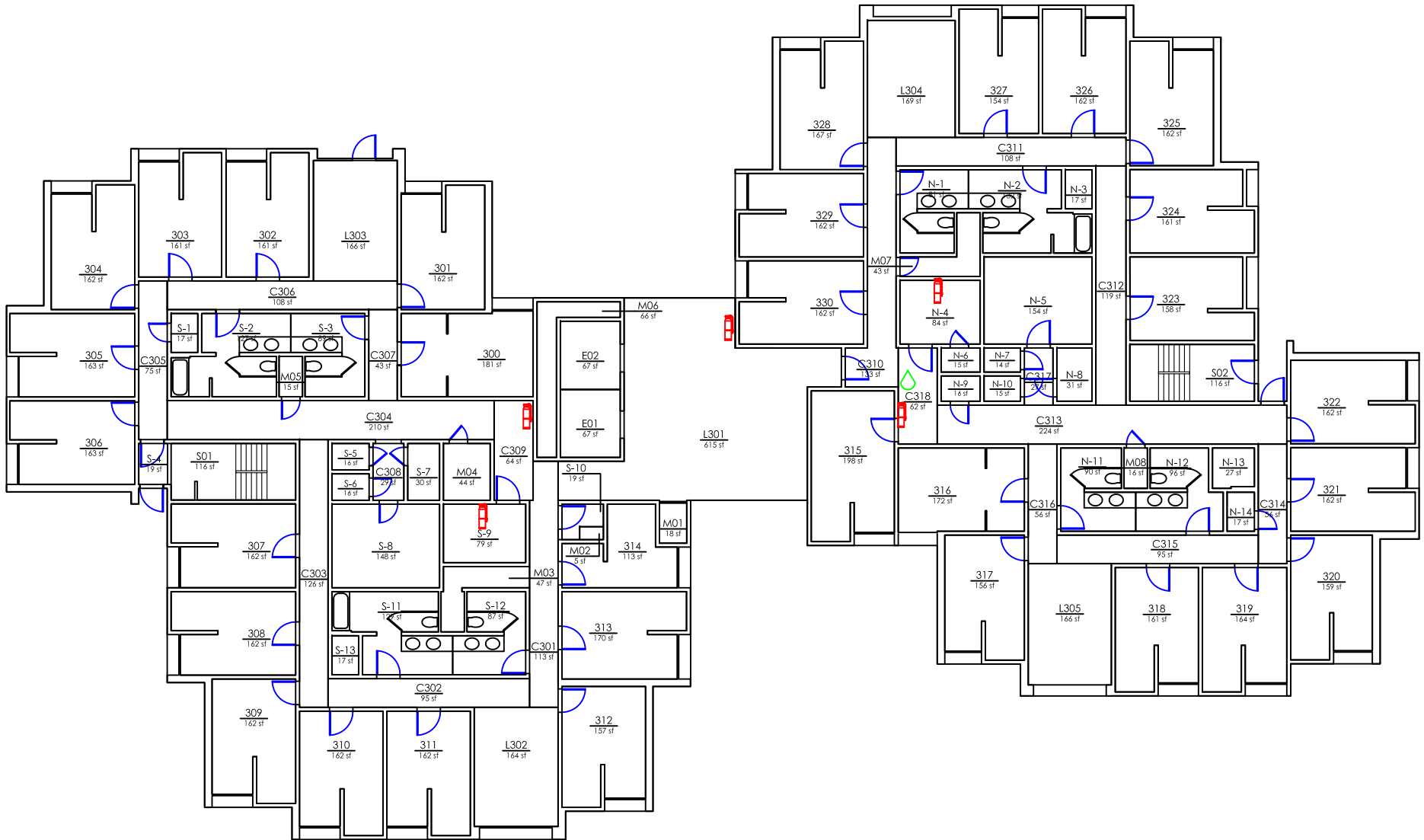
DATE REVISED 02/01/2022	ADDRESS 202 N 10th St	Square Feet 16962	BLDG NO 1465	(STR) STREETER HALL SECOND FLOOR	FLOOR 2
----------------------------	--------------------------	----------------------	-----------------	-------------------------------------	------------



 FICM Code 210 Classroom
 FICM Code 110 Classroom

 = FIRE EXTINGUISHER  = AED  = FIRE DEP. CONNECTION  = LOCK BOX  = FIRE ALARM CONTROL PANEL  = SPRINKLER HEADER **R** = SPRINKLER RISER  = Bottle Filler

DATE REVISED
12/05/2020

ADDRESS
202 N 10th St



Square Feet
11829

BLDG NO
1465

(STR) STREETER HALL
THIRD FLOOR

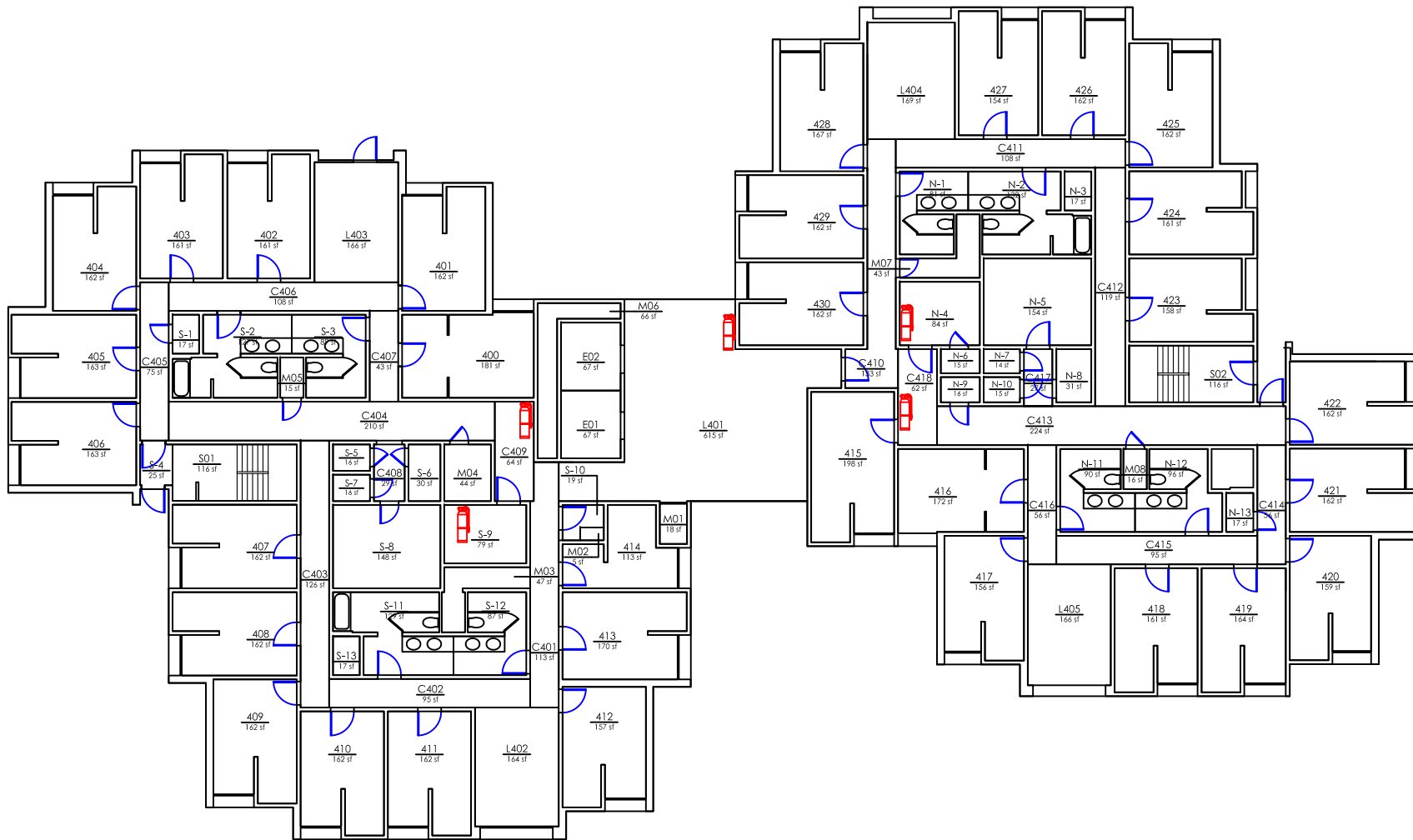
FLOOR
3



 FICM Code 210 Classroom
 FICM Code 110 Classroom

 = FIRE EXTINGUISHER  = AED  = FIRE DEP. CONNECTION  = LOCK BOX  = FIRE ALARM CONTROL PANEL  = SPRINKLER HEADER **R** = SPRINKLER RISER  = Bottle Filler

DATE REVISED
12/05/2020

ADDRESS
202 N 10th St



Square Feet
11829

BLDG NO
1465

(STR) STREETER HALL
FOURTH FLOOR

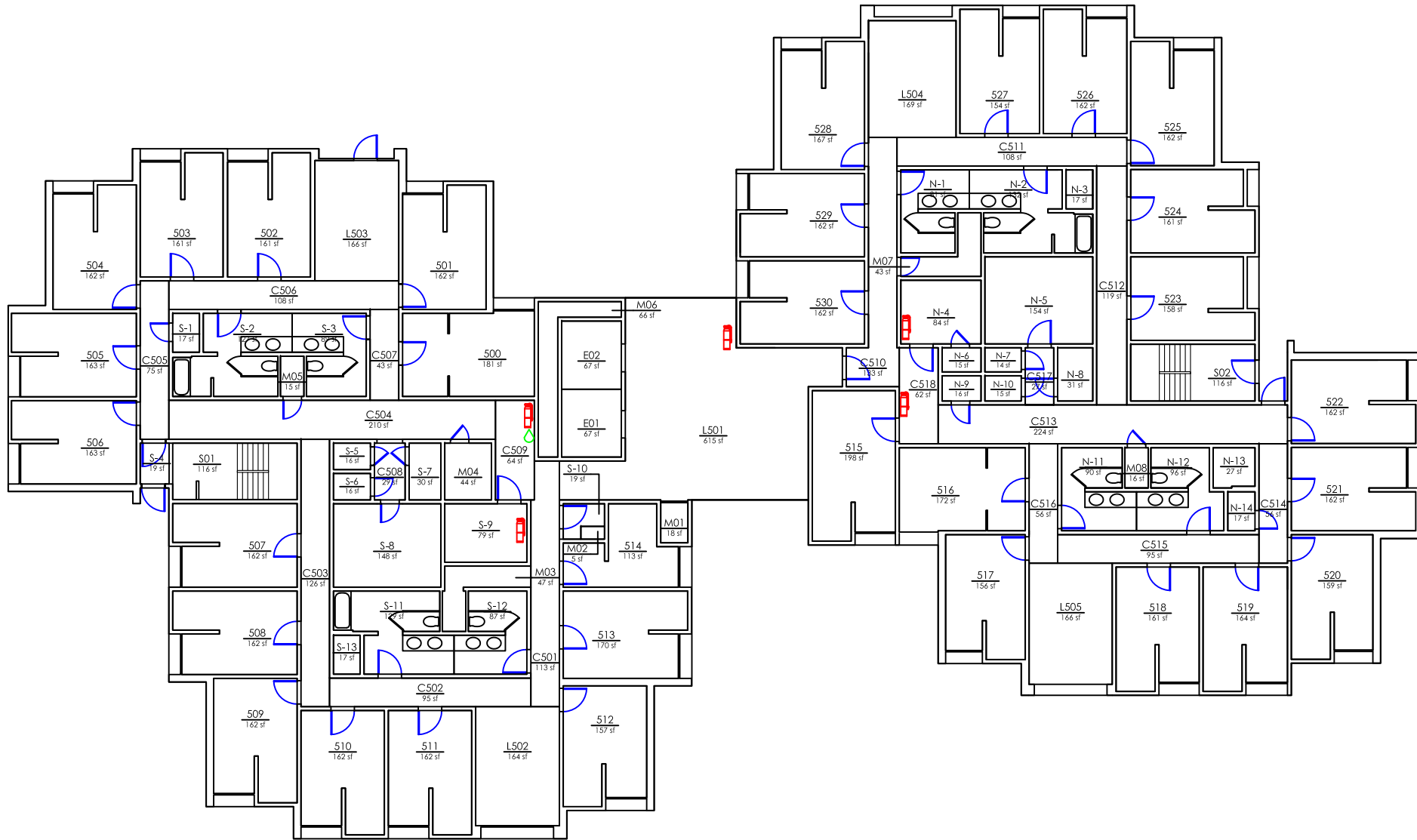
FLOOR
4



 FICM Code 210 Classroom
 FICM Code 110 Classroom

 = FIRE EXTINGUISHER  = AED  = FIRE DEP. CONNECTION  = LOCK BOX  = FIRE ALARM CONTROL PANEL  = SPRINKLER HEADER **R** = SPRINKLER RISER  = Bottle Filler

DATE REVISED
12/05/2020

ADDRESS
202 N 10th St



Square Feet
11829

BLDG NO
1465

(STR) STREETER HALL
FIFTH FLOOR

FLOOR
5



 FICM Code 210 Classroom
 FICM Code 110 Classroom

 = FIRE EXTINGUISHER  = AED  = FIRE DEP. CONNECTION  = LOCK BOX  = FIRE ALARM CONTROL PANEL  = SPRINKLER HEADER **R** = SPRINKLER RISER  = Bottle Filler

DATE REVISED
12/07/2020

ADDRESS
2020 N 10th St



Square Feet
11829

BLDG NO
1465

(STR) STREETER HALL
SIXTH FLOOR

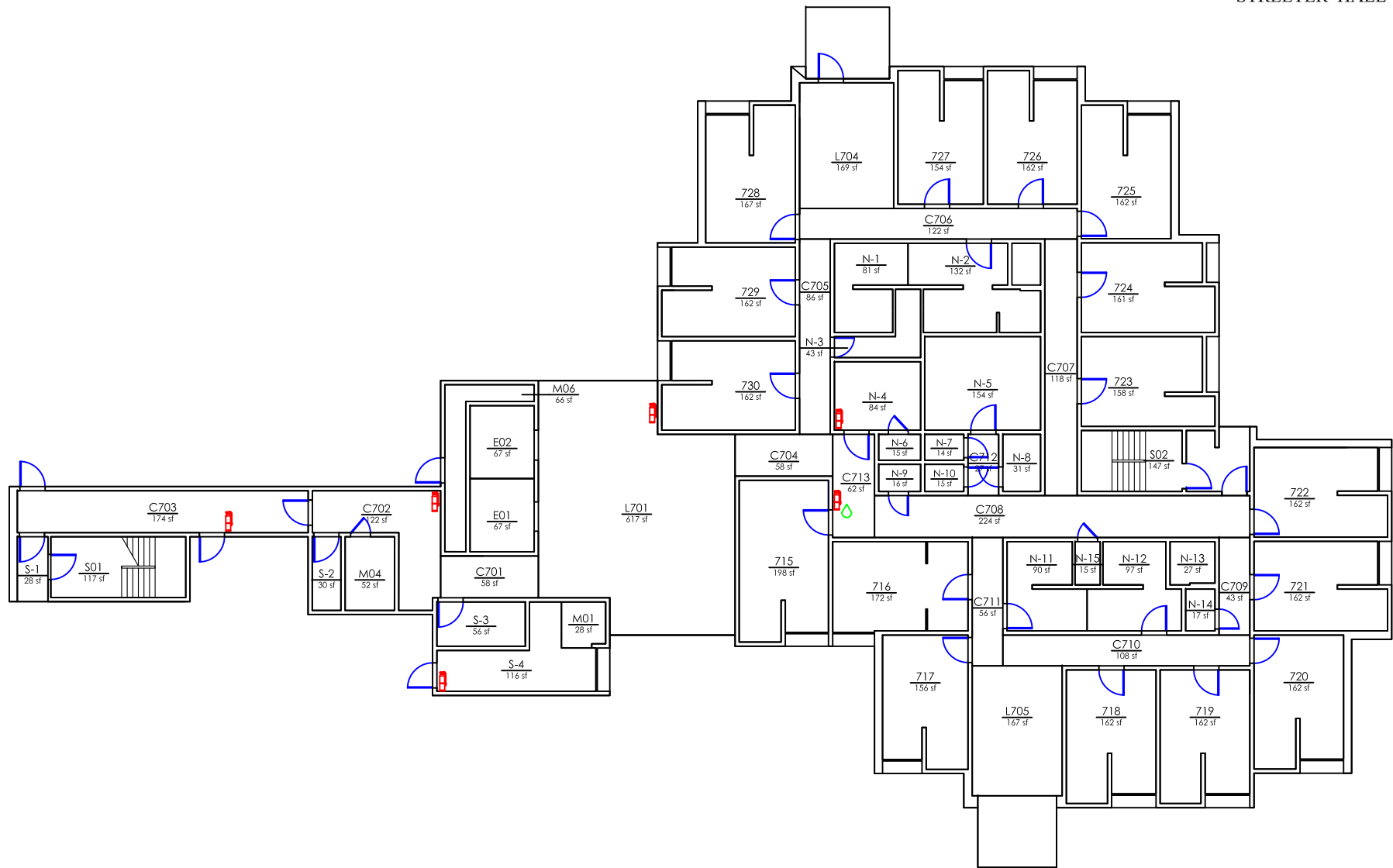
FLOOR
6





-  FICM Code 210 Classroom
-  FICM Code 110 Classroom

-  = FIRE EXTINGUISHER
-  = AED
-  = FIRE DEP. CONNECTION
-  = LOCK BOX
-  = FIRE ALARM CONTROL PANEL
-  = SPRINKLER HEADER
-  = SPRINKLER RISER
-  = Bottle Filler

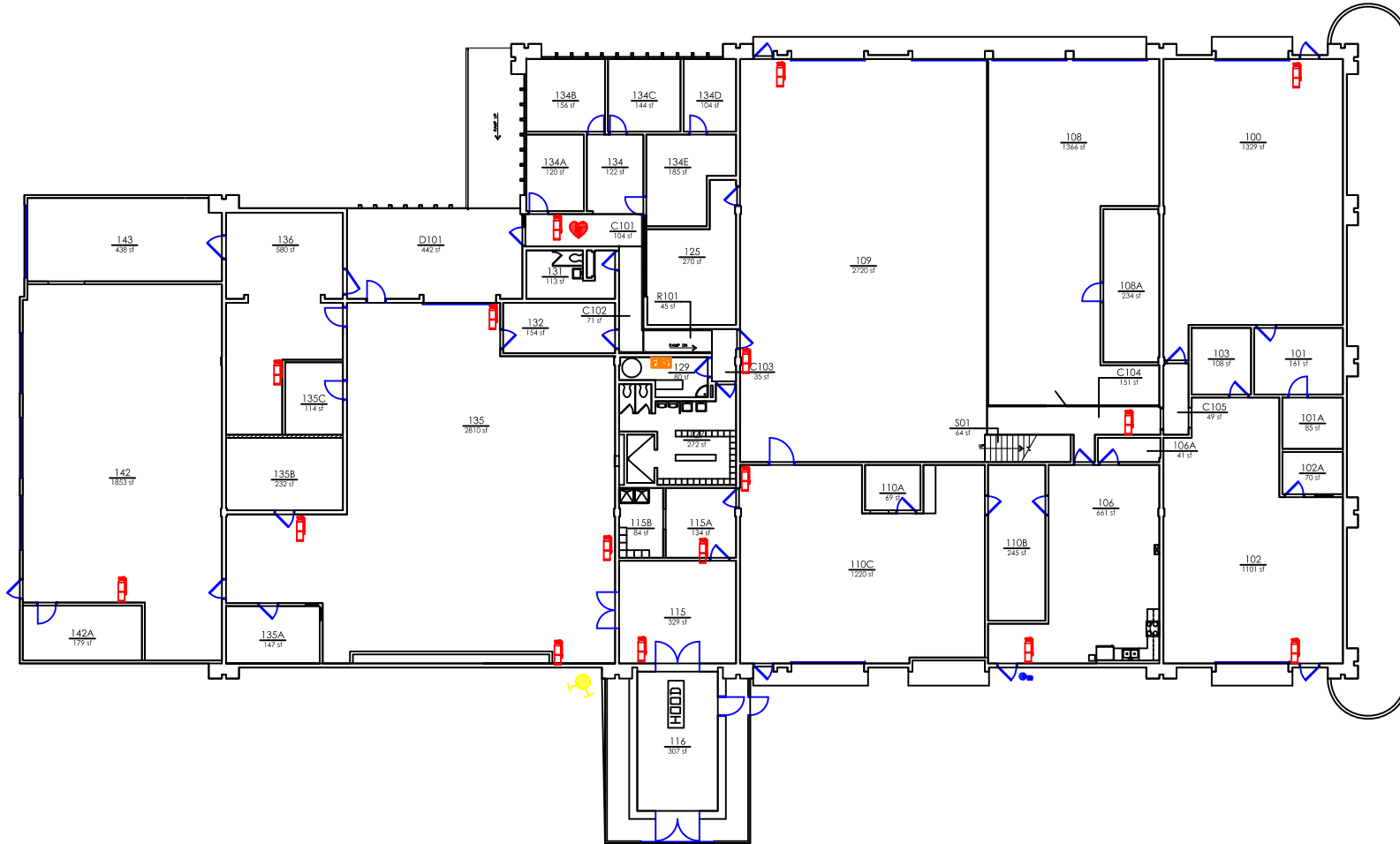
DATE REVISED	ADDRESS	Square Feet	BLDG NO	(STR) STREETER HALL SEVENTH FLOOR	FLOOR
12/07/2020	2020 N 10th St	7485	1465		7





-  FICM Code 210 Classroom
-  FICM Code 110 Classroom

-  = FIRE EXTINGUISHER
-  = AED
-  = FIRE DEP. CONNECTION
-  = LOCK BOX
-  = FIRE ALARM CONTROL PANEL
-  = SPRINKLER HEADER
-  = SPRINKLER RISER
-  = Bottle Filler

DATE REVISED 12/07/2020	ADDRESS 1510 Washington St	Square Feet 20896	BLDG NO 1450	(SUR) SURBECK MAINTENANCE BUILDING FIRST FLOOR	FLOOR 1
----------------------------	-------------------------------	----------------------	-----------------	---	------------

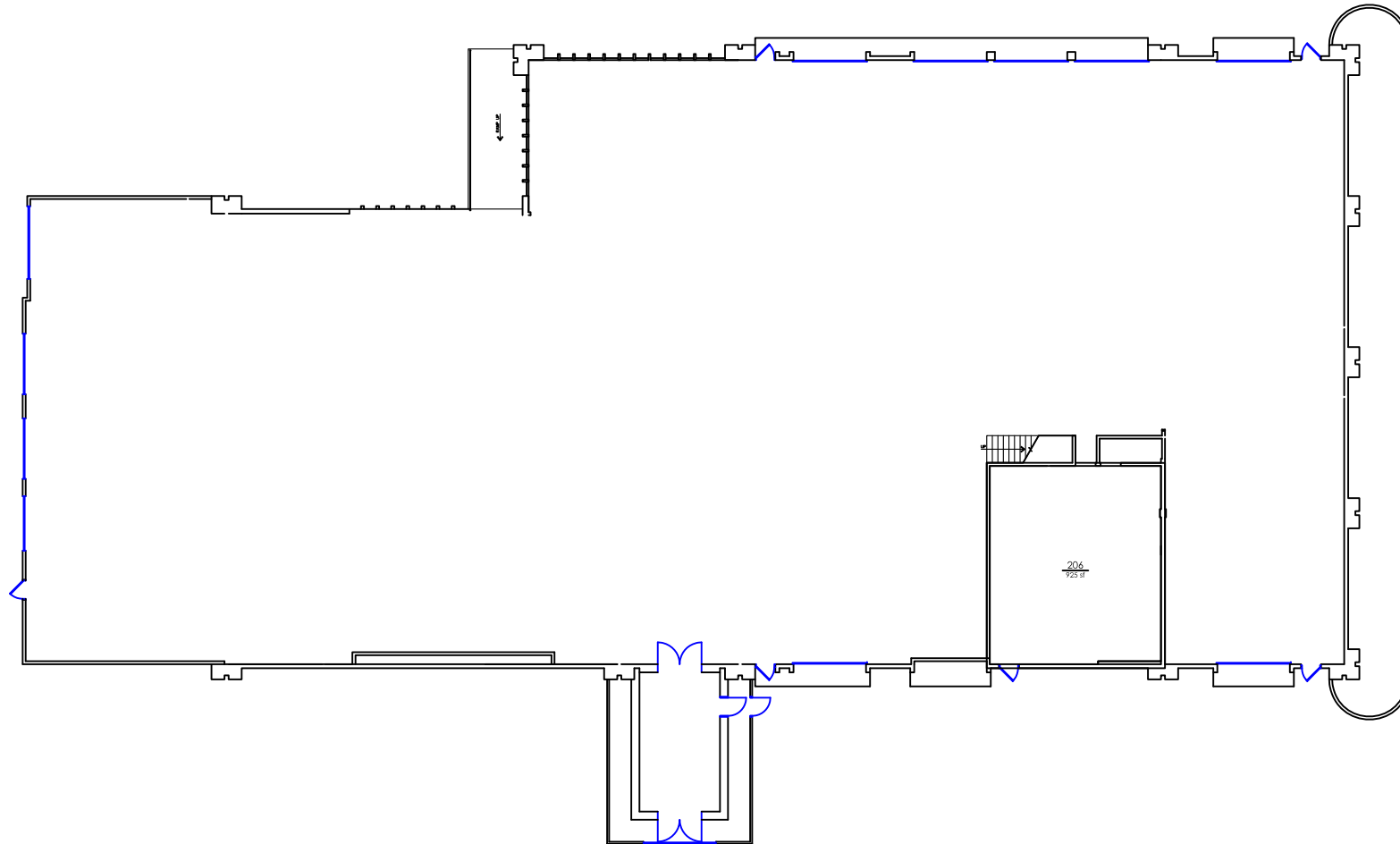
DRAWINGS ARE NOT TO SCALE



-  FICM Code 210 Classroom
-  FICM Code 110 Classroom

-  = FIRE EXTINGUISHER
-  = AED
-  = FIRE DEP. CONNECTION
-  = LOCK BOX
-  = FIRE ALARM CONTROL PANEL
-  = SPRINKLER HEADER
-  = SPRINKLER RISER
-  = Bottle Filler



DATE REVISED 12/07/2020	ADDRESS 1510 Washington St	Square Feet 1036	BLDG NO 1450	(SUR) SURBECK MAINTENANCE BUILDING SECOND FLOOR	FLOOR 2
----------------------------	-------------------------------	---------------------	-----------------	--	------------

DRAWINGS ARE NOT TO SCALE

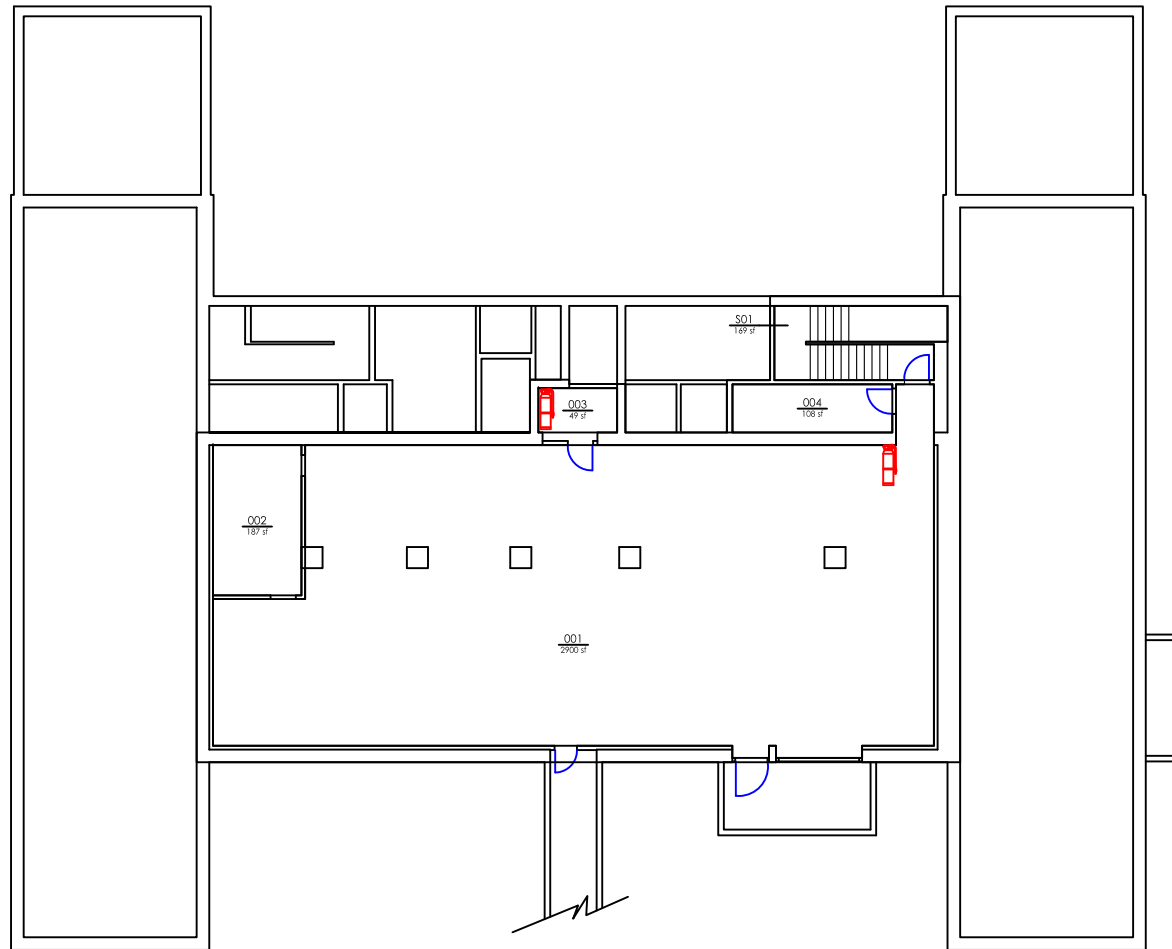

BASEMENT
SUTTON HALL



 FICM Code 210 Classroom
 FICM Code 110 Classroom

 = FIRE EXTINGUISHER  = AED  = FIRE DEP. CONNECTION  = LOCK BOX  = FIRE ALARM CONTROL PANEL  = SPRINKLER HEADER **R** = SPRINKLER RISER  = Bottle Filler

DATE REVISED
12/14/2020

ADDRESS
333 Eagle LN

Square Feet
4001

BLDG NO
1112

(SUT) SUTTON
HALL BASEMENT

FLOOR
0

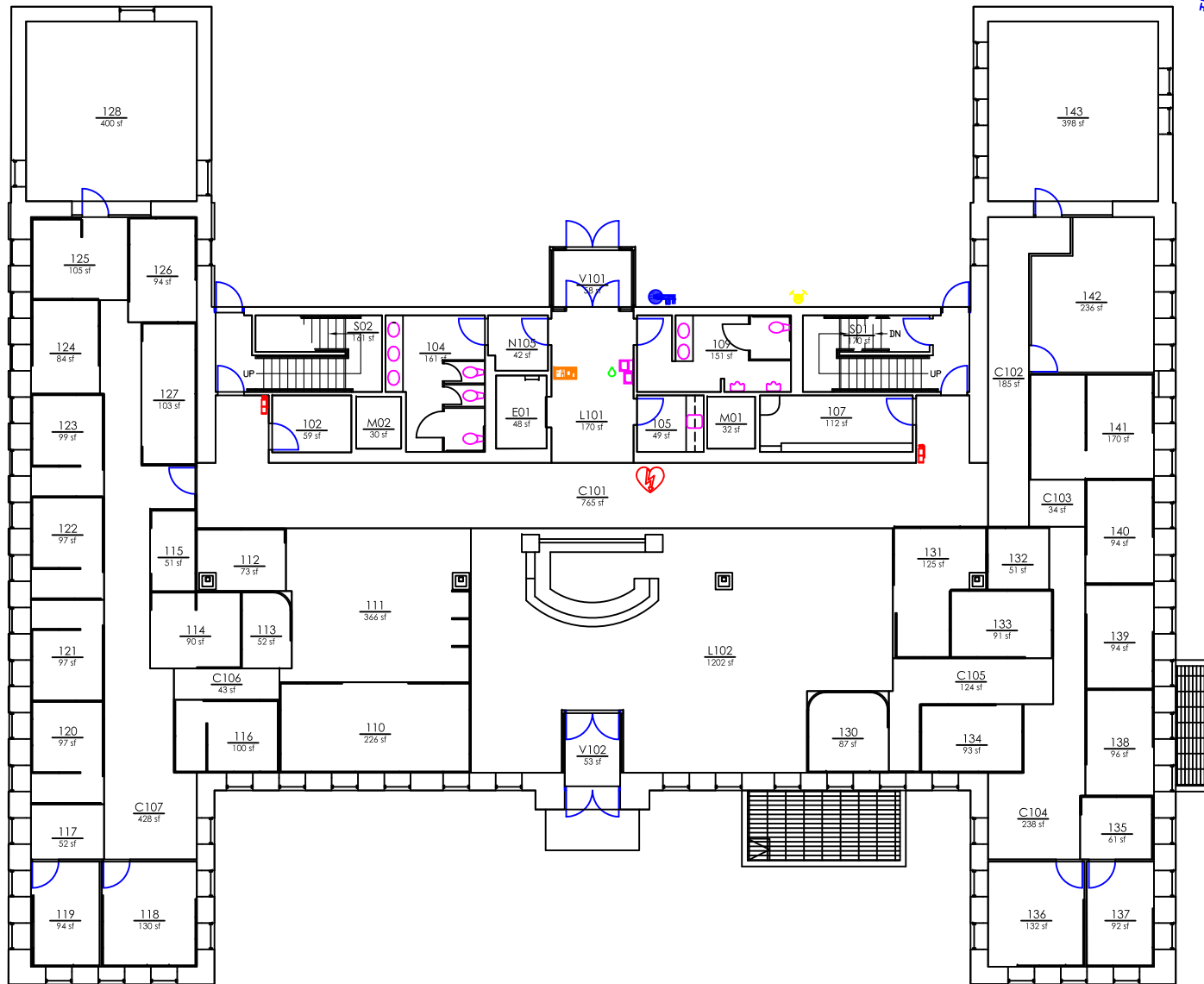

FICM Code 210 Classroom
 FICM Code 110 Classroom

= FIRE EXTINGUISHER = AED = FIRE DEP. CONNECTION = LOCK BOX = FIRE ALARM CONTROL PANEL = SPRINKLER HEADER = SPRINKLER RISER = Bottle Filler

DATE REVISED
12/14/2020

ADDRESS
333 Eagle LN



Square Feet
10041

BLDG NO
1112

(SUT) SUTTON HALL
FIRST FLOOR

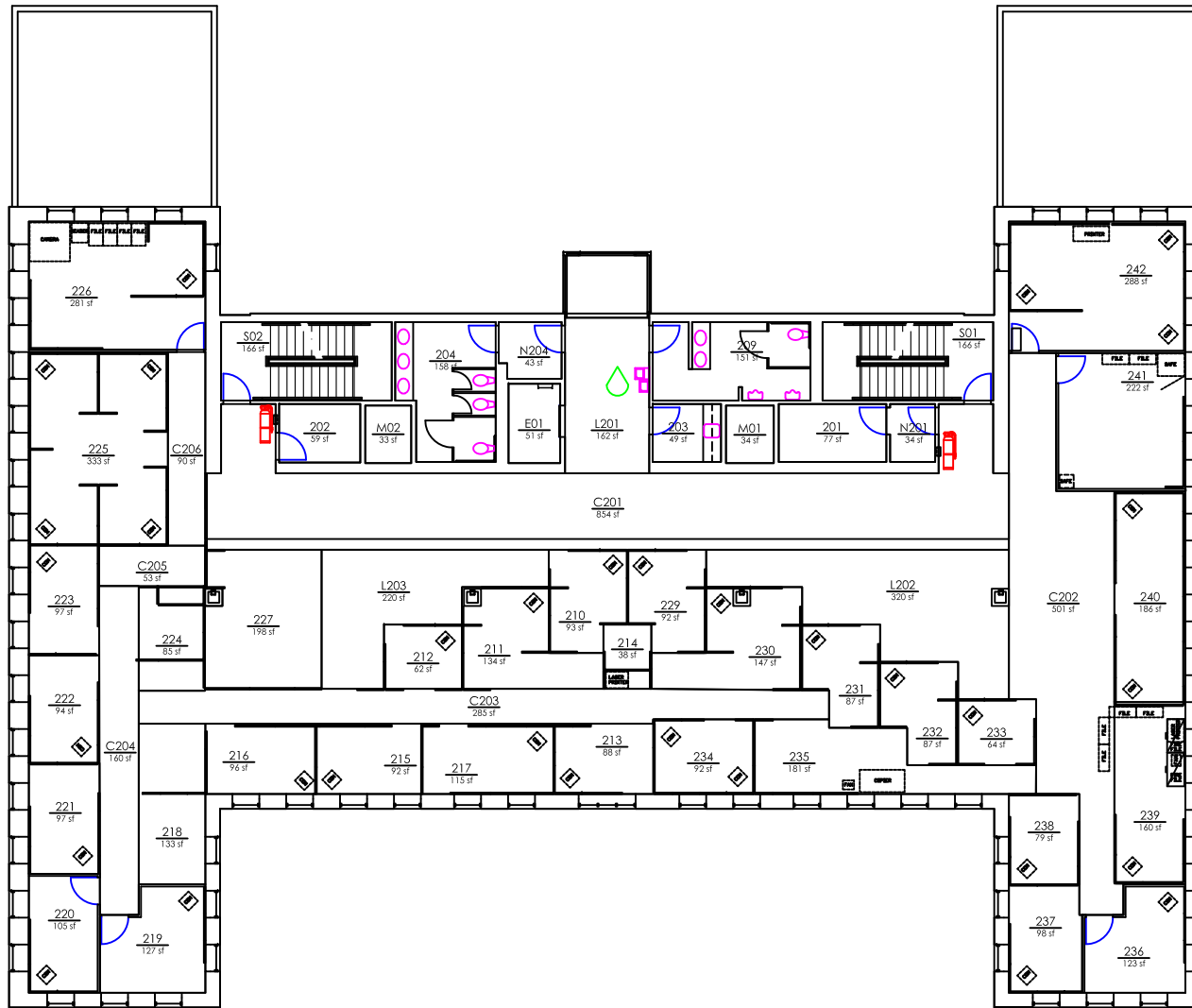
FLOOR
1



 FICM Code 210 Classroom
 FICM Code 110 Classroom

 = FIRE EXTINGUISHER  = AED  = FIRE DEP. CONNECTION  = LOCK BOX  = FIRE ALARM CONTROL PANEL  = SPRINKLER HEADER **R** = SPRINKLER RISER  = Bottle Filler

DATE REVISED
12/14/2020

ADDRESS
333 Eagle LN

Square Feet
8949

BLDG NO
1112

(SUT) SUTTON HALL
SECOND FLOOR

FLOOR
2

DRAWINGS ARE NOT TO SCALE

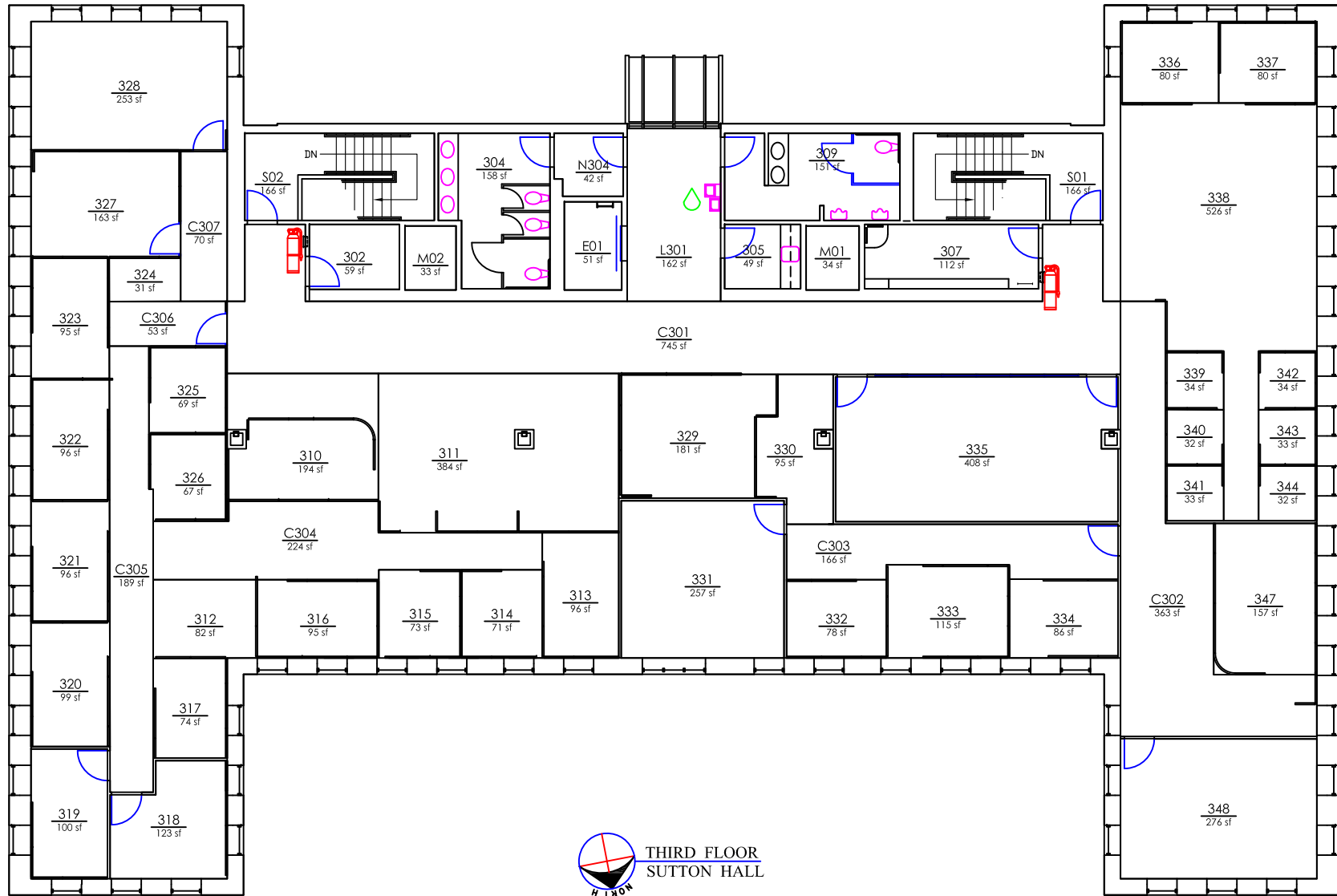

- FICM Code 210 Classroom
- FICM Code 110 Classroom

- = FIRE EXTINGUISHER
- = AED
- = FIRE DEP. CONNECTION
- = LOCK BOX
- = FIRE ALARM CONTROL PANEL
- = SPRINKLER HEADER
- = SPRINKLER RISER
- = Bottle Filler

DATE REVISED 12/15/2020	ADDRESS 333 Eagles LN	Square Feet 8936	BLDG NO 1112	(SUT) SUTTON HALL THIRD FLOOR	FLOOR 3
----------------------------	--------------------------	---------------------	-----------------	----------------------------------	------------

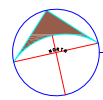
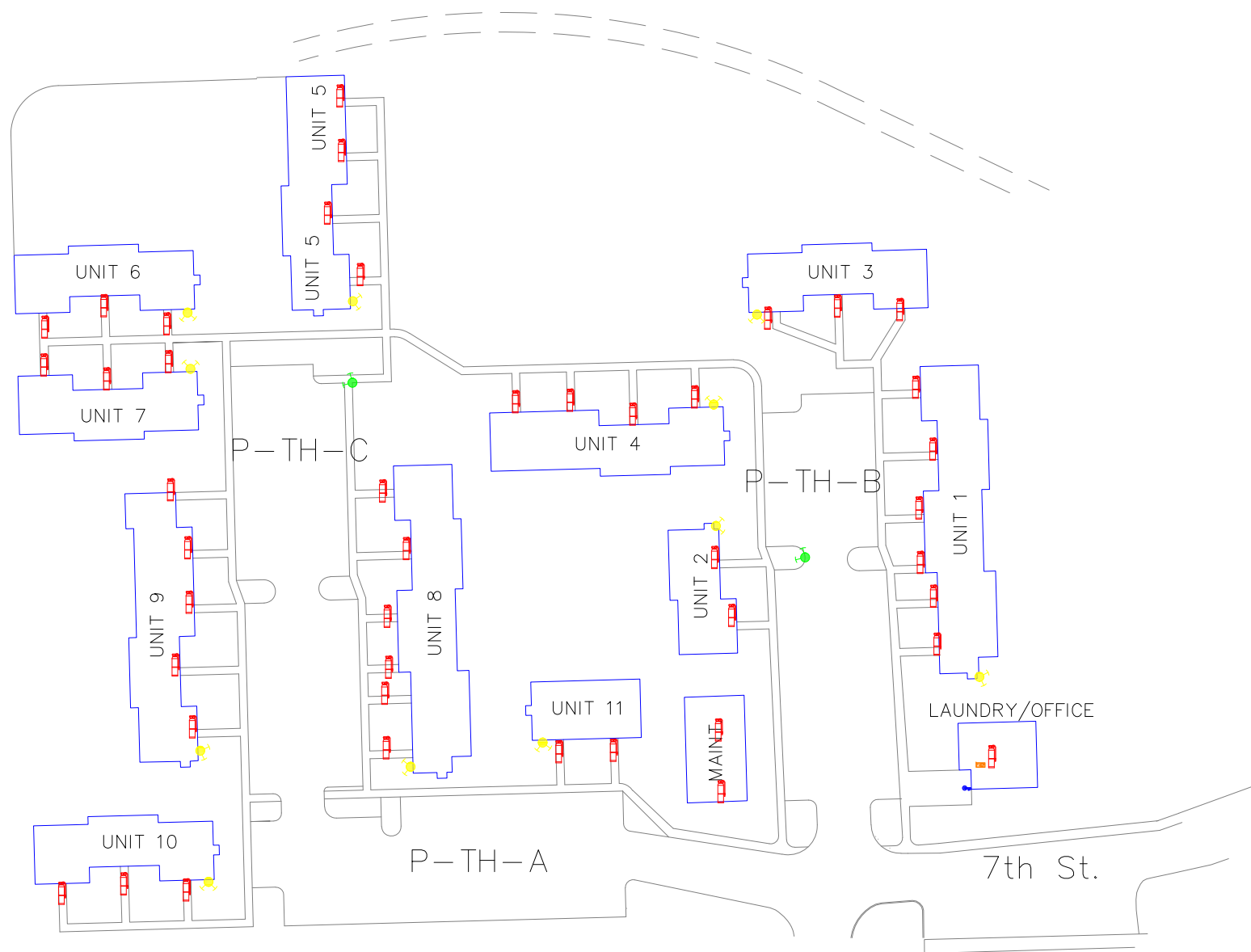

Townhouse Apartments

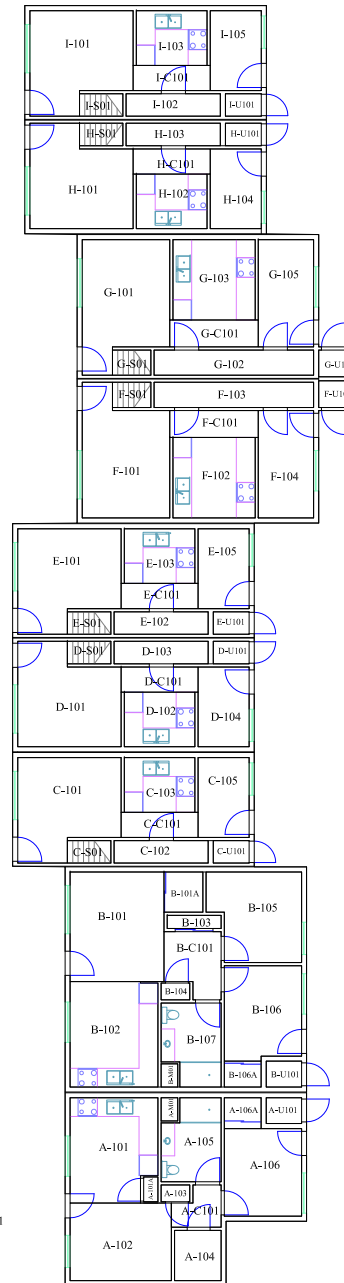

 NORTH
FIRST FLOOR
TOWNHOUSE APTS. BUILDING 1

 = FIRE EXTINGUISHER
  = AED
  = FIRE DEP. CONNECTION
  = LOCK BOX
  = FIRE ALARM CONTROL PANEL
  = SPRINKLER HEADER
  = SPRINKLER RISER

DATE CREATED
03-04-19

ADDRESS
620 W. 7TH
STREET

Square Feet
4728

AiM ID
1231

**(T01) TOWNHOUSE APARTMENT
BLDG 1**

FLOOR
1

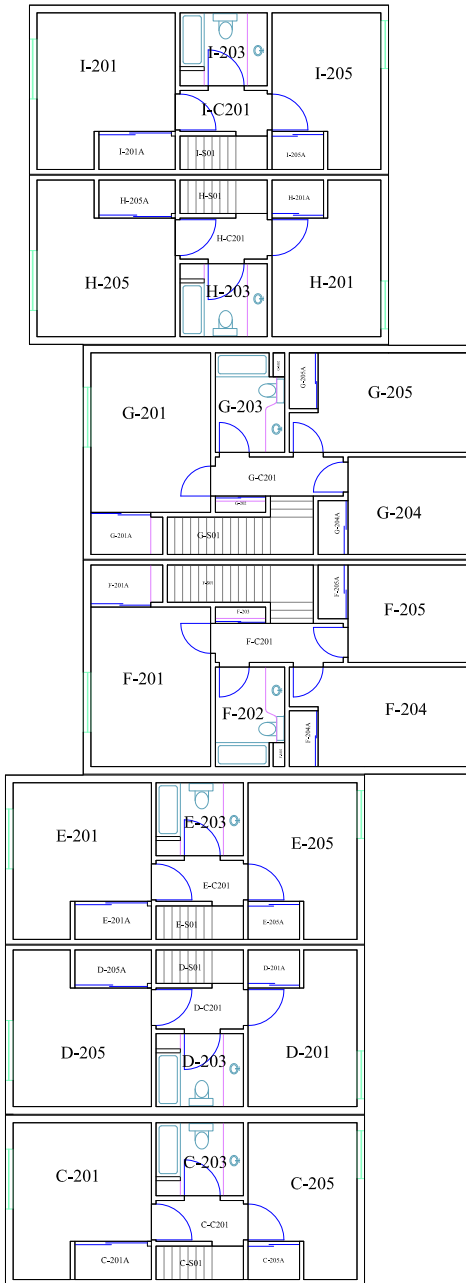

 NORTH
SECOND FLOOR
TOWNHOUSE APTS. BUILDING 1

 = FIRE EXTINGUISHER
  = AED
  = FIRE DEP. CONNECTION
  = LOCK BOX
  = FIRE ALARM CONTROL PANEL
  = SPRINKLER HEADER
  = SPRINKLER RISER

DATE CREATED
03-04-19

ADDRESS
620 W. 7TH
STREET

Square Feet
3305

AiM ID
1231

(T01)TOWNHOUSE APARTMENT
BLDG 1

FLOOR
2

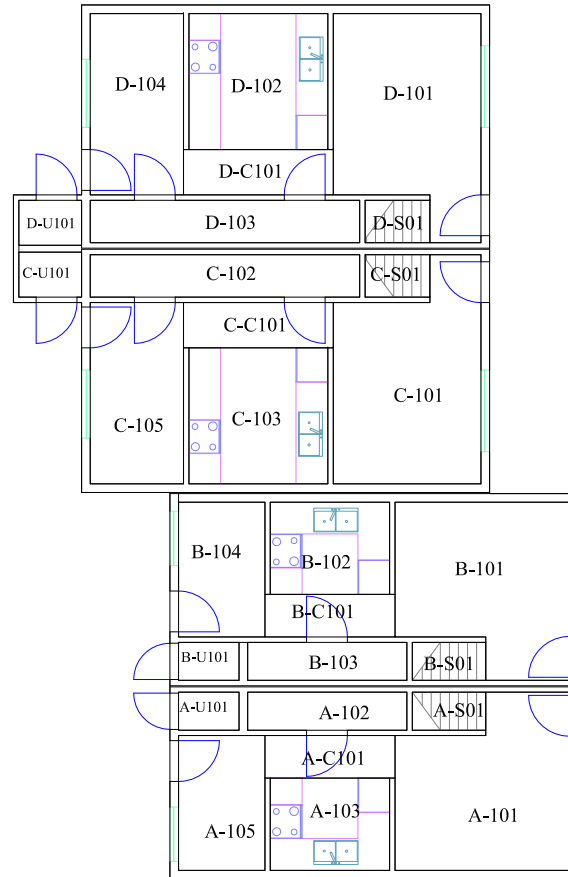

 = FIRE EXTINGUISHER
  = AED
  = FIRE DEP. CONNECTION
  = LOCK BOX
  = FIRE ALARM CONTROL PANEL
  = SPRINKLER HEADER
 R = SPRINKLER RISER

DATE CREATED 03-04-19	ADDRESS 620 W. 7TH STREET	Square Feet 1967	AiM ID 1232	(T02) TOWNHOUSE APARTMENT BLDG 2	FLOOR 1
---------------------------------	------------------------------	---------------------	----------------	---	-------------------

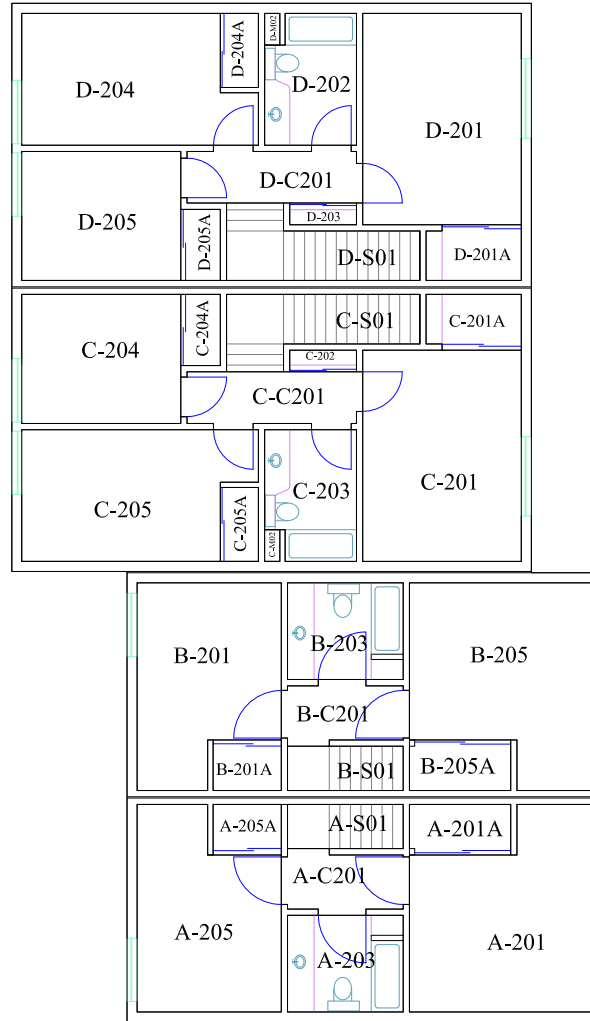

 NORTH
 SECOND FLOOR
 TOWNHOUSE APTS. BUILDING 2

 = FIRE EXTINGUISHER
  = AED
  = FIRE DEP. CONNECTION
  = LOCK BOX
  = FIRE ALARM CONTROL PANEL
  = SPRINKLER HEADER
 R = SPRINKLER RISER

DATE CREATED
03-04-19

ADDRESS
 620 W. 7TH
 STREET

Square Feet
2026

AiM ID
1232

**(T02) TOWNHOUSE APARTMENT
 BLDG 2**

FLOOR
2

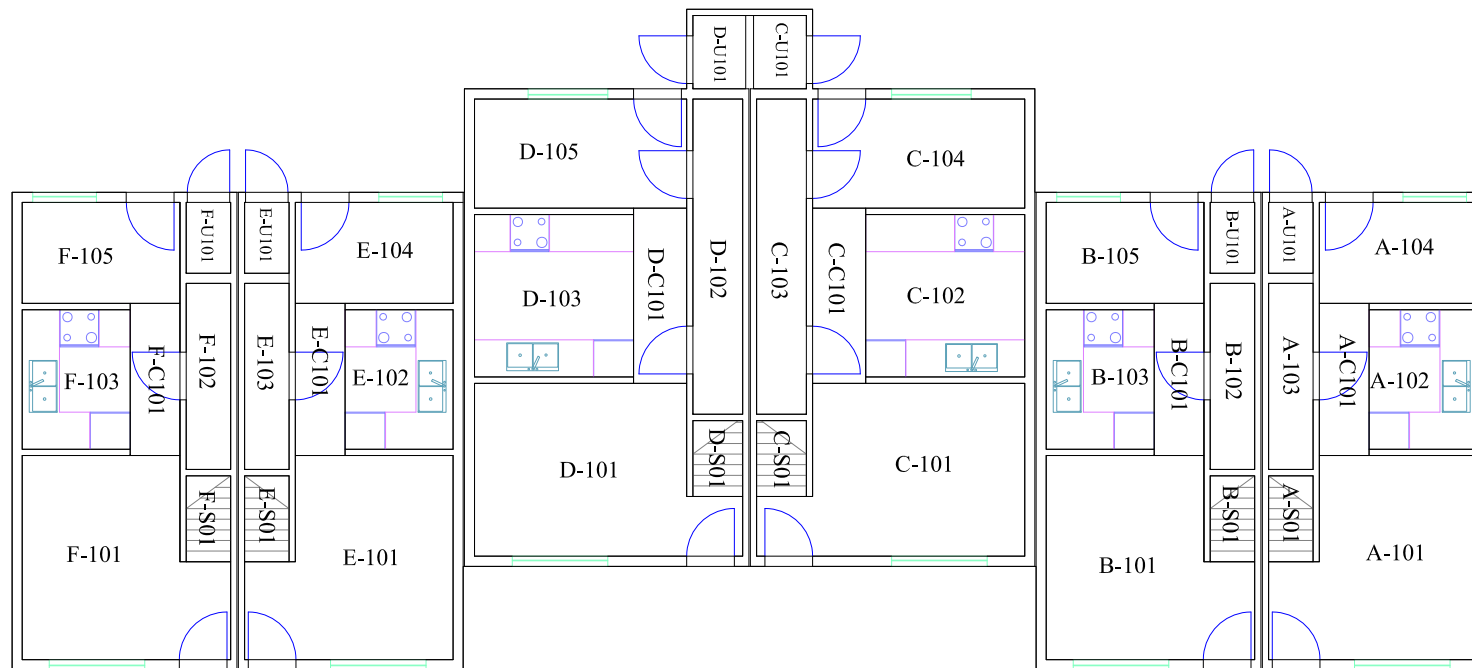

FIRST FLOOR
TOWNHOUSE APTS. BUILDING 3

 = FIRE EXTINGUISHER
  = AED
  = FIRE DEP. CONNECTION
  = LOCK BOX
  = FIRE ALARM CONTROL PANEL
  = SPRINKLER HEADER
  = SPRINKLER RISER

DATE CREATED
03-04-19

ADDRESS
620 W. 7TH
STREET

Square Feet
2819

AiM ID
1233

**(T03) TOWNHOUSE APARTMENT
BLDG 3**

FLOOR
1

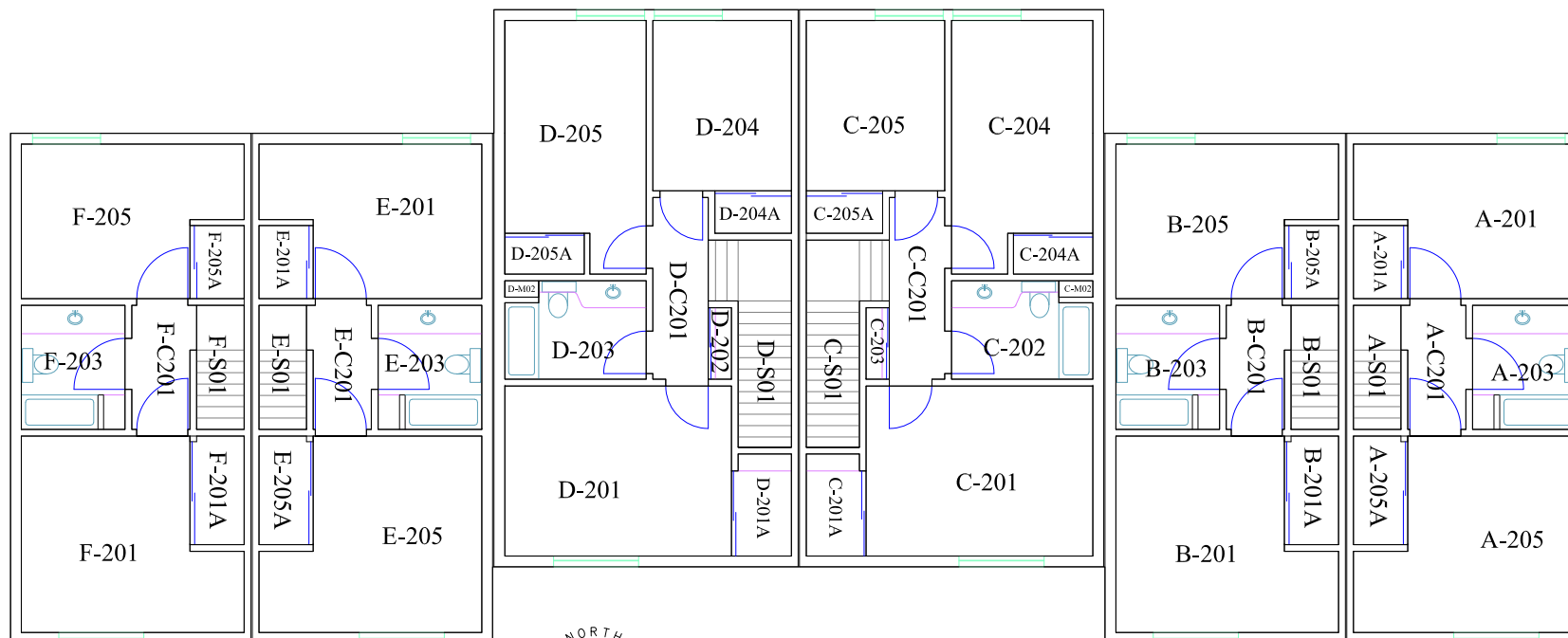

SECOND FLOOR
TOWNHOUSE APTS. BUILDING 3

 = FIRE EXTINGUISHER
  = AED
  = FIRE DEP. CONNECTION
  = LOCK BOX
  = FIRE ALARM CONTROL PANEL
  = SPRINKLER HEADER
  = SPRINKLER RISER

DATE CREATED
03-04-19

ADDRESS
620 W. 7TH
STREET

Square Feet
2879

AiM ID
1233

**(T03) TOWNHOUSE APARTMENT
BLDG 3**

FLOOR
2

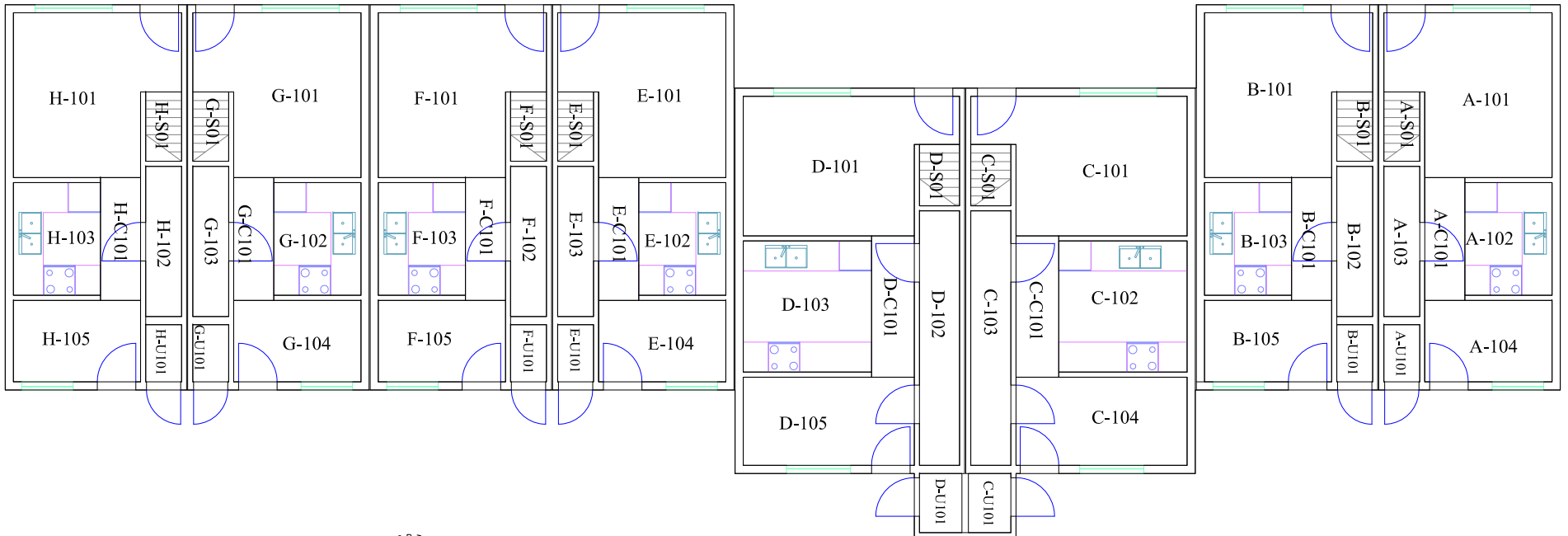

FIRST FLOOR
TOWNHOUSE APTS. BUILDING 4

 = FIRE EXTINGUISHER
  = AED
  = FIRE DEP. CONNECTION
  = LOCK BOX
  = FIRE ALARM CONTROL PANEL
  = SPRINKLER HEADER
  = SPRINKLER RISER

DATE CREATED
03-04-19

ADDRESS
620 W. 7TH STREET

Square Feet
3671

AiM ID
1234

**(T04) TOWNHOUSE APARTMENT
BLDG 4**

FLOOR
1

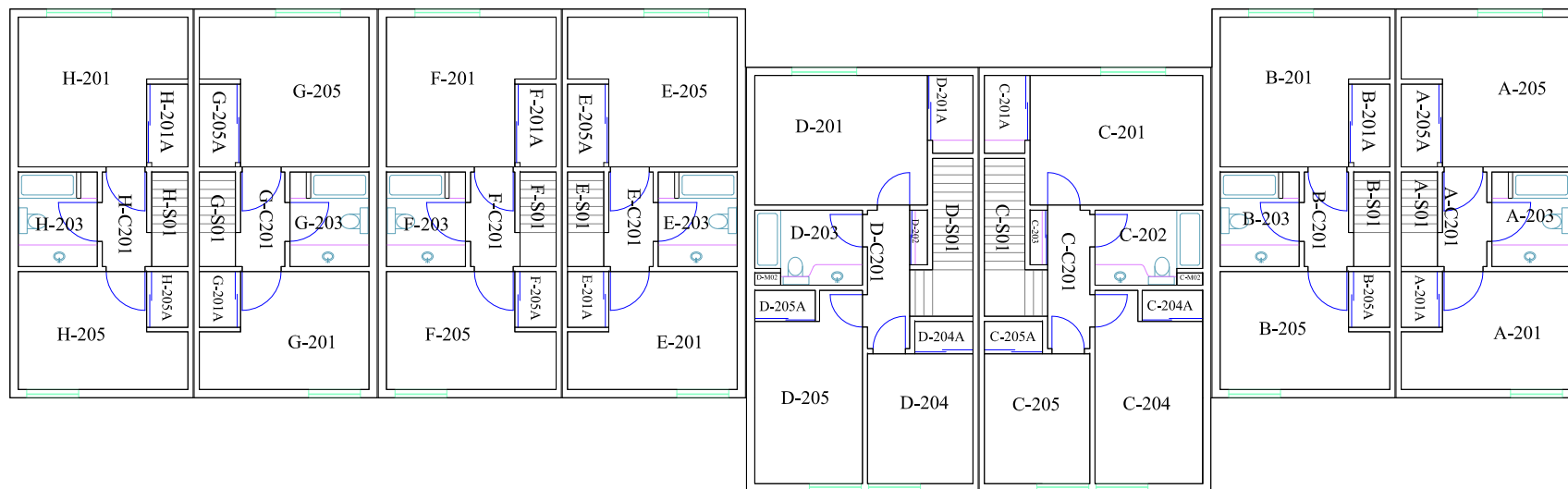

 NORTH
SECOND FLOOR
TOWNHOUSE APTS. BUILDING 4

 = FIRE EXTINGUISHER
  = AED
  = FIRE DEP. CONNECTION
  = LOCK BOX
  = FIRE ALARM CONTROL PANEL
  = SPRINKLER HEADER
 R = SPRINKLER RISER

DATE CREATED
03-04-19

ADDRESS
620 W. 7TH STREET

Square Feet
3731

AiM ID
1234

**(T04) TOWNHOUSE APARTMENT
BLDG 4**

FLOOR
2

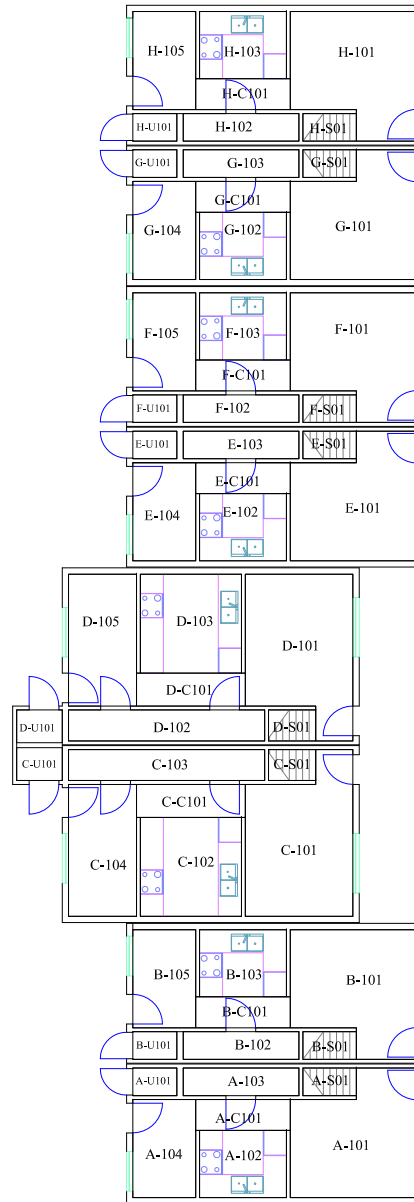

 = FIRE EXTINGUISHER
  = AED
  = FIRE DEP. CONNECTION
  = LOCK BOX
  = FIRE ALARM CONTROL PANEL
  = SPRINKLER HEADER
  = SPRINKLER RISER

DATE CREATED
03-04-19

ADDRESS
620 W. 7TH
STREET

Square Feet
3668

AiM ID
1235

(T05) TOWNHOUSE APARTMENT
BLDG 5

FLOOR
1

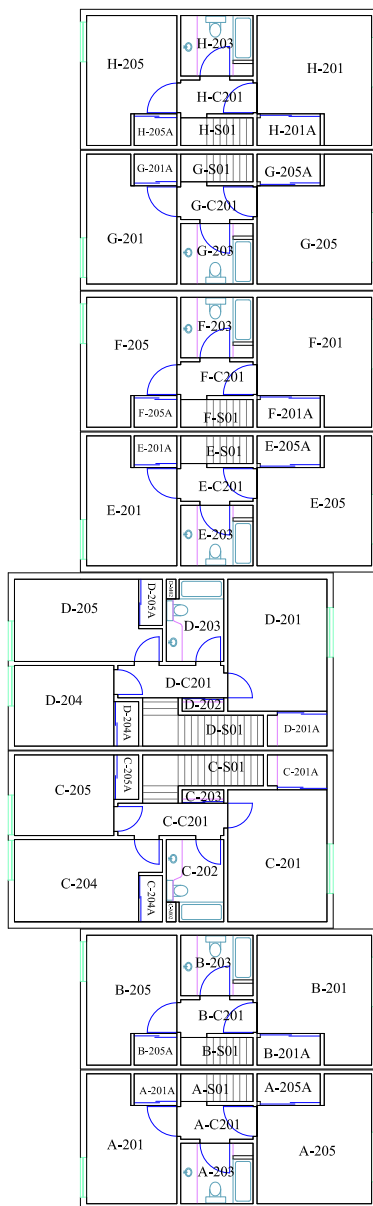

 SECOND FLOOR
TOWNHOUSE APTS. BUILDING 5

 = FIRE EXTINGUISHER
  = AED
  = FIRE DEP. CONNECTION
  = LOCK BOX
  = FIRE ALARM CONTROL PANEL
  = SPRINKLER HEADER
 R = SPRINKLER RISER

DATE CREATED
03-04-19

ADDRESS
620 W. 7TH STREET

Square Feet
3731

AiM ID
1235

**(T05) TOWNHOUSE APARTMENT
BLDG 5**

FLOOR
2

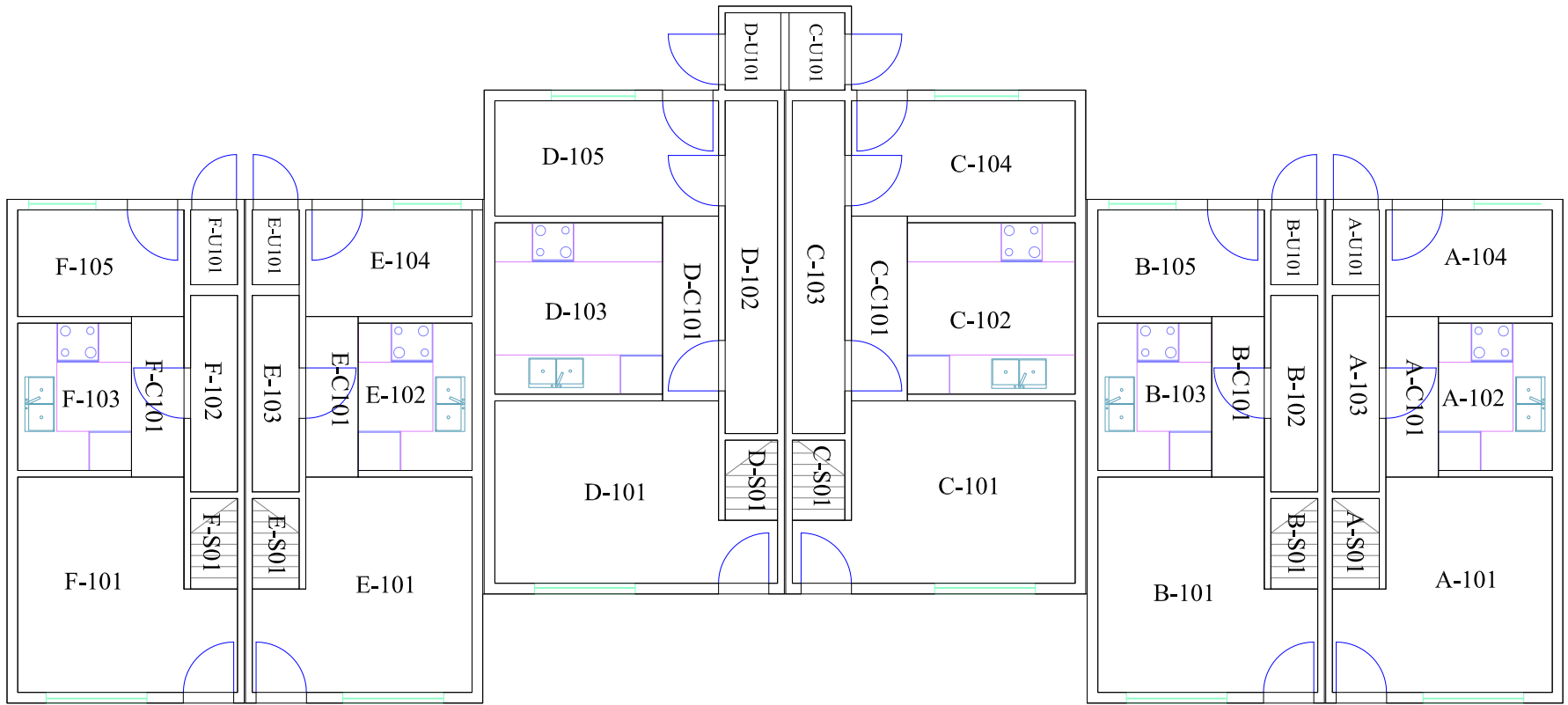

FIRST FLOOR
TOWNHOUSE APTS. BUILDING 6

 = FIRE EXTINGUISHER
  = AED
  = FIRE DEP. CONNECTION
  = LOCK BOX
  = FIRE ALARM CONTROL PANEL
  = SPRINKLER HEADER
 R = SPRINKLER RISER

DATE CREATED
03-04-19

ADDRESS
620 W. 7TH
STREET

Square Feet
2819

AiM ID
1236

**(T06) TOWNHOUSE APARTMENT
BLDG 6**

FLOOR
1

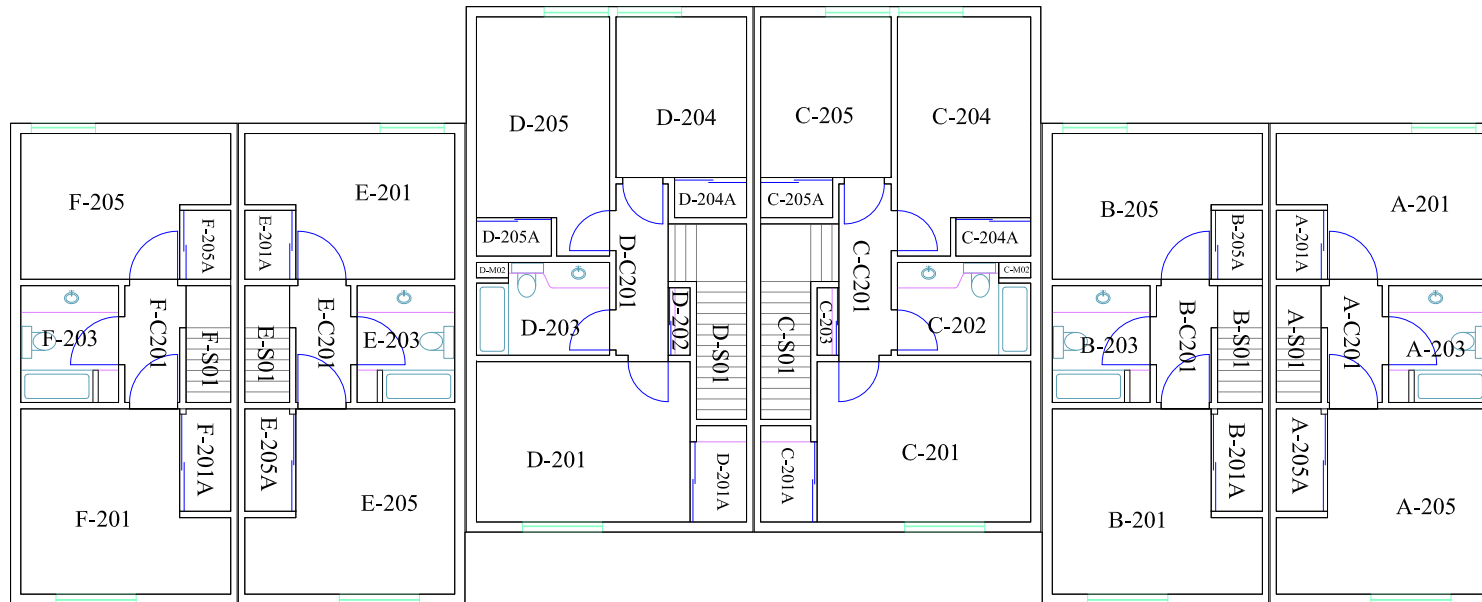

SECOND FLOOR
TOWNHOUSE APTS. BUILDING 6

 = FIRE EXTINGUISHER
  = AED
  = FIRE DEP. CONNECTION
  = LOCK BOX
  = FIRE ALARM CONTROL PANEL
  = SPRINKLER HEADER
 R = SPRINKLER RISER

DATE CREATED 03-04-19	ADDRESS 620 W. 7TH STREET	Square Feet 2879	AiM ID 1236	(T06) TOWNHOUSE APARTMENT BLDG 6	FLOOR 2
---------------------------------	------------------------------	----------------------------	-----------------------	---	-------------------

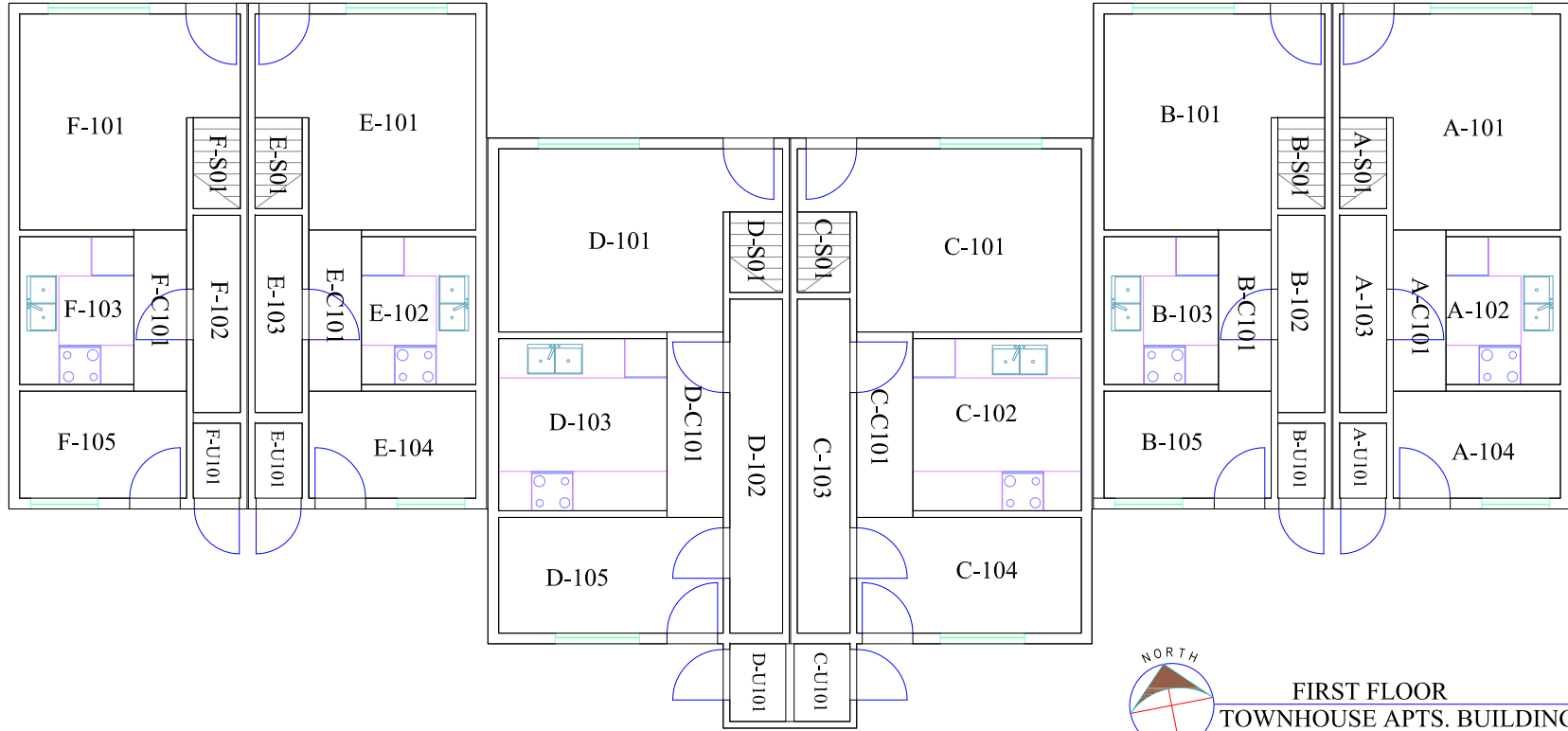

FIRST FLOOR
TOWNHOUSE APTS. BUILDING 7

= FIRE EXTINGUISHER
 = AED
 = FIRE DEP. CONNECTION
 = LOCK BOX
 = FIRE ALARM CONTROL PANEL
 = SPRINKLER HEADER
 R = SPRINKLER RISER

DATE CREATED
03-04-19

ADDRESS
620 W. 7TH STREET

Square Feet
2818

AiM ID
1237

**(T07) TOWNHOUSE APARTMENT
BLDG 7**

FLOOR
1

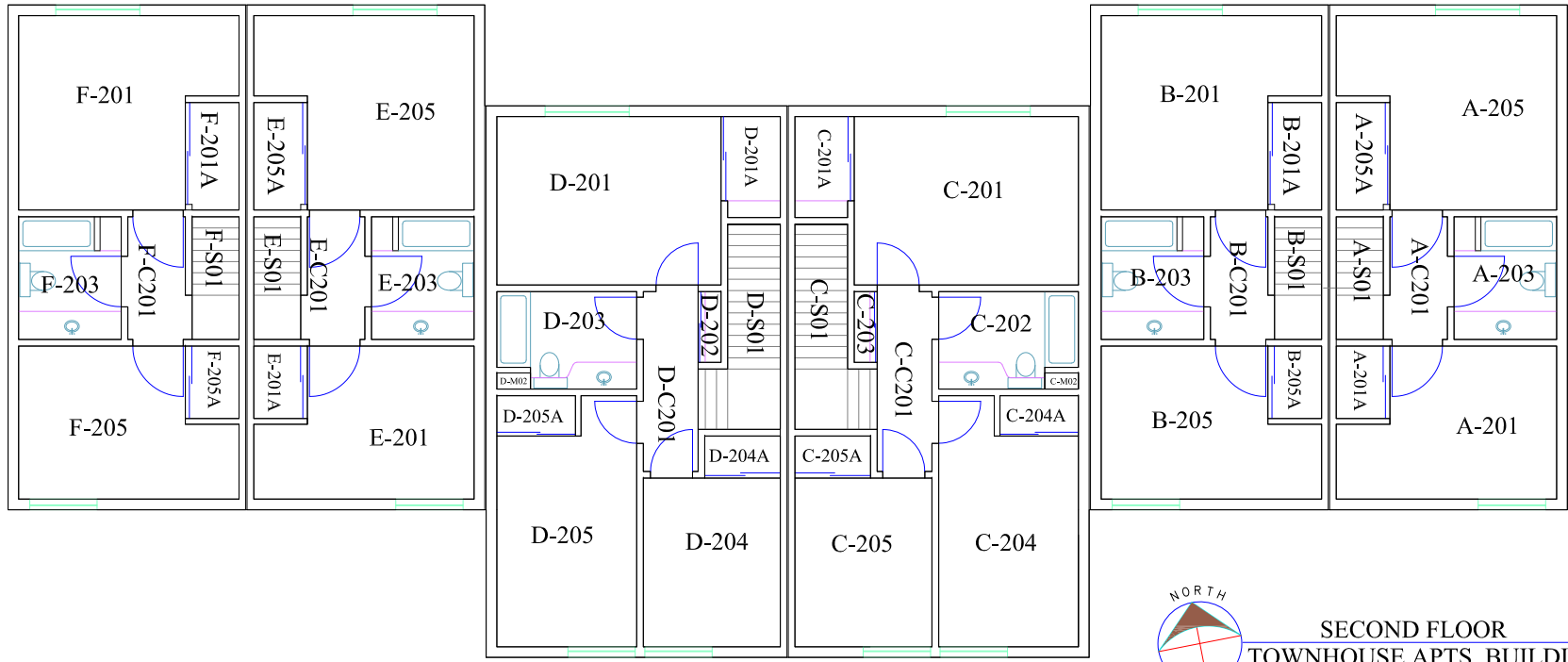

SECOND FLOOR
TOWNHOUSE APTS. BUILDING 7

 = FIRE EXTINGUISHER
  = AED
  = FIRE DEP. CONNECTION
  = LOCK BOX
  = FIRE ALARM CONTROL PANEL
  = SPRINKLER HEADER
  = SPRINKLER RISER

DATE CREATED
03-04-19

ADDRESS
620 W. 7TH STREET

Square Feet
2878

AiM ID
1237

**(T07) TOWNHOUSE APARTMENT
BLDG 7**

FLOOR
2

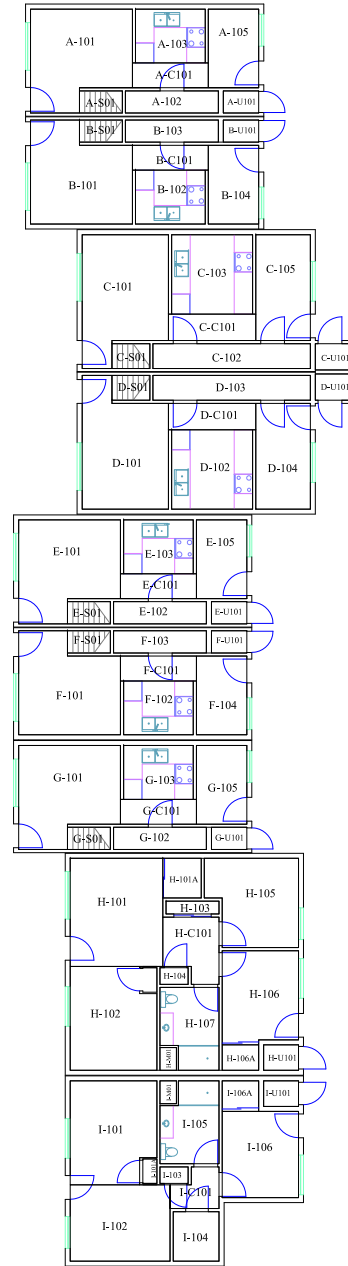

 FIRST FLOOR
TOWNHOUSE APTS. BUILDING 8

 = FIRE EXTINGUISHER
  = AED
  = FIRE DEP. CONNECTION
  = LOCK BOX
  = FIRE ALARM CONTROL PANEL
  = SPRINKLER HEADER
 R = SPRINKLER RISER

DATE CREATED
03-04-19

ADDRESS
620 W. 7TH
STREET

Square Feet
4727

AiM ID
1238

**(T08) TOWNHOUSE APARTMENT
BLDG 8**

FLOOR
1

DRAWINGS ARE NOT TO SCALE

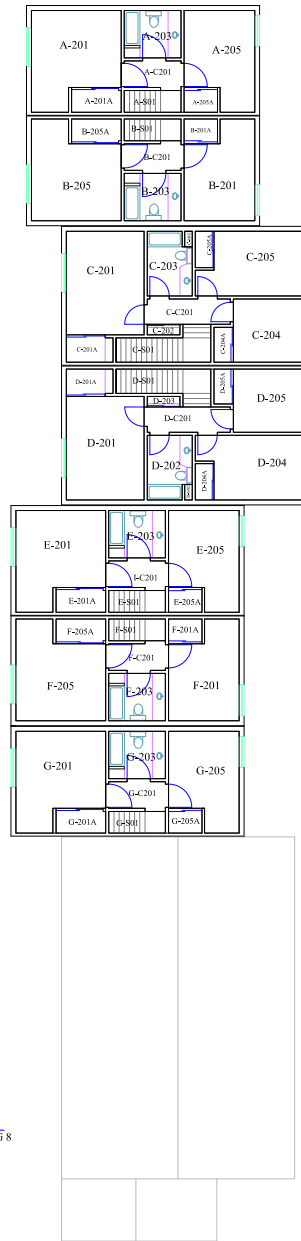

 SECOND FLOOR
TOWNHOUSE APTS. BUILDING 8

 = FIRE EXTINGUISHER
  = AED
  = FIRE DEP. CONNECTION
  = LOCK BOX
  = FIRE ALARM CONTROL PANEL
  = SPRINKLER HEADER
  = SPRINKLER RISER

DATE CREATED
03-04-19

ADDRESS
620 W. 7TH
STREET

Square Feet
3305

AiM ID
1238

**(T08) TOWNHOUSE APARTMENT
BLDG 8**

FLOOR
2

DRAWINGS ARE NOT TO SCALE

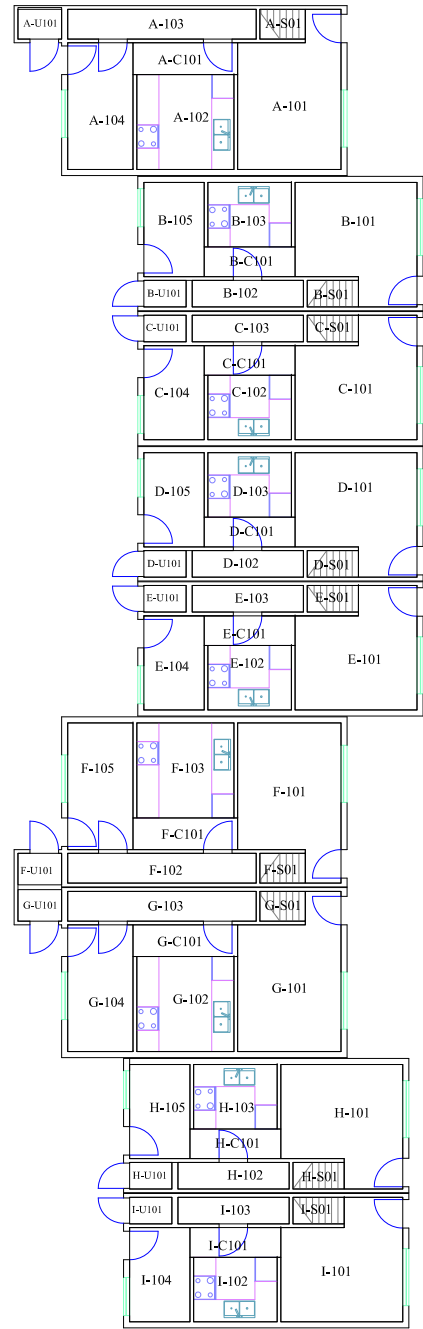

 = FIRE EXTINGUISHER
  = AED
  = FIRE DEP. CONNECTION
  = LOCK BOX
  = FIRE ALARM CONTROL PANEL
  = SPRINKLER HEADER
  = SPRINKLER RISER

DATE CREATED
03-04-19

ADDRESS
620 W. 7TH
STREET

Square Feet
4229

AiM ID
1239

(T09) TOWNHOUSE APARTMENT
BLDG 9

FLOOR
1

DRAWINGS ARE NOT TO SCALE

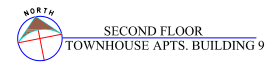
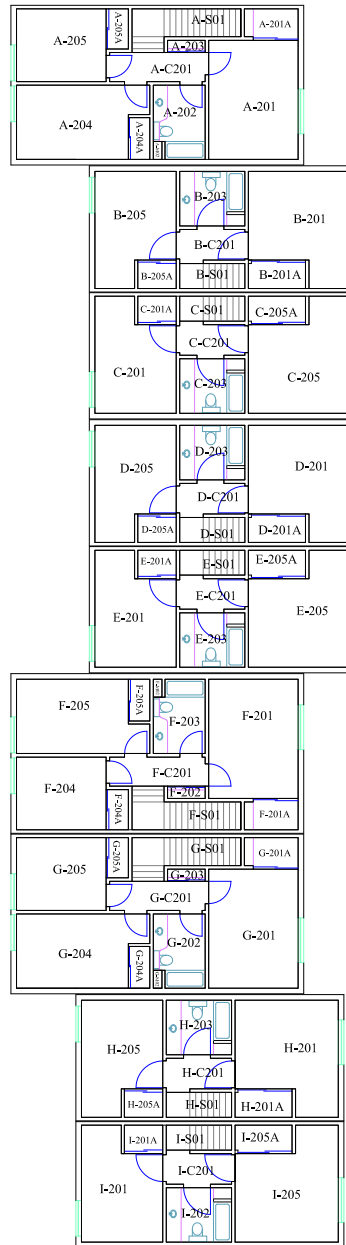

 = FIRE EXTINGUISHER
  = AED
  = FIRE DEP. CONNECTION
  = LOCK BOX
  = FIRE ALARM CONTROL PANEL
  = SPRINKLER HEADER
 R = SPRINKLER RISER

DATE CREATED
03-04-19

ADDRESS
620 W. 7TH
STREET

Square Feet
4319

AiM ID
1239

**(T09) TOWNHOUSE APARTMENT
BLDG 9**

FLOOR
2

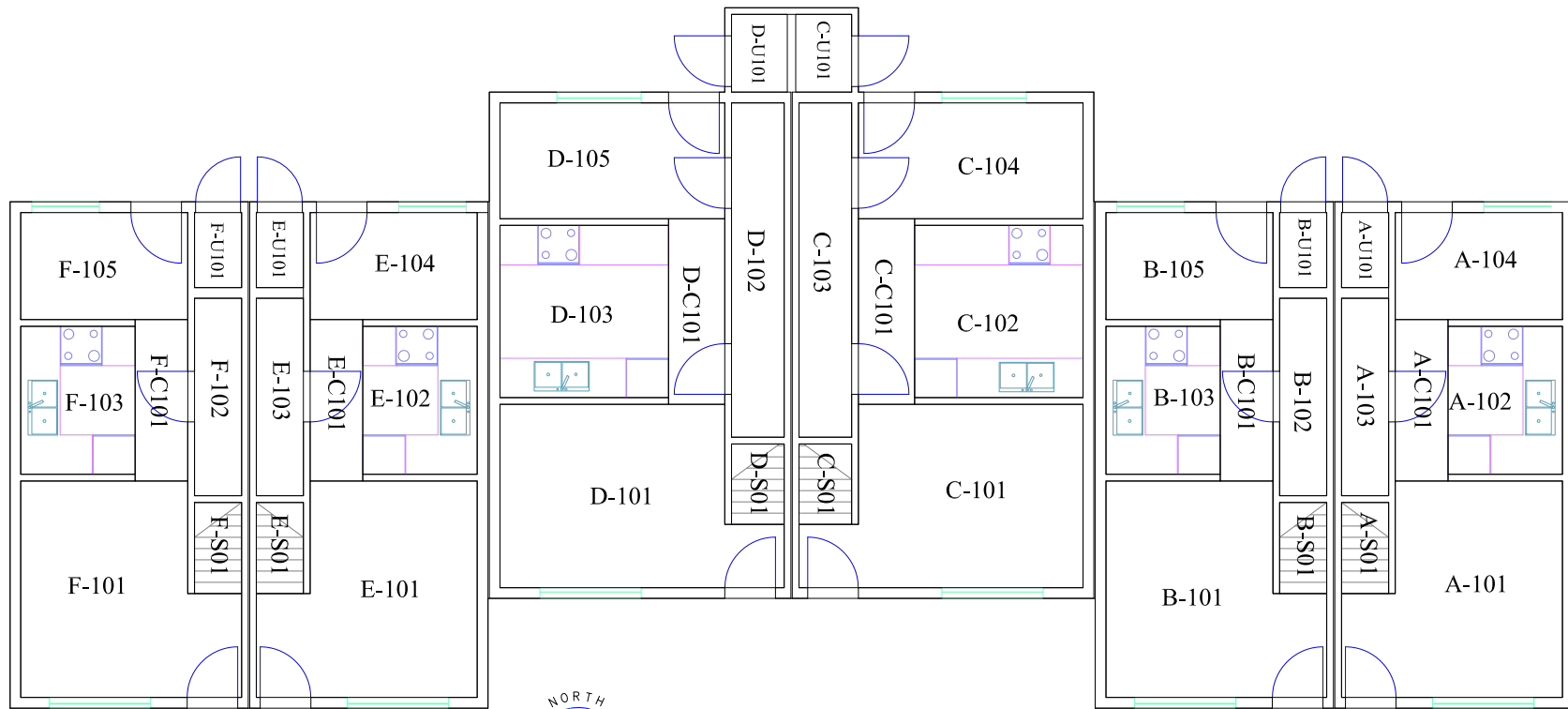

FIRST FLOOR
TOWNHOUSE APTS. BUILDING 10

 = FIRE EXTINGUISHER
  = AED
  = FIRE DEP. CONNECTION
  = LOCK BOX
  = FIRE ALARM CONTROL PANEL
  = SPRINKLER HEADER
  = SPRINKLER RISER

DATE CREATED
03-04-19

ADDRESS
620 W. 7TH
STREET

Square Feet
2819

AiM ID
1240

**(T10) TOWNHOUSE APARTMENT
BLDG 10**

FLOOR
1

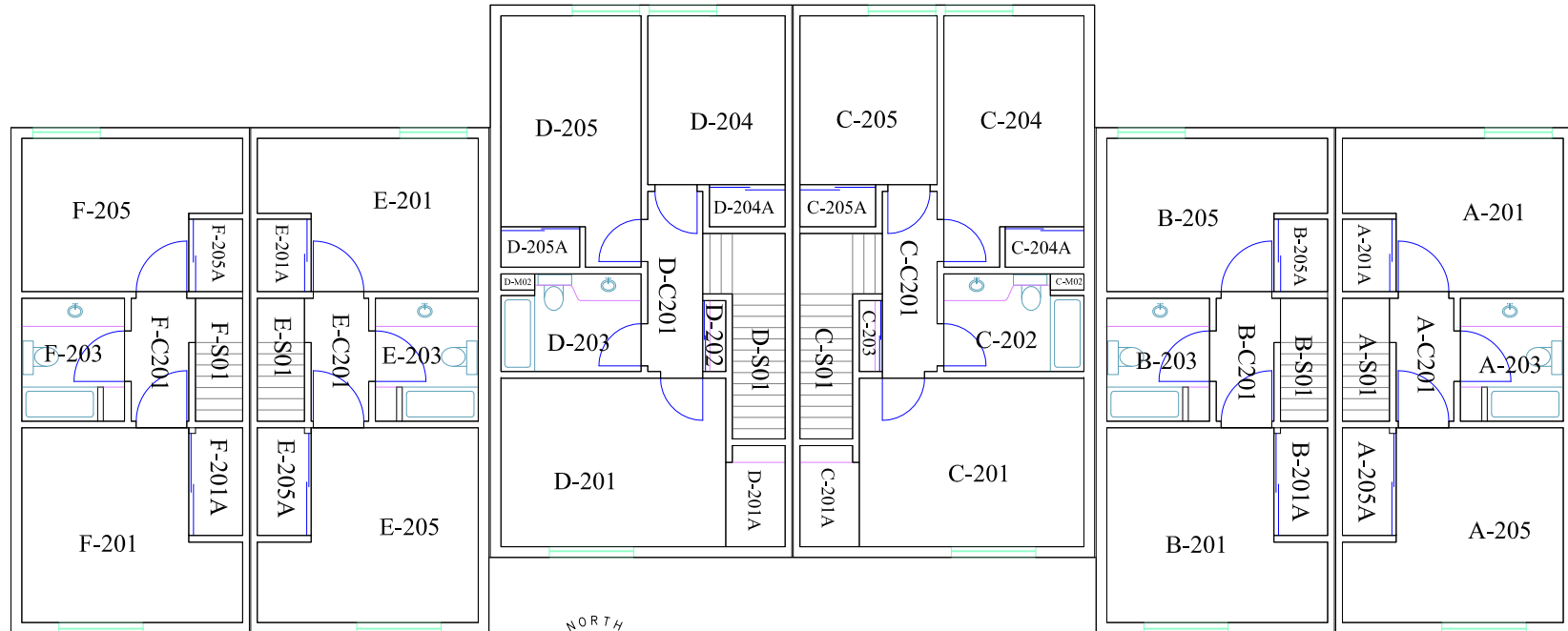

SECOND FLOOR
TOWNHOUSE APTS. BUILDING 10

 = FIRE EXTINGUISHER
  = AED
  = FIRE DEP. CONNECTION
  = LOCK BOX
  = FIRE ALARM CONTROL PANEL
  = SPRINKLER HEADER
 R = SPRINKLER RISER

DATE CREATED
03-04-19

ADDRESS
620 W. 7TH
STREET

Square Feet
2879

AiM ID
1240

**(T10) TOWNHOUSE APARTMENT
BLDG 10**

FLOOR
2

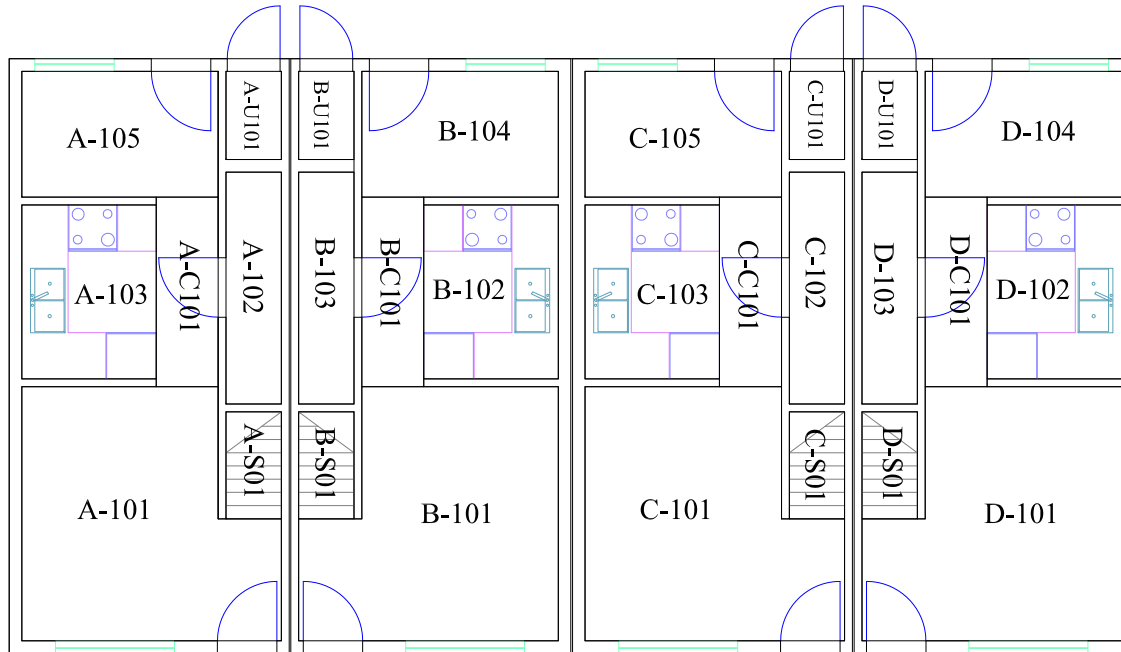

FIRST FLOOR
TOWNHOUSE APTS. BUILDING 11

 = FIRE EXTINGUISHER
  = AED
  = FIRE DEP. CONNECTION
  = LOCK BOX
  = FIRE ALARM CONTROL PANEL
  = SPRINKLER HEADER
  = SPRINKLER RISER

DATE CREATED
02-05-19

ADDRESS
620 W. 7TH
STREET

Square Feet
1702

AiM ID
1241

(T11) TOWNHOUSE APARTMENT
BLDG 11

FLOOR
1

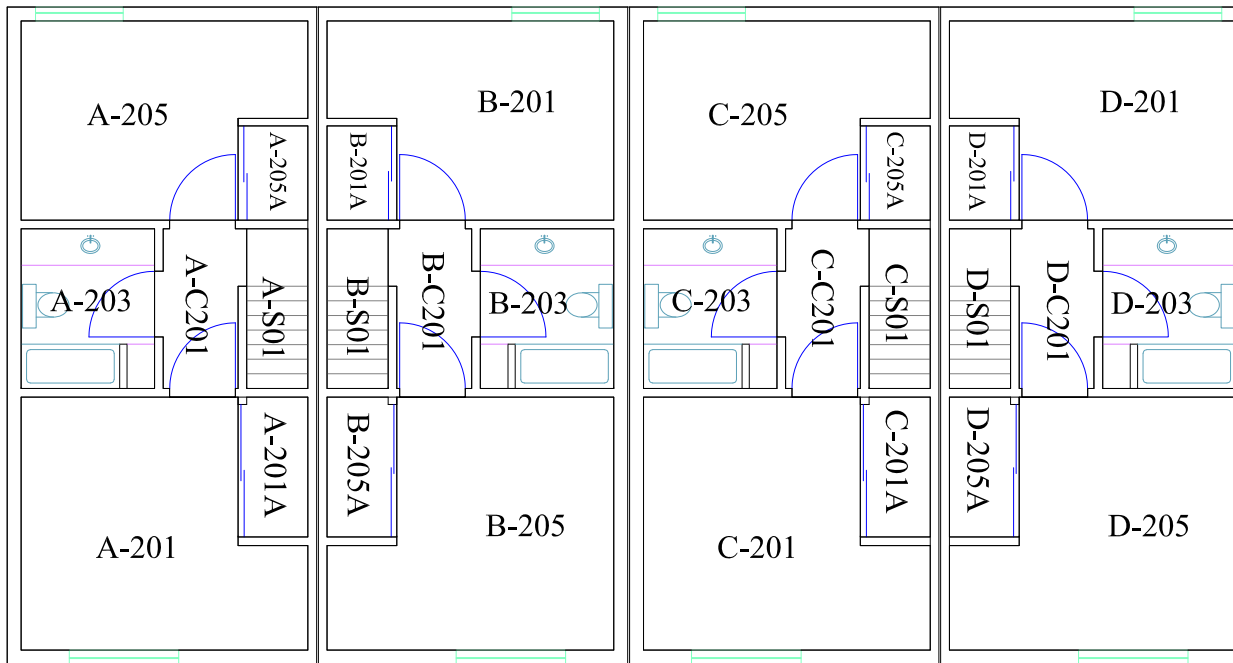

SECOND FLOOR
TOWNHOUSE APTS. BUILDING 11

 = FIRE EXTINGUISHER
  = AED
  = FIRE DEP. CONNECTION
  = LOCK BOX
  = FIRE ALARM CONTROL PANEL
  = SPRINKLER HEADER
  = SPRINKLER RISER

DATE CREATED
03-05-19

ADDRESS
620 W. 7TH
STREET

Square Feet
1703

AiM ID
1241

(T11) TOWNHOUSE APARTMENT
BLDG 11

FLOOR
2

DRAWINGS ARE NOT TO SCALE

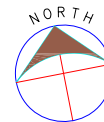
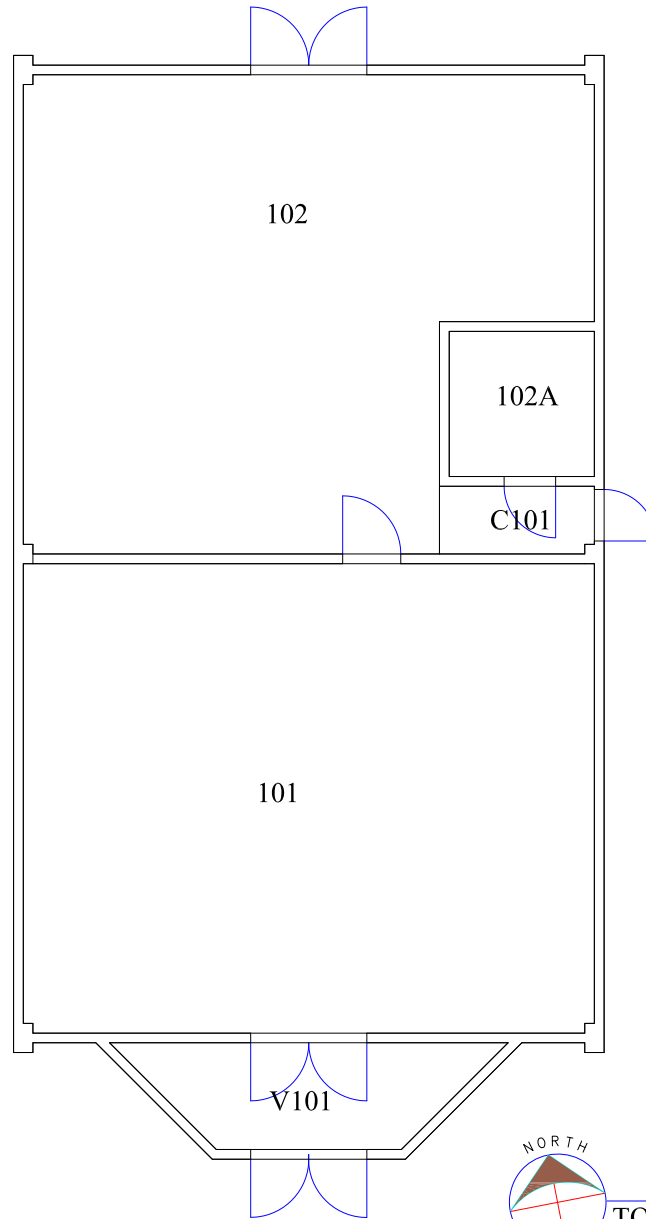

FIRST FLOOR
TOWNHOUSE APTS. BUILDING 12

 = FIRE EXTINGUISHER  = AED  = FIRE DEP. CONNECTION  = LOCK BOX  = FIRE ALARM CONTROL PANEL  = SPRINKLER HEADER **R** = SPRINKLER RISER

DATE CREATED 03-05-19	ADDRESS 620 W. 7TH STREET	Square Feet 1638	AiM ID 1242	(T12) TOWNHOUSE APARTMENT BLDG 12	FLOOR 1
---------------------------------	------------------------------	----------------------------	-----------------------	--	-------------------

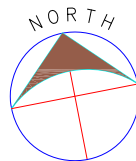
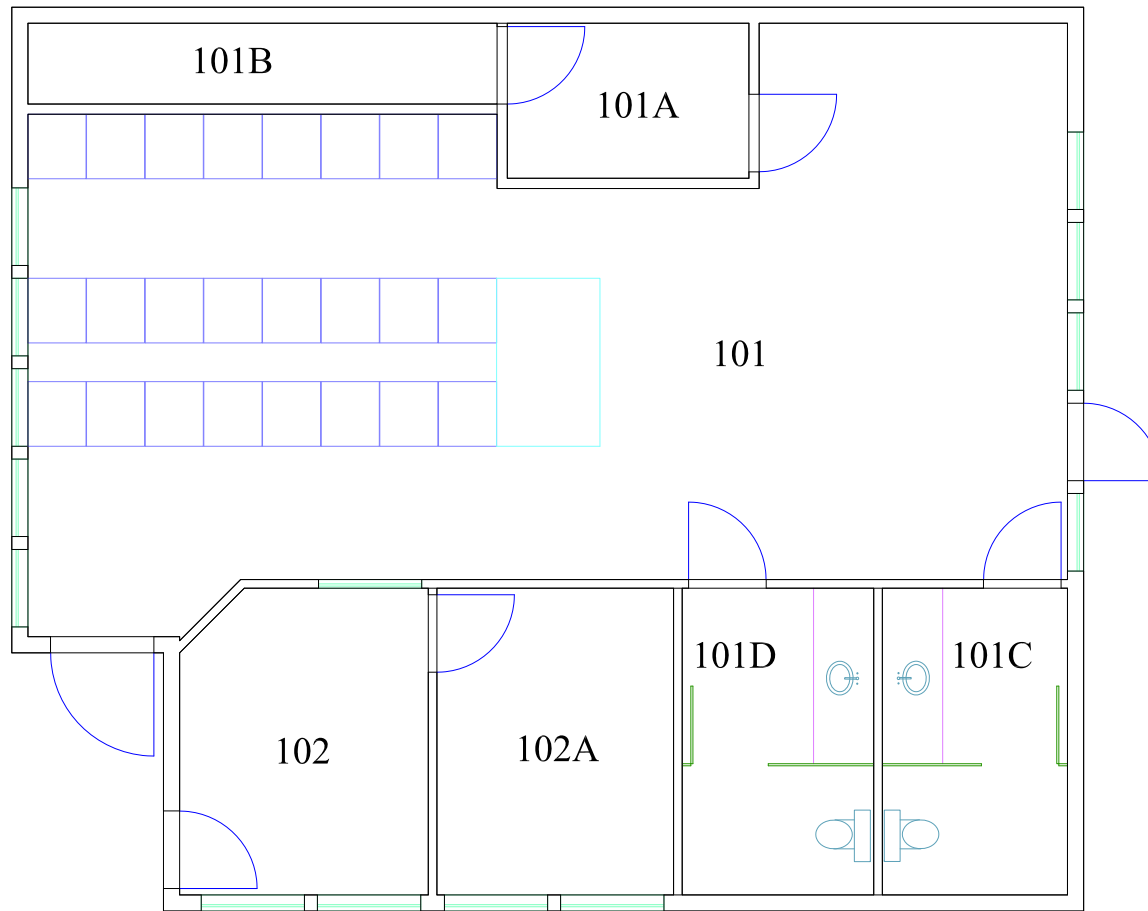

FIRST FLOOR - LAUNDRY
TOWNHOUSE APTS. BUILDING 13

= FIRE EXTINGUISHER
 = AED
 = FIRE DEP. CONNECTION
 = LOCK BOX
 = FIRE ALARM CONTROL PANEL
 = SPRINKLER HEADER
 = SPRINKLER RISER

DATE CREATED
03-05-19

ADDRESS
 620 W. 7TH
 STREET

Square Feet
2879



AiM ID
1243

(T13) TOWNHOUSE APARTMENT
BLDG 13

FLOOR
1

DRAWINGS ARE NOT TO SCALE



 FICM Code 210 Classroom
 FICM Code 110 Classroom

 = FIRE EXTINGUISHER  = AED  = FIRE DEP. CONNECTION  = LOCK BOX  = FIRE ALARM CONTROL PANEL  = SPRINKLER HEADER **R** = SPRINKLER RISER  = Bottle Filler

DATE REVISED
12/20/2020

ADDRESS
501 Quad LN



Square Feet
4365

BLDG NO
1121

(TAW) TAWANKA COMMONS
BASEMENT

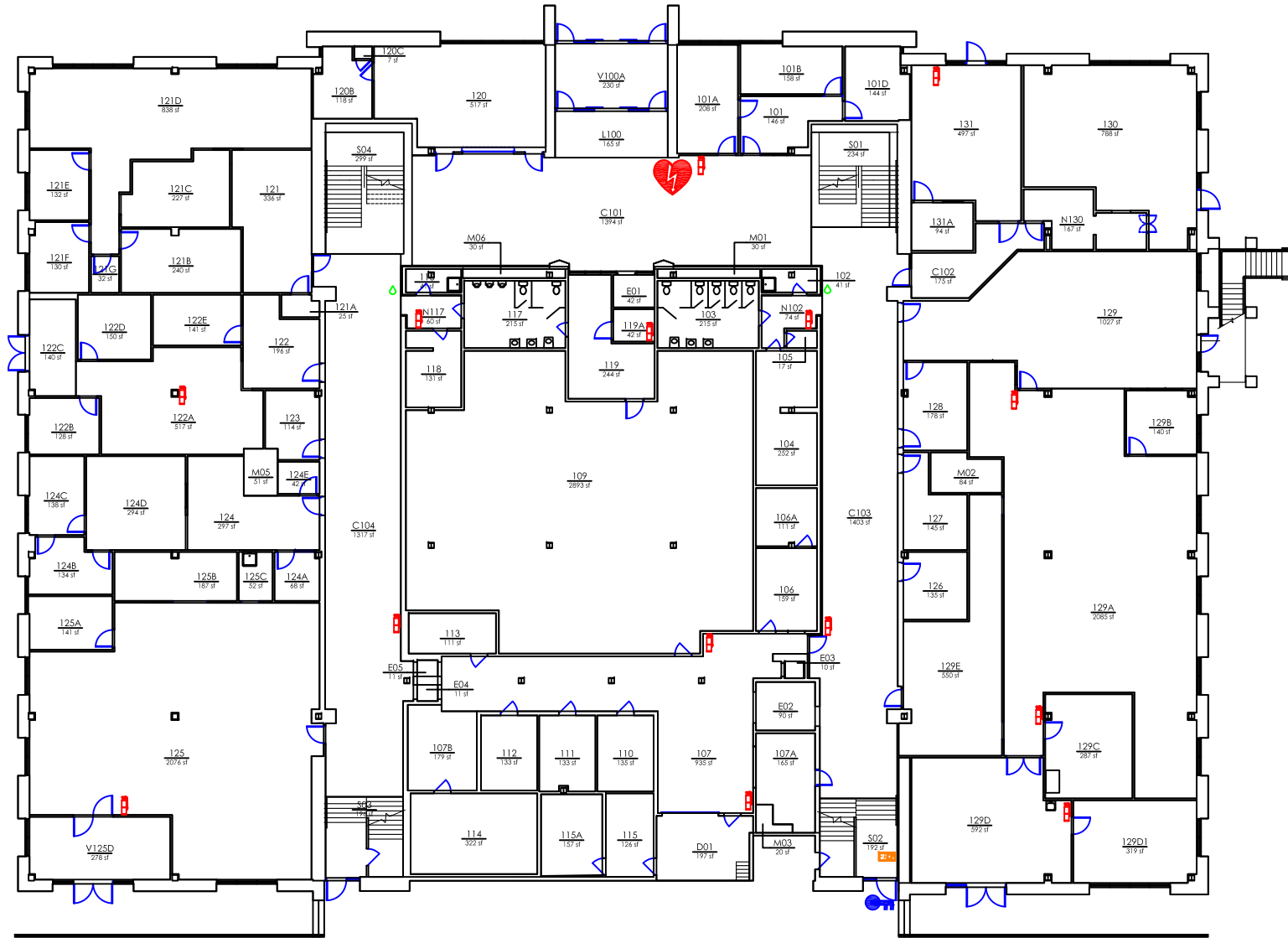
FLOOR
0



-  FICM Code 210 Classroom
-  FICM Code 110 Classroom

-  = FIRE EXTINGUISHER
-  = AED
-  = FIRE DEP. CONNECTION
-  = LOCK BOX
-  = FIRE ALARM CONTROL PANEL
-  = SPRINKLER HEADER
-  = SPRINKLER RISER
-  = Bottle Filler

DATE REVISED
12/20/2020

ADDRESS
501 Quad LN

Square Feet
12/20/2020

BLDG NO
1121

(TAW) TAWANKA COMMONS
FIRST FLOOR

FLOOR
1

DRAWINGS ARE NOT TO SCALE

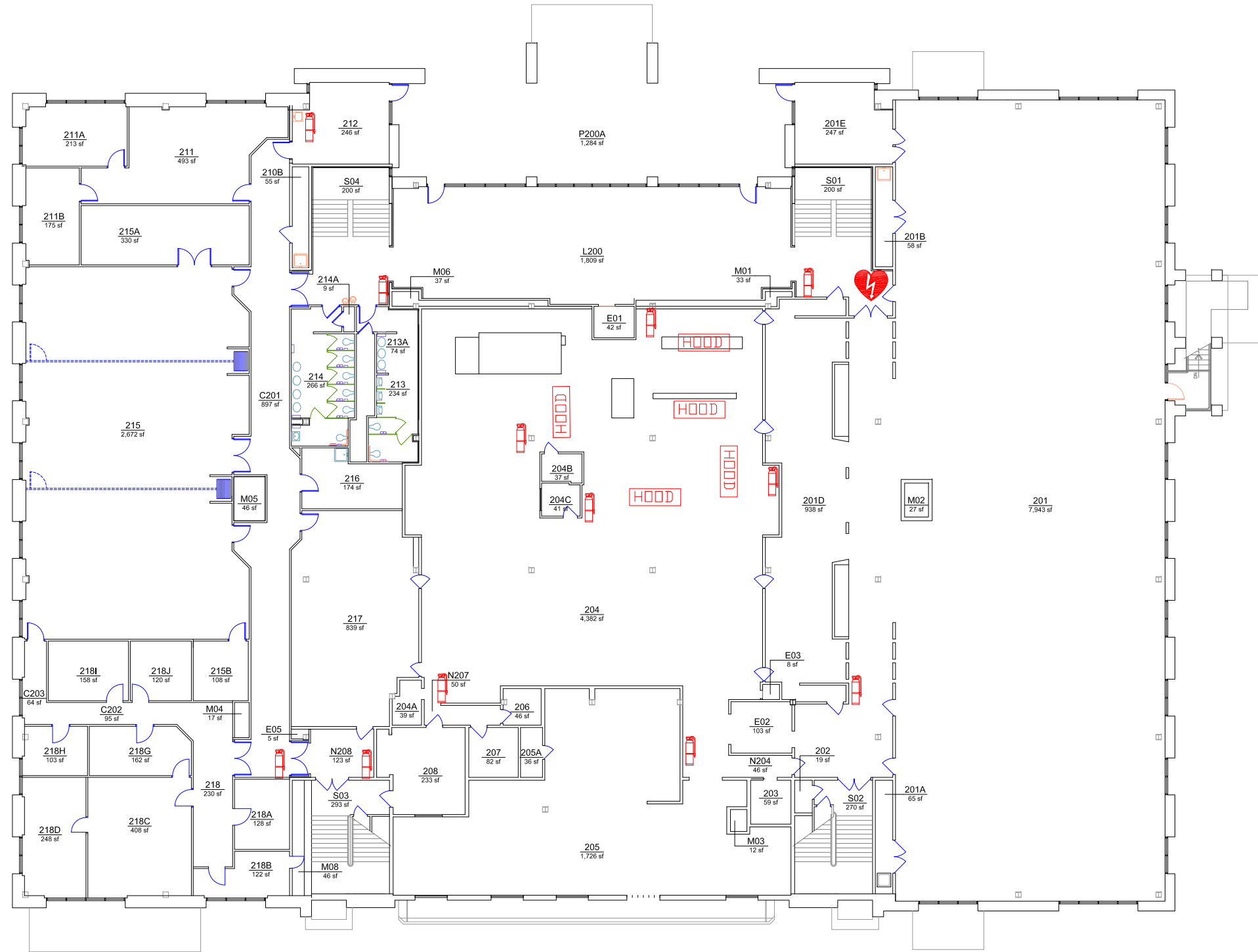

- HOOD Extinguisher Hood
- FICM Code 210 Classroom
- FICM Code 110 Classroom

- EXTINGUISHER = FIRE EXTINGUISHER
- ♥ = AED
- ⚡ ⚡ = FIRE DEP. CONNECTION
- 🔑 = LOCK BOX
- FACP = FIRE ALARM CONTROL PANEL
- = SPRINKLER HEADER
- R = SPRINKLER RISER
- 💧 = Bottle Filler

DATE REVISED	ADDRESS	Square Feet	BLDG NO	(TAW) TAWANKA COMMONS SECOND FLOOR	FLOOR 2
2/1/2022	501 Quad LN	31356	1121		

DRAWINGS ARE NOT TO SCALE



THIRD FLOOR
TAWANKA COMMONS

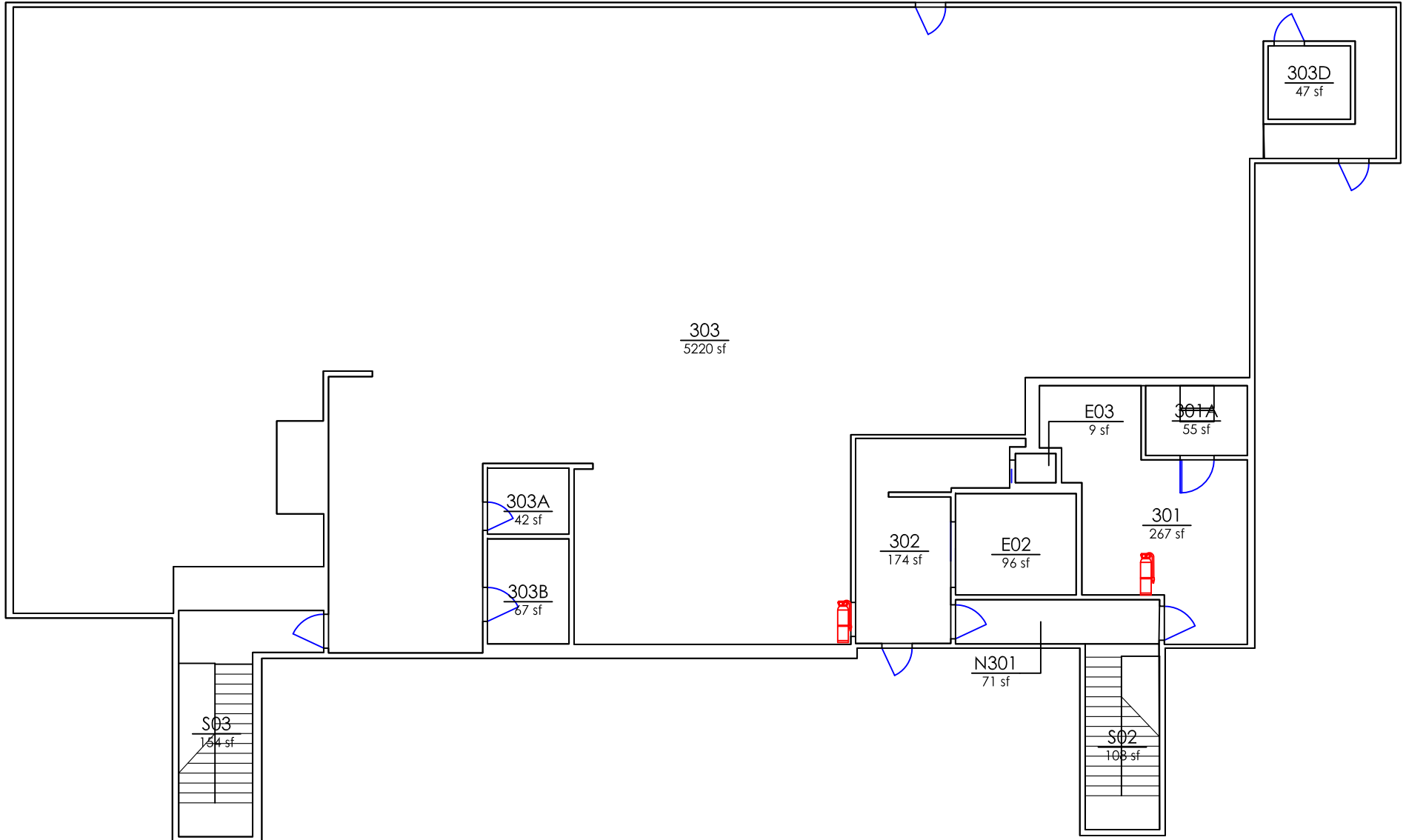

- FICM Code 210 Classroom
- FICM Code 110 Classroom

- = FIRE EXTINGUISHER
- = AED
- = FIRE DEP. CONNECTION
- = LOCK BOX
- = FIRE ALARM CONTROL PANEL
- = SPRINKLER HEADER
- = SPRINKLER RISER
- = Bottle Filler

DATE REVISED
12/20/2020

ADDRESS
501 Quad LN

Square Feet
6754

BLDG NO
1121

(TAW) TAWANKA COMMONS
THIRD FLOOR

FLOOR
3

FIRST FLOOR THEATRE BUILDING

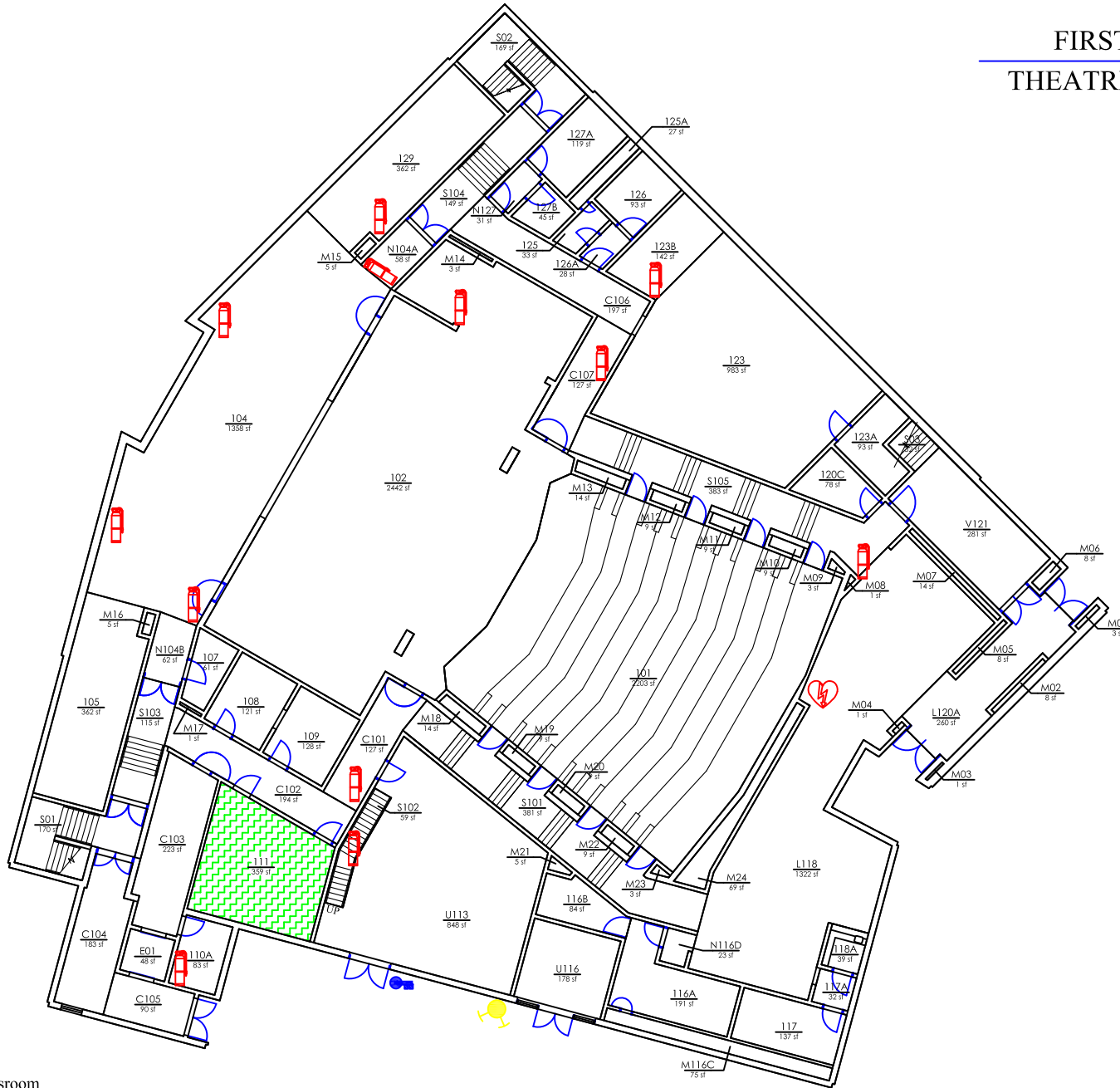

- FICM Code 210 Classroom
- FICM Code 110 Classroom

- = FIRE EXTINGUISHER
- = AED
- = FIRE DEP. CONNECTION
- = LOCK BOX
- = FIRE ALARM CONTROL PANEL
- = SPRINKLER HEADER
- = SPRINKLER RISER
- = Bottle Filler

DATE REVISED	ADDRESS	Square Feet	BLDG NO	(THE) UNIVERSITY THEATER FIRST FLOOR	FLOOR 1
09/17/2020	1003 Washington ST	17248	1151		

DRAWINGS ARE NOT TO SCALE

MEZZANINE LEVEL
THEATRE BUILDING

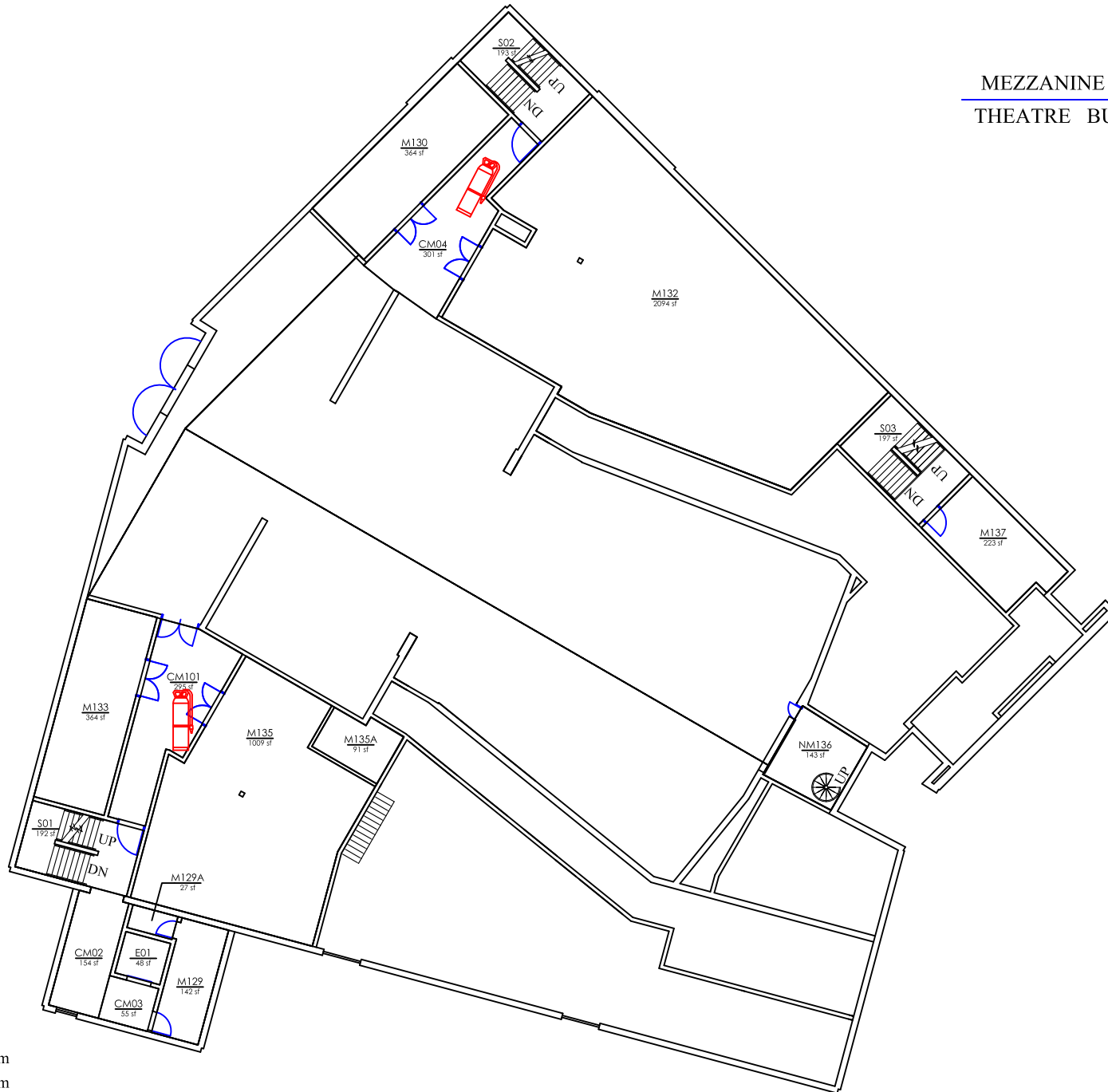

- FICM Code 210 Classroom
- FICM Code 110 Classroom



- = FIRE EXTINGUISHER
- = AED
- = FIRE DEP. CONNECTION
- = LOCK BOX
- = FIRE ALARM CONTROL PANEL
- = SPRINKLER HEADER
- = SPRINKLER RISER
- = Bottle Filler

DATE REVISED	ADDRESS	Square Feet	BLDG NO	(THE) UNIVERSITY THEATER MEZZANINE	FLOOR
09/17/2020	1003 Washington ST	6089	1151		1.5

DRAWINGS ARE NOT TO SCALE

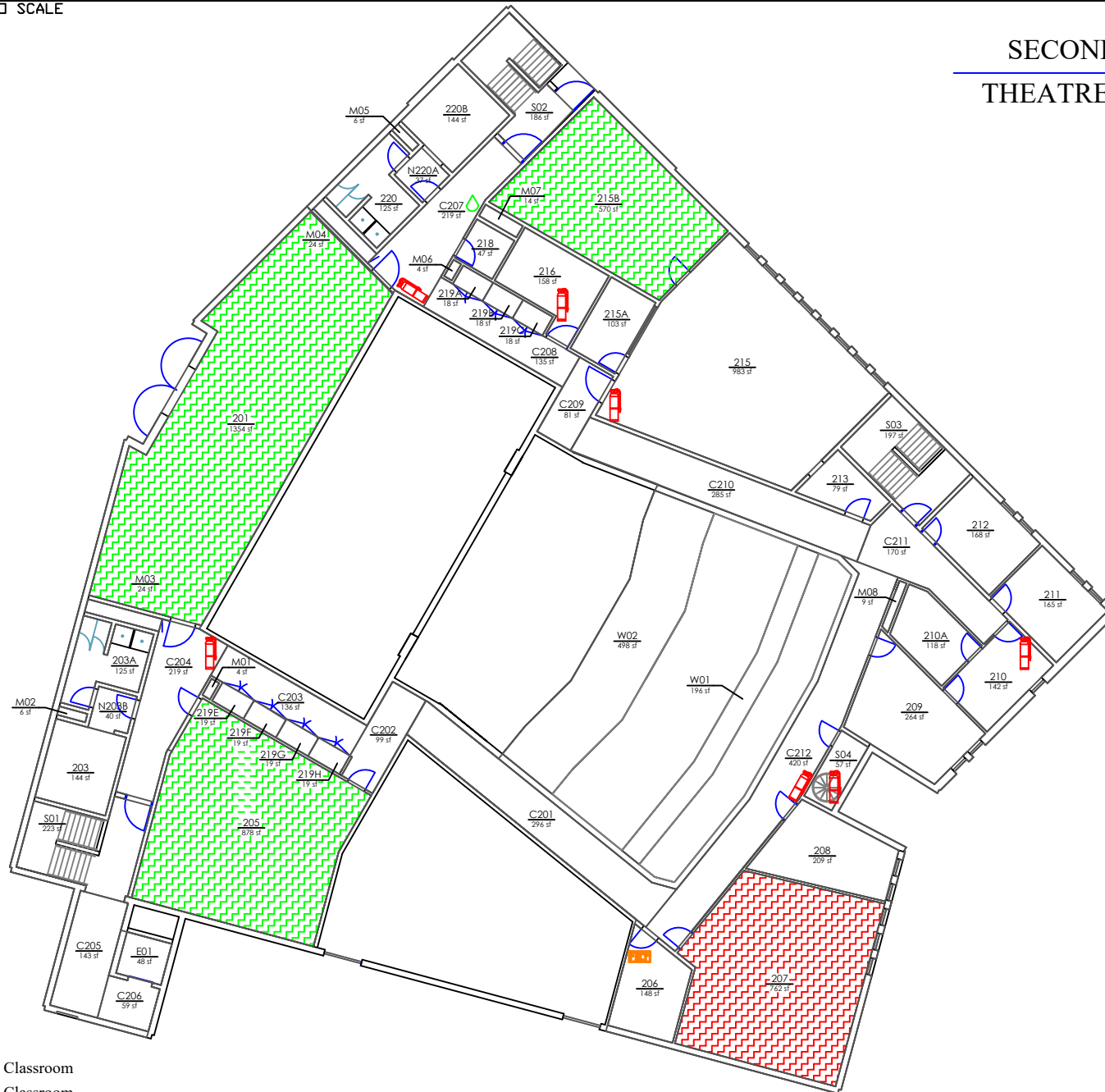
SECOND FLOOR
THEATRE BUILDING



 FICM Code 210 Classroom
 FICM Code 110 Classroom

 = FIRE EXTINGUISHER  = AED  = FIRE DEP. CONNECTION  = LOCK BOX  = FIRE ALARM CONTROL PANEL  = SPRINKLER HEADER **R** = SPRINKLER RISER  = Bottle Filler

DATE REVISED
02/01/2022

ADDRESS
1003 Washington ST

Square Feet
11738



BLDG NO
1151

(THE) UNIVERSITY THEATER
SECOND FLOOR

FLOOR
2

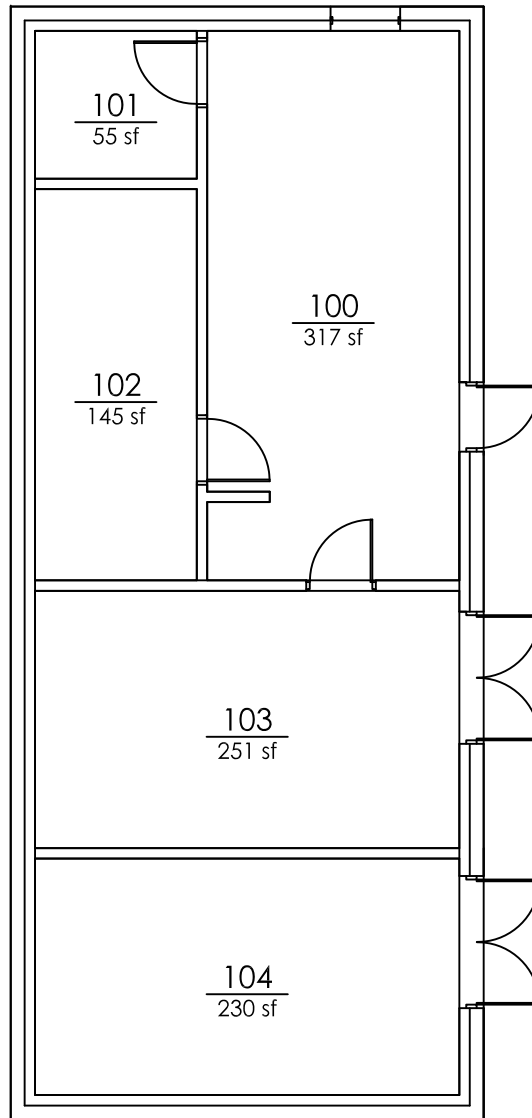
DRAWINGS ARE NOT TO SCALE



 FICM Code 210 Classroom
 FICM Code 110 Classroom

 = FIRE EXTINGUISHER  = AED  = FIRE DEP. CONNECTION  = LOCK BOX  = FIRE ALARM CONTROL PANEL  = SPRINKLER HEADER **R** = SPRINKLER RISER  = Bottle Filler

DATE REVISED
12/20/2020

ADDRESS
1456 Playfield
LN

Square Feet

BLDG NO
1711

(TMB) Treatment Building

FLOOR
1

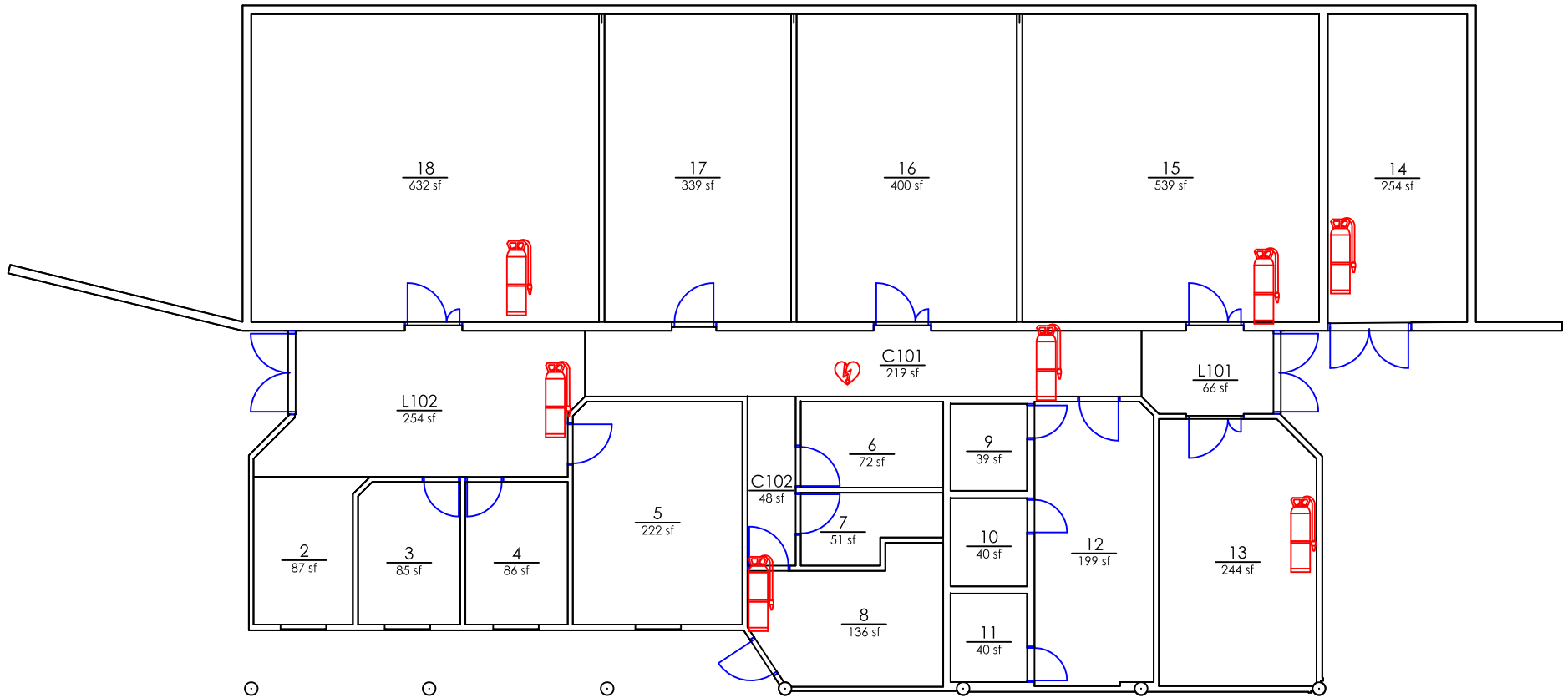

- FICM Code 210 Classroom
- FICM Code 110 Classroom

- = FIRE EXTINGUISHER
- = AED
- = FIRE DEP. CONNECTION
- = LOCK BOX
- = FIRE ALARM CONTROL PANEL
- = SPRINKLER HEADER
- R** = SPRINKLER RISER
- = Bottle Filler

DATE REVISED
12/23/2020

ADDRESS
22111 S Cheney
Plaza RD

Square Feet
4435



BLDG NO
1710

(TUR) TURNBULL LABORATORY
FLOOR PLAN

FLOOR
1

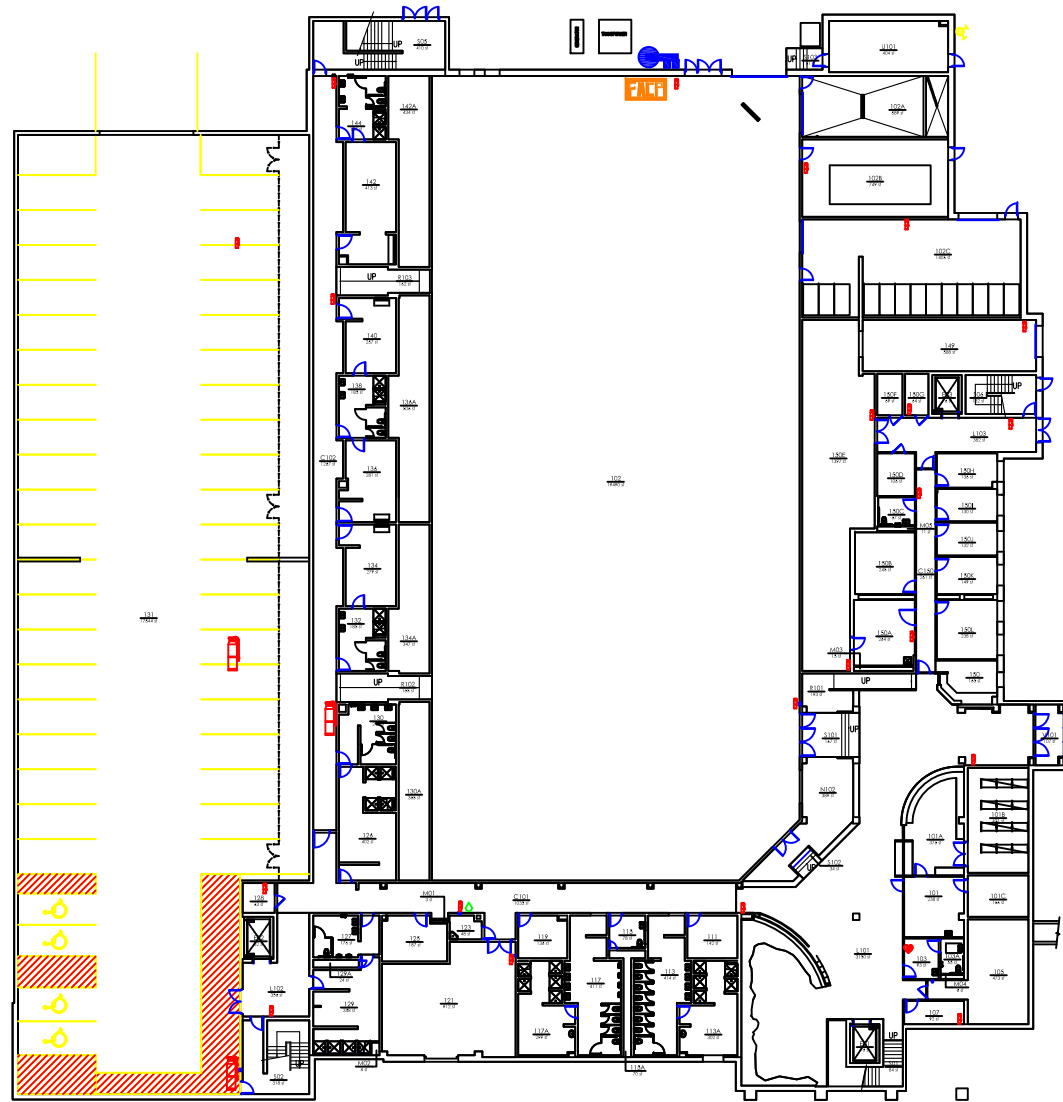
DRAWINGS ARE NOT TO SCALE



 FICM Code 210 Classroom
 FICM Code 110 Classroom

 = FIRE EXTINGUISHER  = AED  = FIRE DEP. CONNECTION  = LOCK BOX  = FIRE ALARM CONTROL PANEL  = SPRINKLER HEADER **R** = SPRINKLER RISER  = Bottle Filler

DATE REVISED
12/23/2020

ADDRESS
1012 Cedar St

Square Feet
66658

BLDG NO
1470

(URC) UNIVERSITY RECREATIONAL CENTER
FIRST FLOOR

FLOOR
1

DRAWINGS ARE NOT TO SCALE

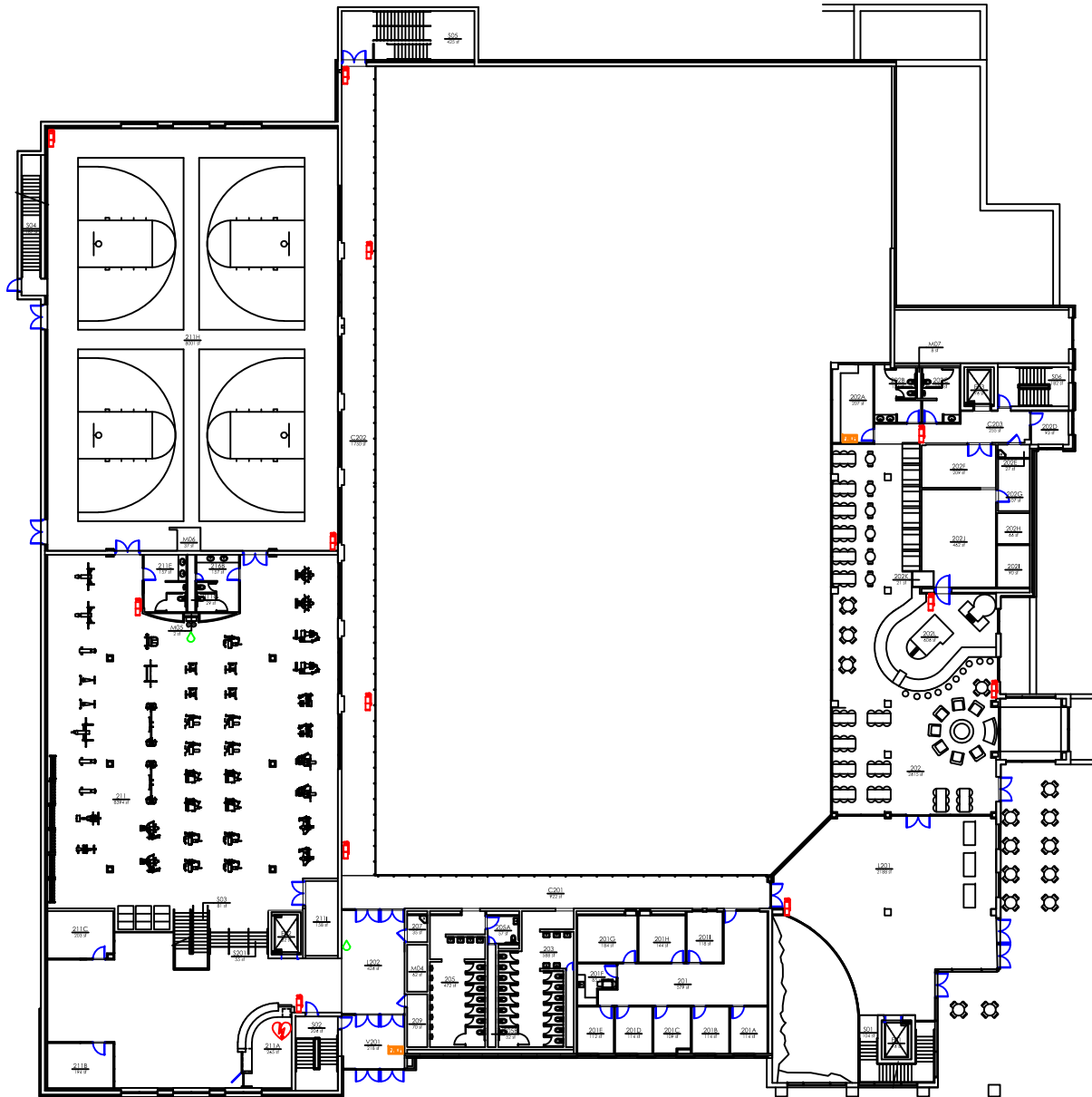

- HOOD Hood
- FICM Code 210 Classroom
- FICM Code 110 Classroom

- = FIRE EXTINGUISHER
- = AED
- = FIRE DEP. CONNECTION
- = LOCK BOX
- = FIRE ALARM CONTROL PANEL
- = SPRINKLER HEADER
- R = SPRINKLER RISER
- = Bottle Filler

DATE REVISED
12/27/2020

ADDRESS
1012 Cedar St

Square Feet
35728



BLDG NO
1470

(URC) UNIVERSITY RECREATIONAL
CENTER SECOND FLOOR

FLOOR
2

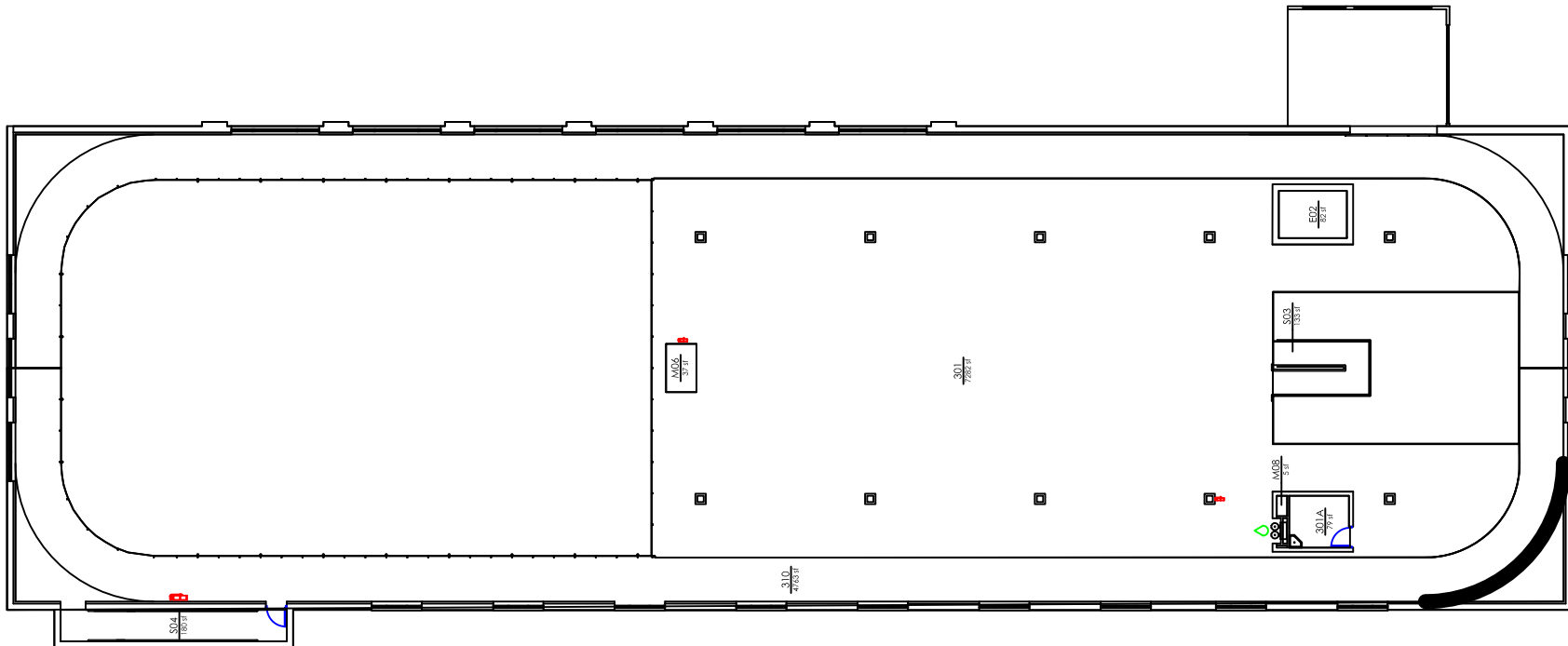
DRAWINGS ARE NOT TO SCALE



 FICM Code 210 Classroom
 FICM Code 110 Classroom

 = FIRE EXTINGUISHER  = AED  = FIRE DEP. CONNECTION  = LOCK BOX  = FIRE ALARM CONTROL PANEL  = SPRINKLER HEADER **R** = SPRINKLER RISER  = Bottle Filler

DATE REVISED
12/28/2020

ADDRESS
1012 Cedar St



Square Feet
13104

BLDG NO
1470

(URC) UNIVERSITY RECREATIONAL CENTER
THIRD FLOOR

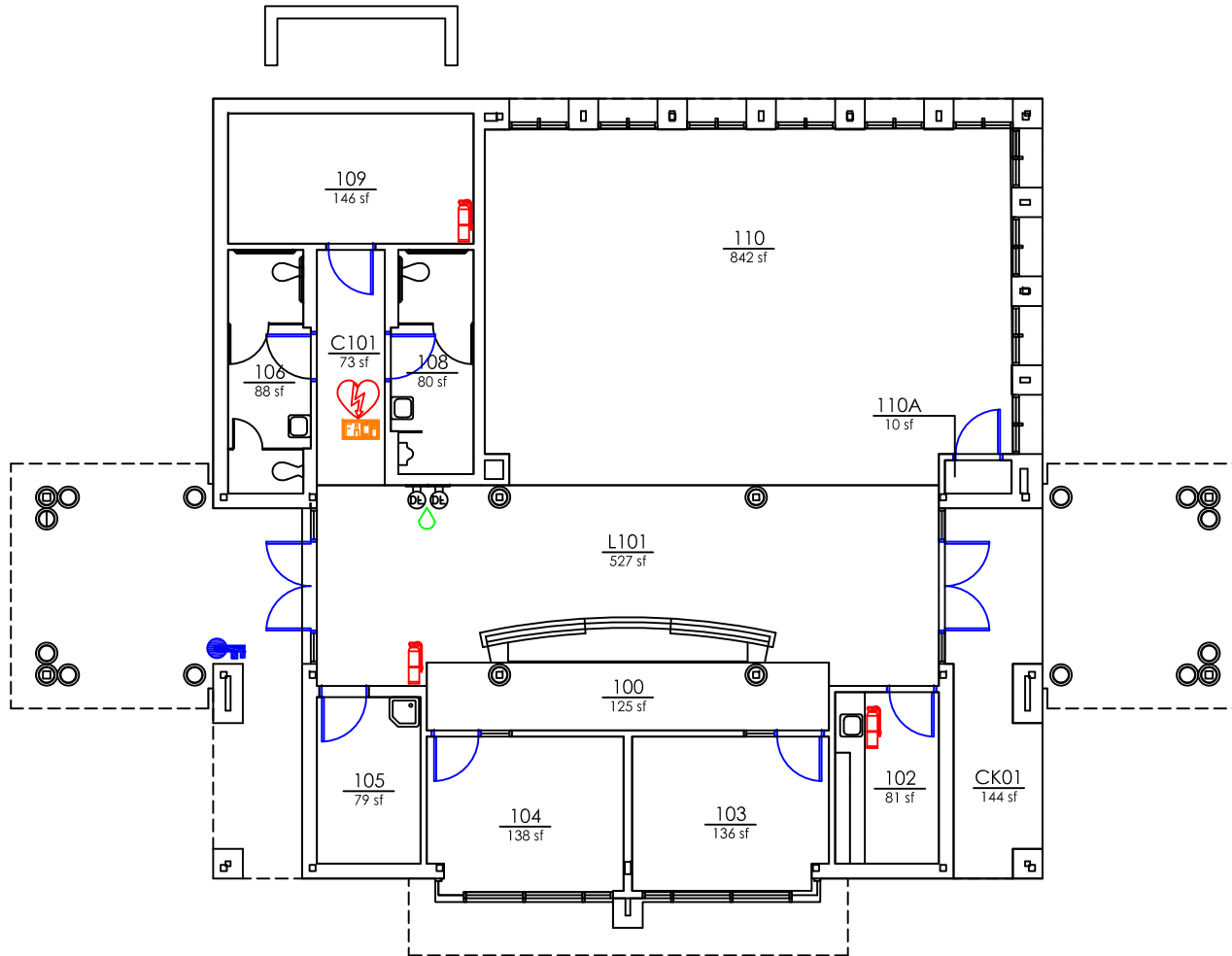
FLOOR
3



 FICM Code 210 Classroom
 FICM Code 110 Classroom

 = FIRE EXTINGUISHER  = AED  = FIRE DEP. CONNECTION  = LOCK BOX  = FIRE ALARM CONTROL PANEL  = SPRINKLER HEADER **R** = SPRINKLER RISER  = Bottle Filler

DATE REVISED
12/28/2020

ADDRESS
326 6th ST

Square Feet
2844

BLDG NO
1109

(VIS) VISITOR CENTER
FIRST FLOOR

FLOOR
1

DRAWINGS ARE NOT TO SCALE

MAIN FLOOR WOODWARD CONCESSIONS

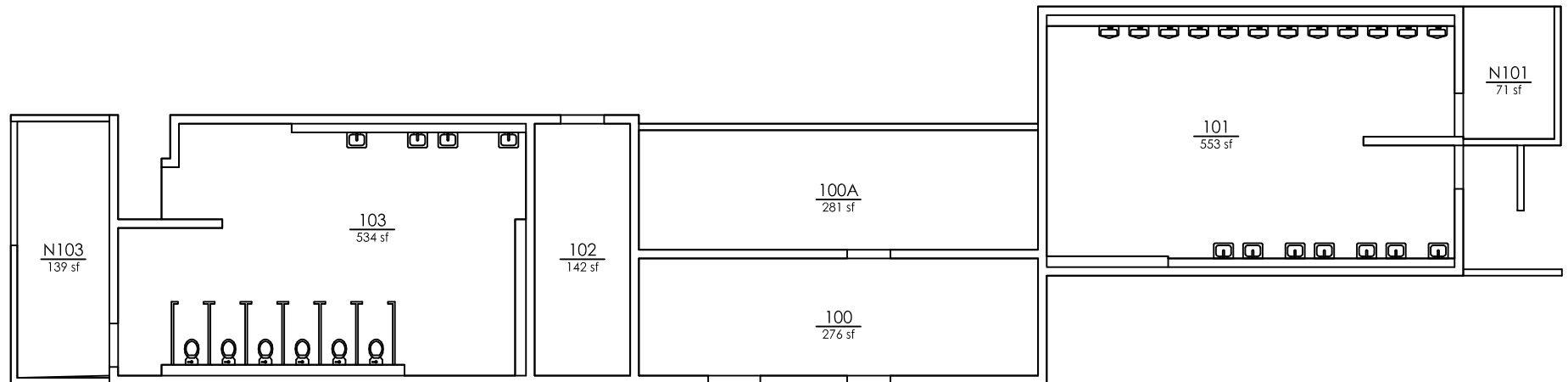



- FICM Code 210 Classroom
- FICM Code 110 Classroom

- = FIRE EXTINGUISHER
- = AED
- = FIRE DEP. CONNECTION
- = LOCK BOX
- = FIRE ALARM CONTROL PANEL
- = SPRINKLER HEADER
- = SPRINKLER RISER
- = Bottle Filler

DATE REVISED	ADDRESS	Square Feet	BLDG NO	(WCL) WOODWARD CONCESSION LOWER FLOOR PLAN	FLOOR 1
12/29/2020	1250 Swoop LN	2342	1370		

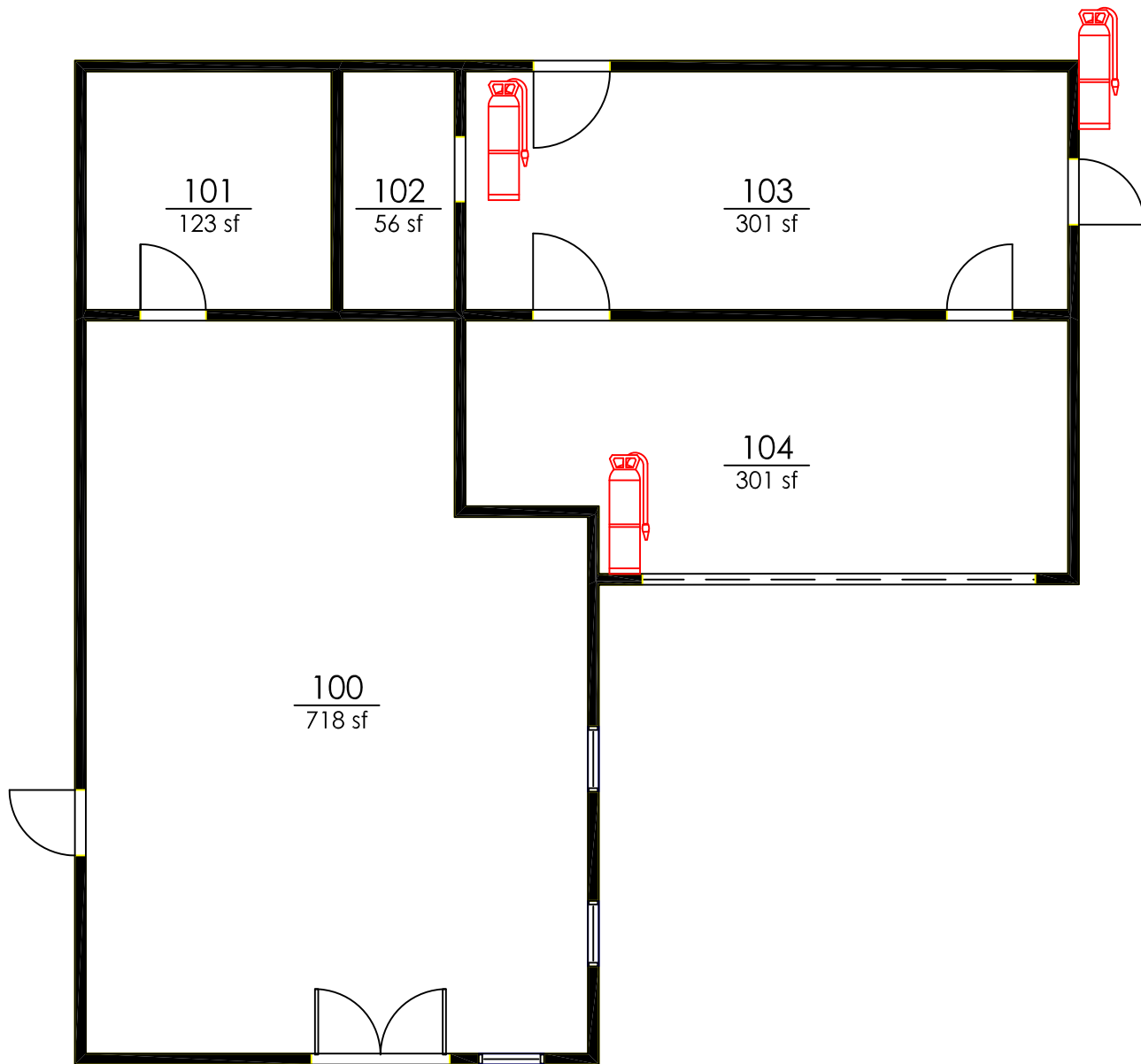
DRAWINGS ARE NOT TO SCALE



-  FICM Code 210 Classroom
-  FICM Code 110 Classroom

-  = FIRE EXTINGUISHER
-  = AED
-  = FIRE DEP. CONNECTION
-  = LOCK BOX
-  = FIRE ALARM CONTROL PANEL
-  = SPRINKLER HEADER
-  = SPRINKLER RISER
-  = Bottle Filler

DATE REVISED
1/1/2021

ADDRESS
1306 Washington
St

Square Feet
1632

BLDG NO
1371



(WCU) WOODWARD CONCESSIONS
UPPER FLOOR PLAN

FLOOR
1

DRAWINGS ARE NOT TO SCALE

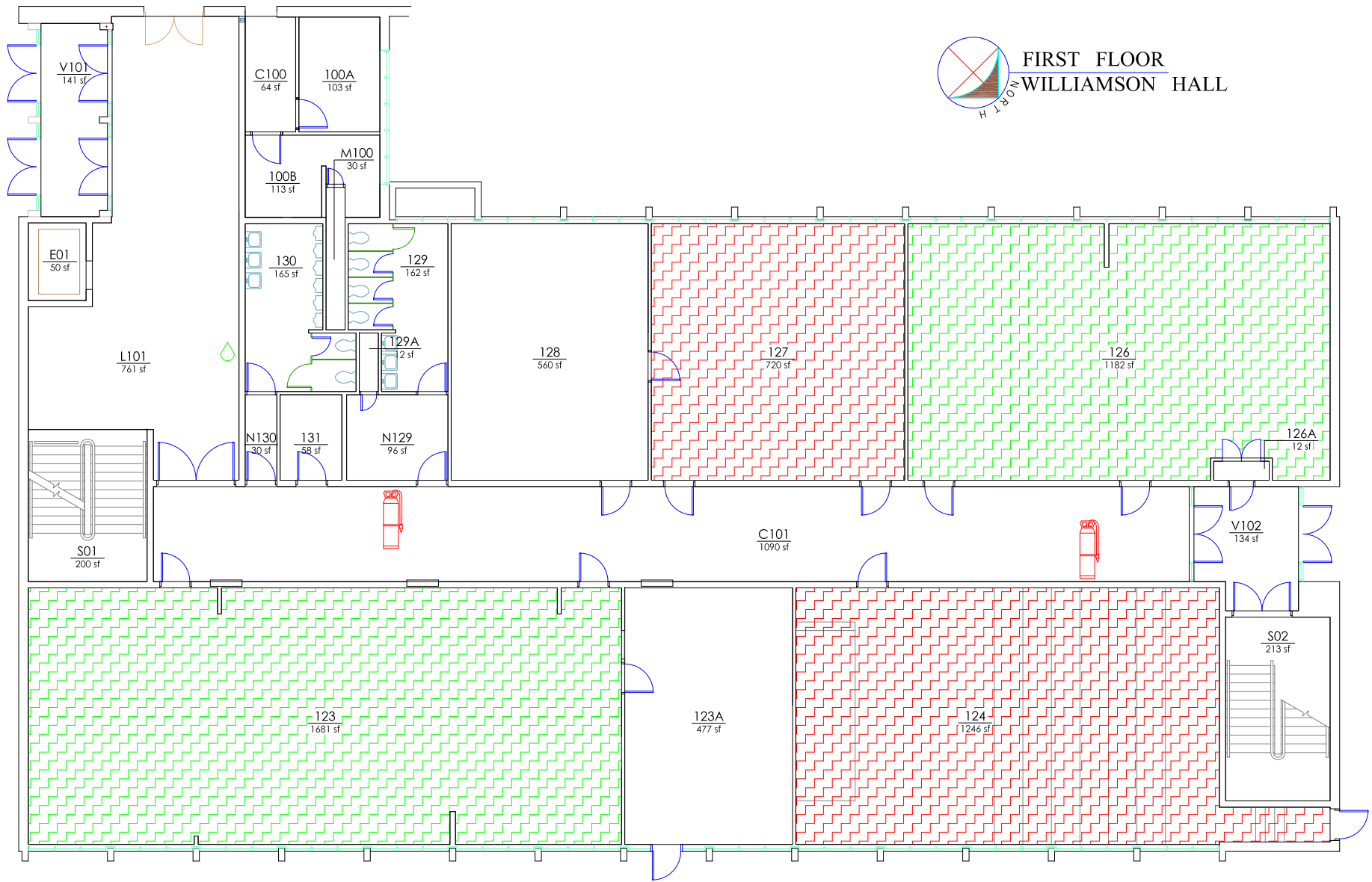
FIRST FLOOR
WILLIAMSON HALL



 FICM Code 210 Classroom
 FICM Code 110 Classroom

 = FIRE EXTINGUISHER  = AED  = FIRE DEP. CONNECTION  = LOCK BOX  = FIRE ALARM CONTROL PANEL  = SPRINKLER HEADER  = SPRINKLER RISER  = Bottle Filler

DATE REVISED 02/01/2022	ADDRESS 323 Media LN	Square Feet 10095	BLDG NO 1133	(WLM) WILLIAMSON HALL FIRST FLOOR	FLOOR 1
----------------------------	-------------------------	----------------------	-----------------	--------------------------------------	------------

DRAWINGS ARE NOT TO SCALE

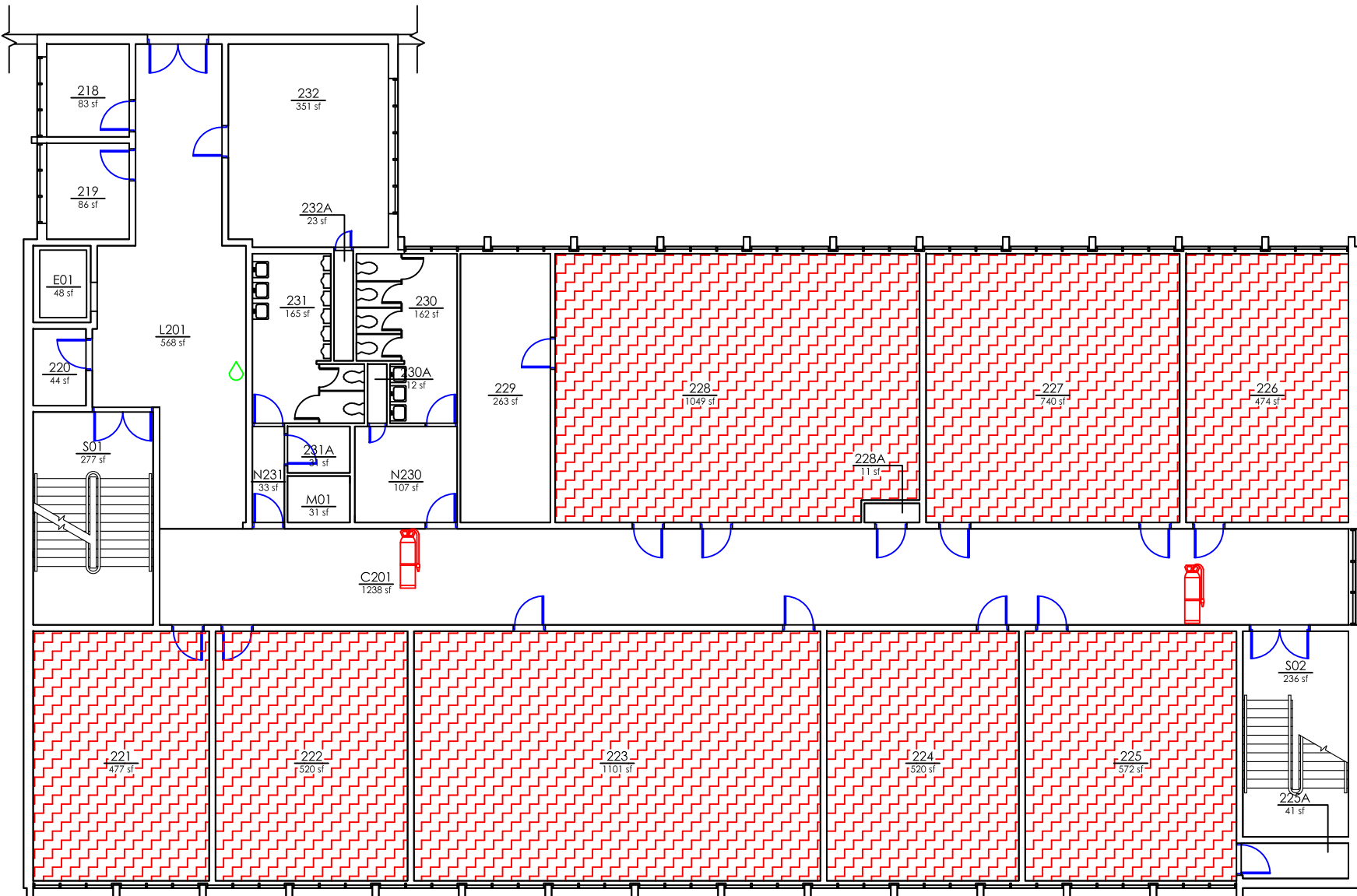

SECOND FLOOR
WILLIAMSON HALL

- FICM Code 210 Classroom
- FICM Code 110 Classroom

- = FIRE EXTINGUISHER
- = AED
- = FIRE DEP. CONNECTION
- = LOCK BOX
- = FIRE ALARM CONTROL PANEL
- = SPRINKLER HEADER
- = SPRINKLER RISER
- = Bottle Filler

DATE REVISED 07/21/2020	ADDRESS 323 Media LN	Square Feet 10136	BLDG NO 1133	(WLM) WILLIAMSON HALL SECOND FLOOR	FLOOR 2
----------------------------	-------------------------	----------------------	-----------------	---------------------------------------	------------

DRAWINGS ARE NOT TO SCALE

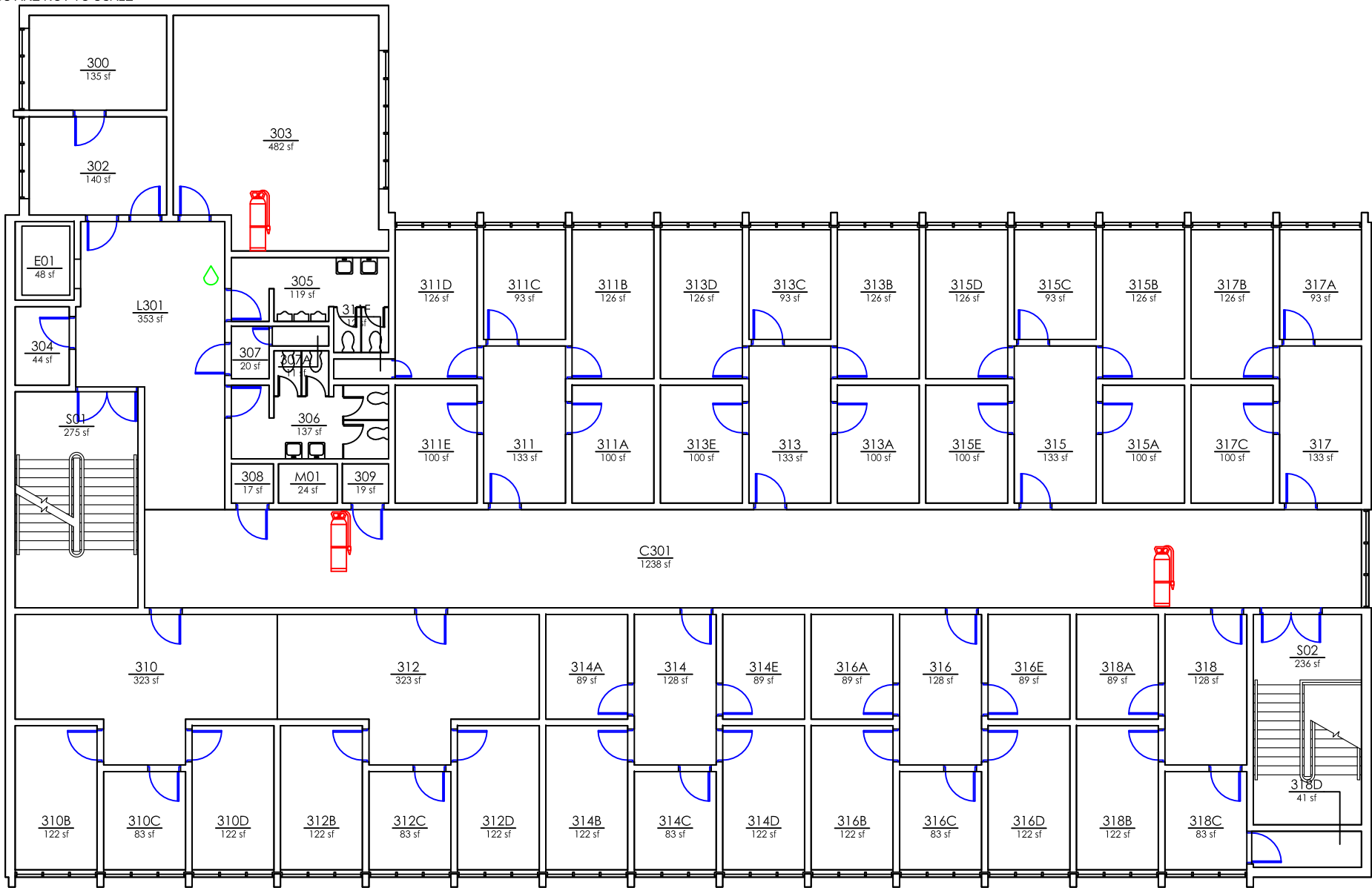

THIRD FLOOR
WILLIAMSON HALL

- FICM Code 210 Classroom
- FICM Code 110 Classroom

- = FIRE EXTINGUISHER
- = AED
- = FIRE DEP. CONNECTION
- = LOCK BOX
- = FIRE ALARM CONTROL PANEL
- = SPRINKLER HEADER
- = SPRINKLER RISER
- = Bottle Filler

DATE REVISED
07/21/2020

ADDRESS
323 Media LN

Square Feet
10114



BLDG NO
1133

(WLM) WILLIAMSON HALL
THIRD FLOOR

FLOOR
3

DRAWINGS ARE NOT TO SCALE



 FICM Code 210 Classroom
 FICM Code 110 Classroom

 = FIRE EXTINGUISHER  = AED  = FIRE DEP. CONNECTION  = LOCK BOX  = FIRE ALARM CONTROL PANEL  = SPRINKLER HEADER  = SPRINKLER RISER  = Bottle Filler

DATE REVISED 2/1/2022	ADDRESS 580 W. 7th St	Square Feet 35753	BLDG NO 1220	(WSP) WASHINGTON STATE PATROL CRIME LAB FIRST FLOOR	FLOOR 1
---------------------------------	---------------------------------	-----------------------------	------------------------	--	-------------------

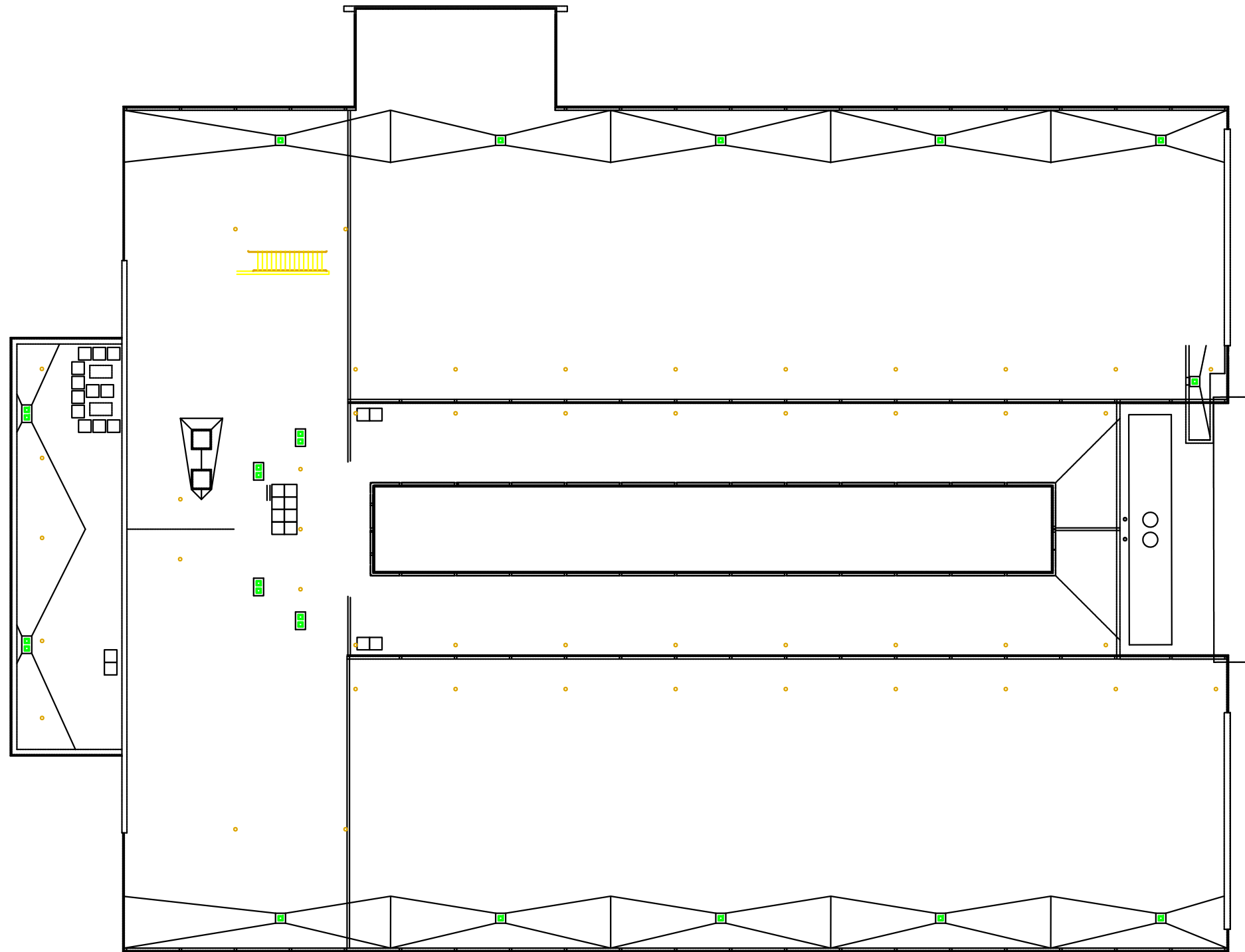

 = FIRE EXTINGUISHER
  = AED
  = FIRE DEP. CONNECTION
  = LOCK BOX
  = FIRE ALARM CONTROL PANEL
  = SPRINKLER HEADER
  = SPRINKLER RISER

DATE CREATED 02-01-22	ADDRESS 580 W. 7th Street	Square Feet	AiM ID 1220	(WSP) WASHINGTON STATE PATROL CRIME LAB ROOF	FLOOR
---------------------------------	------------------------------	-------------	----------------	---	-------

DRAWINGS ARE NOT TO SCALE

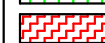

 FICM Code 210 Classroom
 FICM Code 110 Classroom

 = FIRE EXTINGUISHER
  = AED
  = FIRE DEP. CONNECTION
  = LOCK BOX
  = FIRE ALARM CONTROL PANEL
  = SPRINKLER HEADER
 R = SPRINKLER RISER
  = Bottle Filler

DATE REVISED 2/1/2022	ADDRESS 580 W. 7th St	Square Feet 2112	BLDG NO 1220	(WSP) WASHINGTON STATE PATROL CRIME LAB PENTHOUSE	FLOOR 2
--------------------------	--------------------------	---------------------	-----------------	--	------------

DRAWINGS ARE NOT TO SCALE

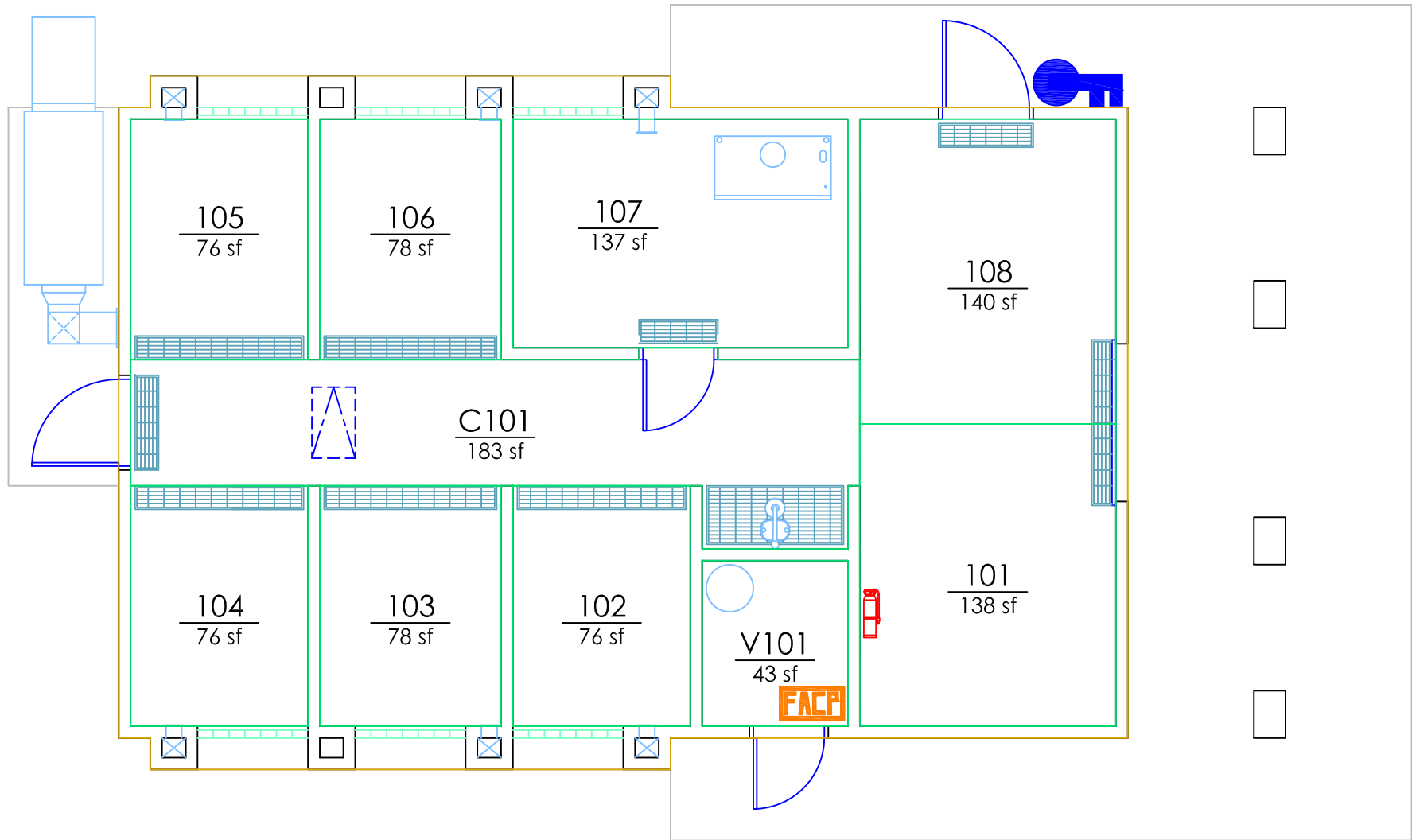

MAIN FLOOR
WASTE TRANSFER FACILITY

- FICM Code 210 Classroom
- FICM Code 110 Classroom

- = FIRE EXTINGUISHER
- = AED
- = FIRE DEP. CONNECTION
- = LOCK BOX
- = FIRE ALARM CONTROL PANEL
- = SPRINKLER HEADER
- = SPRINKLER RISER
- = Bottle Filler

DATE REVISED
1/3/2021

ADDRESS
1320 Woodward
Ln

Square Feet
1196

BLDG NO
1435

(WTF) WASTE TRANSFER FACILITY
FLOOR PLAN

FLOOR
1

MAIN FLOOR WOODWARD NORTH TOILETS

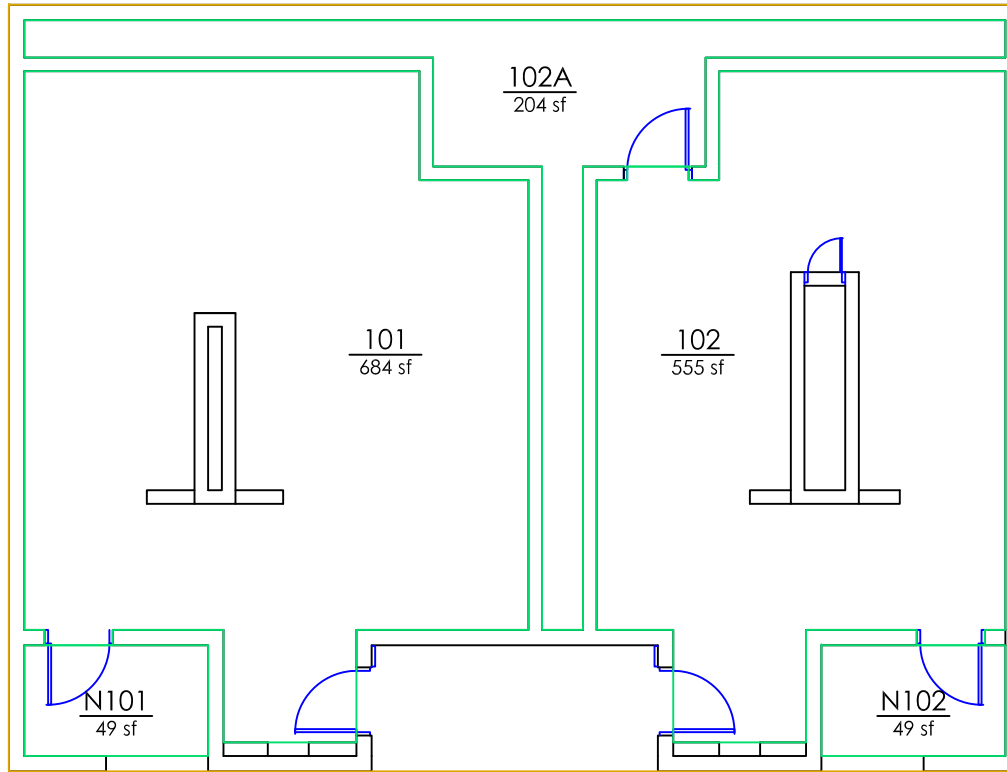
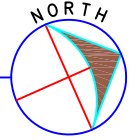



FICM Code 210 Classroom
 FICM Code 110 Classroom

= FIRE EXTINGUISHER
 = AED
 = FIRE DEP. CONNECTION
 = LOCK BOX
 = FIRE ALARM CONTROL PANEL
 = SPRINKLER HEADER
 R = SPRINKLER RISER
 = Bottle Filler

DATE REVISED	ADDRESS	Square Feet	BLDG NO	(WTN) WOODWARD STADIUM TOILETS NORTH	FLOOR
1/3/2021	1291 Playfield Ln	1856	1366		1

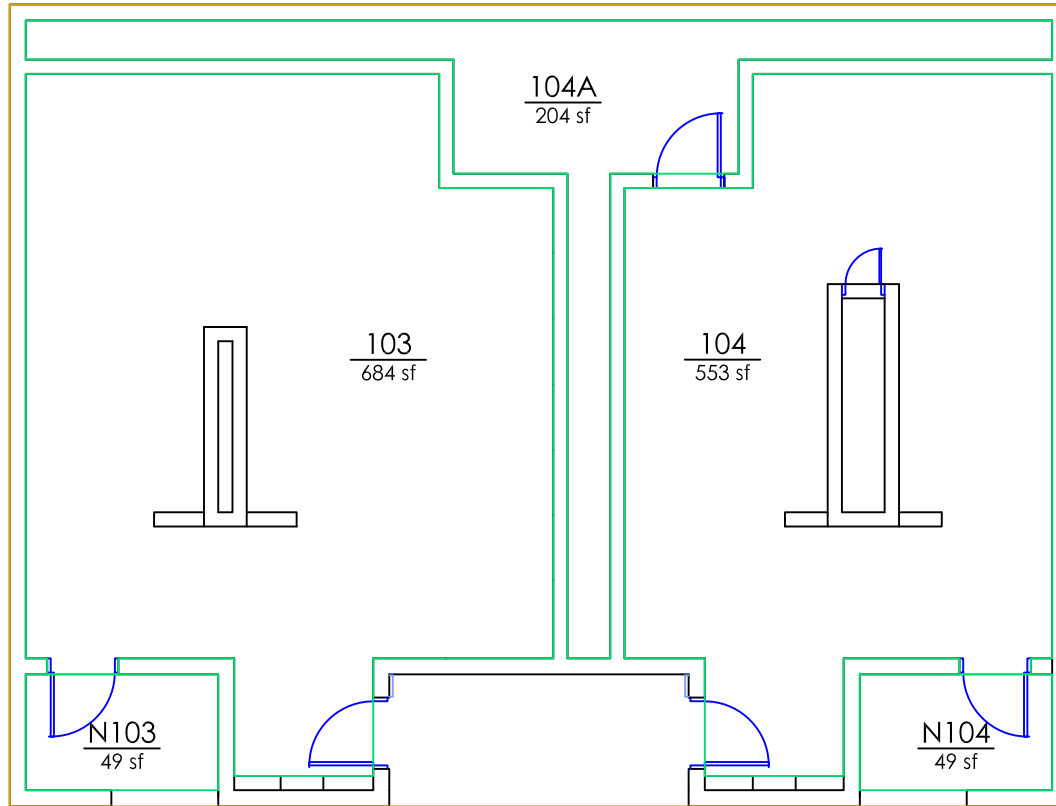
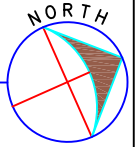
MAIN FLOOR WOODWARD SOUTH TOILETS



 FICM Code 210 Classroom
 FICM Code 110 Classroom

 = FIRE EXTINGUISHER
  = AED
  = FIRE DEP. CONNECTION
  = LOCK BOX
  = FIRE ALARM CONTROL PANEL
  = SPRINKLER HEADER
 R = SPRINKLER RISER
  = Bottle Filler

DATE REVISED
1/3/2021

ADDRESS
1263 Playfield Ln

Square Feet
1856

BLDG NO
1367

(WTS) WOODWARD STADIUM TOILET
SOUTH

FLOOR
1